



Made in U.S.A.

ASI 99070

ASI 99070

Zippo® COLLECTION

PROMOTIONAL PRODUCTS CATALOG

2002

Table of Contents

General Information

- General Information 2
- 7 Day Express 3
- Polycarbonate Chips 4
- Glow In The Dark 4

Knife Collection

- Cut-About Knives 5-8
- Z-Twin Knife 7-8
- Pocket Knife/Scissors 9-10
- Pocket Knife/Scissors
w/Money Clip 9-10
- Pocket Knives 11-12
- Pocket Knives
w/Money Clip 11-12

Metal Specialty

- Letter Openers 13-14
- Money Clips 13-14
- Tape Measures 15-16
- Greenskeeper™ Golf Tools 17-18
- Greenskeeper™ Golf Tools
w/Money Clip 17-18
- Key Rings 19-20
- Key Holders 21-22
- Belt Buckle 21-22
- Cigar Cutter 45

Windproof Lighters

- Regular Size
Windproof Lighters 23-26
- Anodized Aluminum
Windproof Lighters 27-28

Windproof Lighters

- Vintage Windproof Lighters 27-28
- Zippo Art Work Series
Windproof Lighters 29-30
- Surprise Windproof Lighters 31-32
- Slim Windproof Lighters 33-34
- After Hours Windproof Lighters 33-34

Writing Instruments

- Stylus Series Pens 35-36
- Performer Pens 37-38

Packaging Options

- Individual Tins 39
- Leatherman® Sets 40
- Dual Tins 40
- Combination Gift Sets 41
- Performer Pen
Combination Gift Sets 42
- Stylus Series Pen
Combination Gift Sets 43
- Combination Gift Sets Matrix 44
- Gift Kits 45
- Pouches 45

General Information

- Personalized Engraving 46
- Imprint Methods 47
- Computer Graphic Proofs 47
- Price Index 48
- Miscellaneous Information 48
- Electronic Art 48
- The World Famous
Zippo Guarantee Back Cover

•Products shown actual size, unless noted.



This year marks the 70th anniversary of an American icon. Seventy years ago, George G. Blaisdell set up shop in Bradford, Pennsylvania, and began to manufacture the Zippo windproof lighter.

Although little has changed in how we make Zippo lighters – after all, it's hard to improve on a design that works so well – we've expanded our product line to include tape measures, money clips, pocketknives, and a full line of personal gift items. Every Zippo product carries our assurance of American-made quality, and our guarantee that it works or we fix it free.

Fold out for

General information

General Information

General Information

The information on this page applies to most products shown in this catalog. Exceptions will be noted on individual product pages.

Imprint Charges

The price schedule includes the product with artwork on one surface in 1 or 2 colors, lustre etch, laser, or computer engraving. See imprint methods available on each product page.

Combination Order Pricing

When two or more product types are ordered with the same ad copy, the total quantity determines the price. Each product type must be ordered in its minimum quantity. Combined pricing is not available on performer pen combination sets.

Less Than Minimum Orders

Customer will be charged \$85 for each product ordered in less than minimum quantity. See product pages for minimum quantities. No order will be accepted for less than 50% of any established minimum quantity. (C)

Color Charge

For each additional color, add \$.75 per color, per surface, per unit. (C)

Custom Color Finish

Pantone color matching is available for Zytel® knife handles and matte finish products. Please call Zippo for minimum quantities, pricing, lead times, and other details.

Artwork Charges & Samples

NO CHARGE for artwork, screens, set-ups, or **one** pre-production sample. All ad copy requires preparation by our Art or Graphics department. Please submit the best reproduction quality ad copy you have.

- Pre-production proof-upon request, **one** sample is available at no charge. When two or more products with the same ad copy are ordered, please specify which one product is to be sampled.
- Color graphic proof - No charge
- Black and white fax proof - No charge
- E-mail proof - No charge
- Random sample - End quantity price
- Speculative sample - Contact your Zippo distributor for more information.

Personalization

An additional charge of \$2.67 per unit will be added for block lettering, initials, or consecutive numbering. Facsimile signature or script names will be charged at \$4.33 each. Personalization is not available on belt buckles, Zytel® knife handles, or the reverse side of any money clip product. (C)

Standard Lead Time (approximate working days)

- New or revised artwork with pre-production proof 23 days*
- New or revised artwork with computer graphic proof 18 days*
- New or revised artwork with faxed proof 15 days*
- New or revised artwork without a proof 12 days*
- Exact repeat order 9 days*
- 7 Day Express 7 days*

* Approval needed within 3 working days after receipt of proof. To qualify for the above lead times, you must meet these requirements:

- Catalog minimums apply (maximum 1000 pieces)
- Must be standard one or two color imprint, lustre etch, laser engraving, or computer engraving
- Imprint on one surface
- Standard packaging

For deadline orders, or any orders that do not qualify under the guidelines above, please call for quoted lead times.

Standard Packaging

Each product is individually gift boxed with the world-famous Zippo Guarantee. Optional packaging and combination gift set packaging is available upon request (See pages 39-45).

Overruns and Underruns

A 5% overrun or underrun will constitute fulfillment of the order. Invoice will reflect actual quantity shipped. If an exact quantity is requested, a surcharge of \$50 will be added. (Z)

Terms/Shipping

Net 30 days, F.O.B. Bradford, PA, USA, on approval of credit. If you want Zippo to invoice your customer directly, please submit credit information and phone numbers for new accounts. Products will be shipped UPS, unless otherwise specified. (5C)



7 DAY EXPRESS

Any product that can be surface imprinted or laser engraved is available in Zippo's Express Delivery Program

Lead Time

Seven (7) working days from receipt of order. Orders must be received at Zippo before 12 noon Eastern Time. If order is received after 12 noon, please add one day to lead time.

Express Service --- Handling Charge

\$50.00 per product. (Z)

Maximum Quantity

250 total pieces. Please contact Zippo for product availability on quantities exceeding 250 pieces.

Minimum Quantity

Catalog minimums apply.

Surfaces

Price includes imprint on one surface only. Please contact Zippo on availability and cost for adding a second surface imprint.

Imprint Charges

Price includes one (1) color surface imprint or laser engraving only. Please contact Zippo on availability for additional color(s).

Shipping Method

United Parcel Service (UPS) ground unless otherwise specified. F.O.B. Bradford, Pennsylvania.

Samples

Product samples or paper proofs are not available through this program. We will fax a copy of the artwork prepared at 100% and reduced to size if the order is marked to do so. Faxed approval must be received back within 1 hour.

Identification

Orders must be clearly marked "7 DAY EXPRESS".



Polycarbonate Imprint

Photo quality four color imprint capability is now a reality on Zippo windproof lighters. By transferring a photo image digitally onto a special polycarbonate plastic substrate, we are able to show exact replication of your design. The copy sent to Zippo is exactly what will appear on the lighter with a semi-gloss wear resistant finish.

POLYCARBONATE CHIP

Model	Description	250	500	1,000	2,500	10,000
#200	Brush Chrome Lighter	24.42	18.16	14.86	12.86	12.21
*	All Matte Finish Lighters	26.42	20.16	16.86	14.86	14.21

- Process not available on Black Crackle, Vintage, Antique or REALTREE HARDWOODS® finishes.
- Call Zippo for pricing on finishes not listed above.

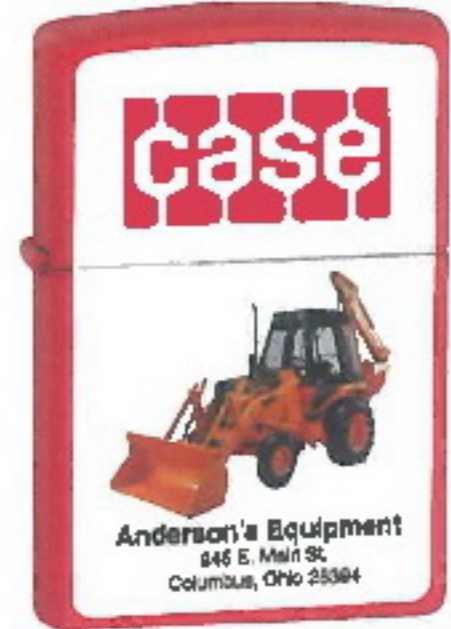

Exceptions

General information listed on page 2 does not apply to this process.

No less than minimum orders.

Additional Charges

Graphic proof available atno charge
 Pre-production sample charge \$800.00 (Z)
 Art preparation charge\$250.00 (Z)
 Production set up charge\$250.00 (Z)

Glow In The Dark Imprint

Special Permaglow™ powders create a luminescent effect that glows in the dark. "Unique" best describes this new process. Currently five special colors have been tested and are ready for immediate ordering: Chartreuse Glow, Green Glow, Pink Glow, Natural Blue Glow and Orange Glow. One minute of exposure to a 40 watt light allows these special colors to glow for approximately three hours.

GLOW IN THE DARK COLORS

Add the following charge to the price from any matrix in the catalog:

First Glow In The Dark Color	.83
Each Additional Glow Color	.83
	(C)

Exceptions

Color charge information listed on page 2 does not apply to this process.

A pre-production sample must be shown to customer before final production.

Colors Available

Chartreuse Glow
 Green Glow
 Orange Glow
 Pink Glow
 Natural Blue Glow



Design in daylight



Design in the dark

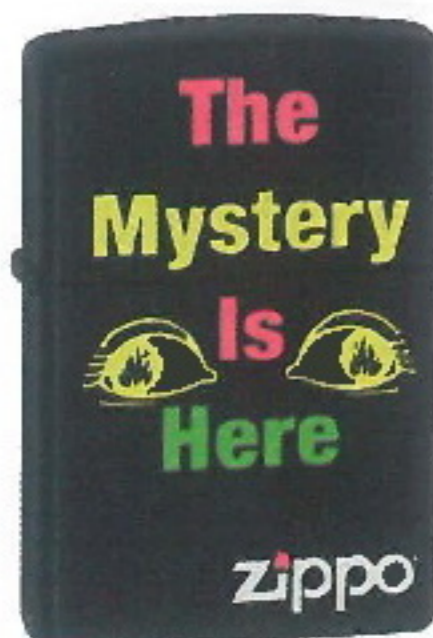

Cut-About Knives

Cut-About Knives

- Reward employee performance
- Say "thank you" for orders
- Advertise new locations
- Serve as safety rewards
- Promote with tie-ins:
 - *Our technology is cutting edge*
 - *Sharpen your image with . . .*
 - *Regain the winning edge*

Cut-About Features

- *Razor-sharp 2 1/4" Tru-Sharp™ stainless steel blade*
- *Stainless steel handle with lock-blade safety feature*
- *Weight: 2 oz.*
- *Made in U.S.A.* 

Cut-About Lite Features

- *Razor-sharp 2 1/4" Tru-Sharp™ stainless steel blade*
- *Tough, lightweight Zytel® handle with lock-blade safety feature*
- *Hole for keyring attachment*
- *Weight: 1 oz.*
- *Made in U.S.A.* 

CUT-ABOUT KNIVES

Model	Description	25	100	250	500	1000
Cut-About—Full Size (shipping wt. 25 per carton: 7 lbs. 12 oz.)						
7200	Brush Stainless	23.38	22.97	22.53	22.35	22.18
	second surface ad copy	2.63	2.22	1.78	1.60	1.43
Cut-About Lite—Full Size (shipping wt. 25 per carton: 5 lbs. 8 oz.)						
7000	Black Zytel®	17.93	17.52	17.08	16.90	16.73
7050	Orange Zytel®	17.93	17.52	17.08	16.90	16.73
7051	Realtree Hardwoods® Zytel®	22.38	21.97	21.53	21.35	21.18
7052	Reflex Blue Zytel®	17.93	17.52	17.08	16.90	16.73
7053	Green Zytel®	17.93	17.52	17.08	16.90	16.73
7054	Khaki Zytel®	17.93	17.52	17.08	16.90	16.73
	second surface ad copy	2.63	2.22	1.78	1.60	1.43
Leather Sheath (shipping wt. 25 per carton: 2 lbs.)						
7280	Leather Sheath plain	3.30	3.30	3.30	3.30	3.30
7280I	Leather Sheath w/laser logo	5.93	5.52	5.08	4.90	4.73
	second surface ad copy	2.63	2.22	1.78	1.60	1.43

• All of the above can be packaged in a gift set with a plain or custom imprinted sheath.

Exception

No personalization on Zytel® handles or leather sheath.

Imprint Methods

	EP	SI	LE	LA	AE
Cut-About Knives and Sheath (7200 Series)					
Brush Stainless	X	X	X	X	X
Leather Sheath				X	
Cut-About Lite Knives (7000 Series)					
Zytel® Handles			X		
EP = Etch and Paint	SI = Surface Imprint		LA = Laser Engraving		
LE = Lustre Etch			AE = Computer Engraving		

Imprint Areas



Cut-About Lite

Full Sized Cut-About

Full-sized Cut-About

7200
Brush Stainless



OVER 2 MILLION SOLD
SINCE INTRODUCTION

72801
Leather Sheath
(shown with
laser logo on
two surfaces)



(not shown actual size)

Full-sized Cut-About Lite

(not shown actual size)



7000
Black Zytel®



7050
Orange Zytel®

7051
REALTREE
HARDWOODS®
Zytel®

7052
Reflex Blue Zytel®

7053
Green Zytel®

7054
Khaki Zytel®

© Jordan Outdoor Enterprises, Ltd.- 1998

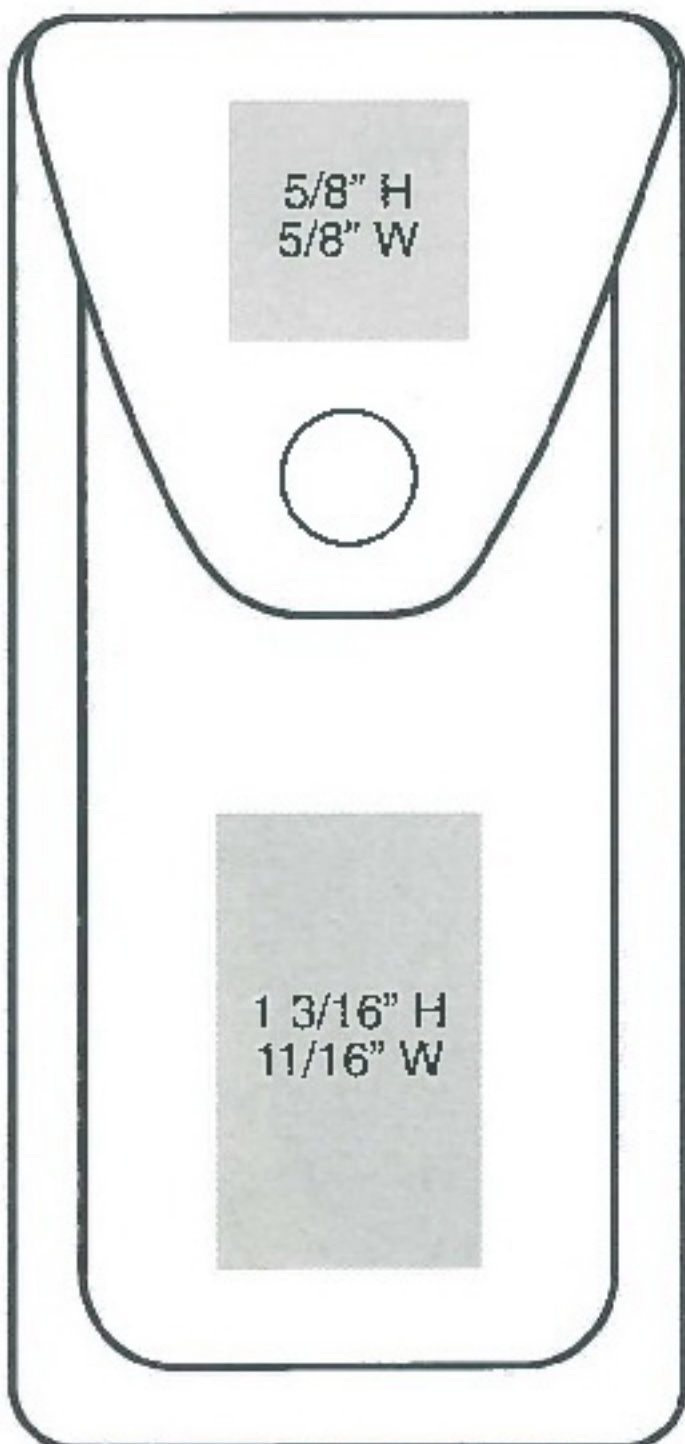

Knife Sheath



7200/7280 Combination Gift Set
Brush Stainless with Plain Sheath
(Laser engraving on sheath available
at additional cost)



Standard
Packaging

7050
Orange Zytel®

7 DAY EXPRESS

All items on this page available for
7 Day Express. See Page 3 for details.

Z-Twin and Cut-About Jr. Knives

Z-Twin and Cut-About Jr. Knives

- Open new sales promotions
- Advertise to new customers
- Reward employee performance
- Tie in with sales messages:
 - *Carve your mark . . .*
 - *Whittle away at the competition . . .*

Z-Twin Features

- Exclusive patented design by master knife craftsman Durvyn Howard Patent #5,125,157
- Two locking mechanisms
- Sleek, trim profile
- Durable Tru-Sharp™ stainless steel lock blade
- Weighs 1.75 oz.; 2 3/8" blade
- Quick release implement can be used to:
 - Untangle knots
 - Reset recessed electronics buttons
 - Repair nets
 - Repair torn sails and sports gear
 - Remove staples
 - Attach to key ring with optional split ring
- Made in U.S.A. 

Cut-About Jr. Features

- Razor-sharp 1 3/4" Tru-Sharp™ stainless steel blade
- Stainless steel handle with lock-blade safety feature
- Weight: 1 oz.
- Made in U.S.A. 

Z-TWIN AND CUT-ABOUT JR. KNIVES

Model	Description	25	100	250	500	1000
Z-Twin (shipping wt. 25 per carton: 3 lbs. 14 oz.)						
7262	Z-Twin	23.85	23.44	23.00	22.82	22.65
	second surface ad copy	2.63	2.22	1.78	1.60	1.43
Cut-About Jr. (shipping wt. 25 per carton: 4 lbs. 2 oz.)						
7105	Brush Stainless	21.20	20.78	20.35	20.17	20.00
	second surface ad copy	2.63	2.22	1.78	1.60	1.43
Cut-About Lite Jr. (shipping wt. 25 per carton: 3 lbs. 2 oz.)						
7151	Realtree Hardwoods® Zytel®	20.88	20.47	20.03	19.85	19.68
7170	Black Zytel®	17.26	16.85	16.41	16.23	16.06
	second surface ad copy	2.63	2.22	1.78	1.60	1.43

Cut-About Lite Jr. Features

- Razor-sharp 1 3/4" Tru-Sharp™ stainless steel blade
- Tough, lightweight Zytel® handle with lock-blade safety feature
- Hole for key ring attachment
- Weight: .5 oz.
- Made in U.S.A. 

Exceptions

No personalization on Zytel® handles.

Imprint Methods

	EP	SI	LE	LA	AE
Z-Twin & Cut-About Jr. Knives (7262 & 7105)					
Brush Stainless		X	X	X	X
Cut-About Lite Jr. Knives (7170, 7151)					
Zytel® Handles			X		
EP = Etch and Paint	SI = Surface Imprint		LA = Laser Engraving		
LE = Lustre Etch				AE = Computer Engraving	



Z-Twin
Standard Packaging

Imprint Areas

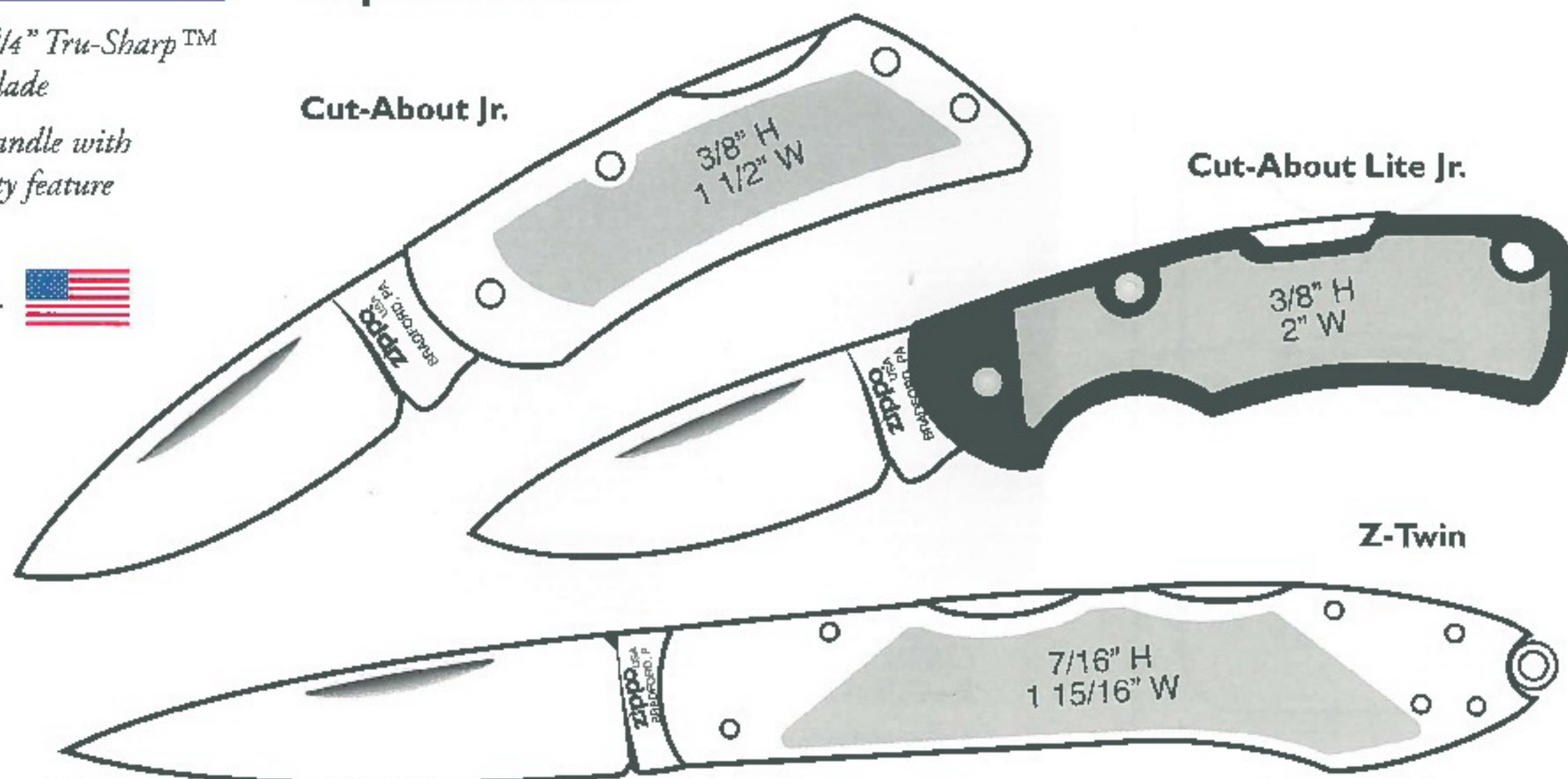

Patented Z-Twin Knife



7262
Z-Twin



Exclusive quick release implement, with optional split ring (Key ring not included.)



Cut-About Jr.



7105
Brush Stainless

Cut-About Lite Jr.



7170
Black Zytel®

Cut-About Jr.
Standard Packaging



7170
Black Zytel®



7151
REALTREE
HARDWOODS®
Zytel®

© Jordan Outdoor Enterprises, Ltd.- 1998

7 DAY EXPRESS

All items on this page available for 7 Day Express. See Page 3 for details.

Pocket Knife/Scissors

Pocket Knife/Scissors

- Recognize vendors
- Commemorate special events
- Enhance on-pack premium
- Reward employee performance
- Forecasting incentive
- Track record-breaking events
- A perfect combination

Features

- Trim, compact design
- Durable stainless steel 1 1/2" blade
- Functional quality scissors
- Nail file/screwdriver tip
- Optional money clip
- Optional split ring for key holder attachment
- Individual gift box
- Made in U.S.A. 

POCKET KNIFE/SCISSORS

Model	Description	25	100	250	500	1000
Knife/Scissors w/Split Ring (shipping wt. 25 per carton: 4 lbs.)						
7300	Brush Stainless	16.60	16.19	15.75	15.57	15.40
7300G	Brush Gold	20.60	20.19	19.75	19.57	19.40
7318	Black Matte	17.26	16.85	16.41	16.23	16.06
7333	Red Matte	17.26	16.85	16.41	16.23	16.06
7337	Purple Matte	17.26	16.85	16.41	16.23	16.06
7339	Navy Blue Matte	17.26	16.85	16.41	16.23	16.06
second surface ad copy		2.63	2.22	1.78	1.60	1.43
Knife/Scissors (shipping wt. 25 per carton: 4 lbs.)						
7500	Brush Stainless	16.60	16.19	15.75	15.57	15.40
7500G	Brush Gold	20.60	20.19	19.75	19.57	19.40
7518	Black Matte	17.26	16.85	16.41	16.23	16.06
7533	Red Matte	17.26	16.85	16.41	16.23	16.06
7537	Purple Matte	17.26	16.85	16.41	16.23	16.06
7539	Navy Blue Matte	17.26	16.85	16.41	16.23	16.06
second surface ad copy		2.63	2.22	1.78	1.60	1.43
Knife/Scissors w/Money Clip (shipping wt. 25 per carton: 4 lbs. 4 oz.)						
7500MC	Brush Stainless	17.26	16.85	16.41	16.23	16.06
7500GMC	Brush Gold	21.26	20.85	20.41	20.23	20.06
7518MC	Black Matte	17.93	17.52	17.08	16.90	16.73
7533MC	Red Matte	17.93	17.52	17.08	16.90	16.73
7537MC	Purple Matte	17.93	17.52	17.08	16.90	16.73
7539MC	Navy Blue Matte	17.93	17.52	17.08	16.90	16.73

Exception

No imprint or personalization available on reverse side of 7500MC series.

Imprint Methods

	EP	SI	LE	LA	AE
Pocket Knife/Scissors (7300 & 7500 Series)					
Brush Stainless	X	X	X	X	X
Gold		X	X	X	X
All Matte Finishes		X		X	X
EP = Etch and Paint	LA = Laser Engraving				
SI = Surface Imprint	AE = Computer Engraving				
LE = Lustre Etch					

Standard Packaging

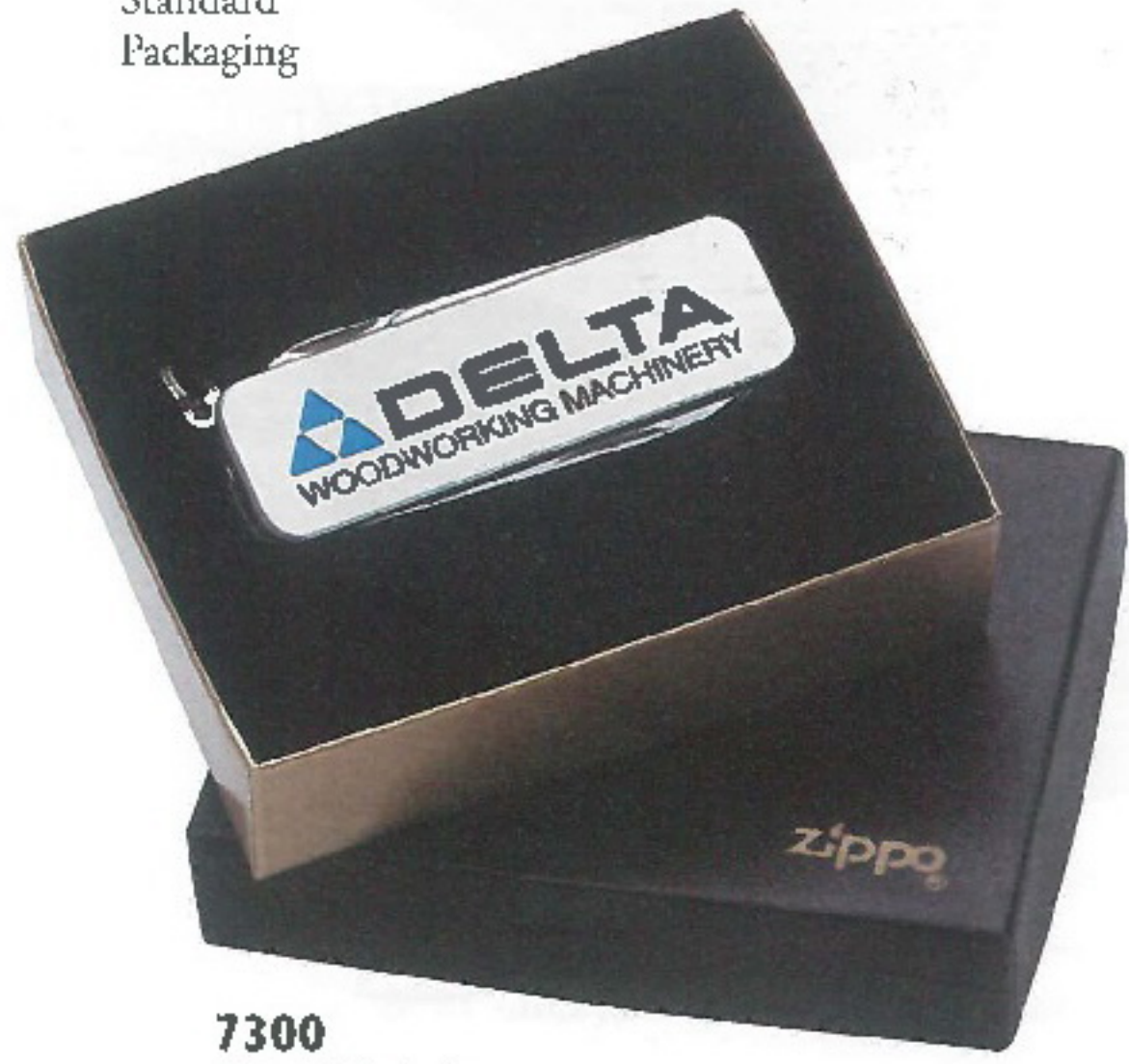

7300
Brush Stainless
with split ring

Imprint Areas

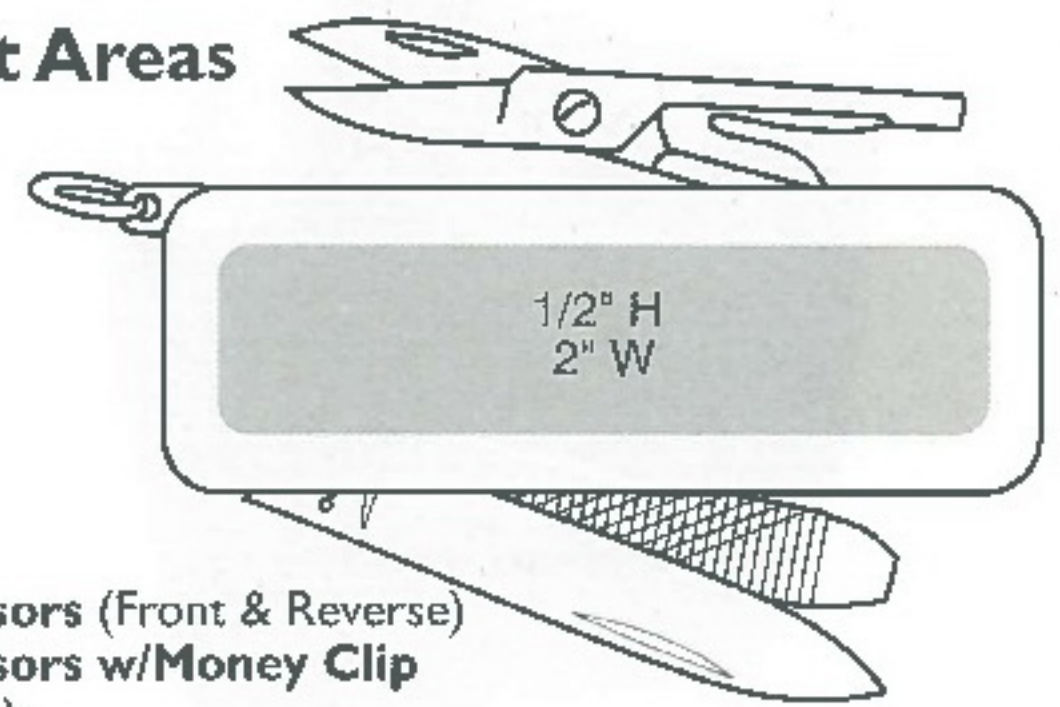

Knife/Scissors (Front & Reverse)
Knife/Scissors w/Money Clip (Front Only)



7333
Red Matte
with split ring



7300
Brush Stainless
with split ring

7300G
Brush Gold
with split ring

7318
Black Matte
with split ring

7337
Purple Matte
with split ring

7339
Navy Blue Matte
with split ring



7500G
Brush Gold

7518
Black Matte

7533
Red Matte

7537
Purple Matte

7539
Navy Blue Matte

7500GMC
Brush Gold
with money clip

7518MC
Black Matte
with money clip

7533MC
Red Matte
with money clip

7537MC
Purple Matte
with money clip

7539MC
Navy Blue Matte
with money clip



7500
Brush Stainless

7500MC
Brush Stainless
with money clip



Pocket Knives

Pocket Knives

- Advertise to new clients
- Reward company sports leagues
- Open new sales promotions
- Promote sales messages with tie-ins:
 - *We've honed our services for fast delivery*
 - *Cut through the red tape with...*

Features

- Flat, thin stainless steel design
- Soft rounded edges to minimize pocket wear
- Light weight
- 1 1/2" cutting blade
- Nail file
- Individual gift box
- Made in U.S.A. 

Imprint Areas

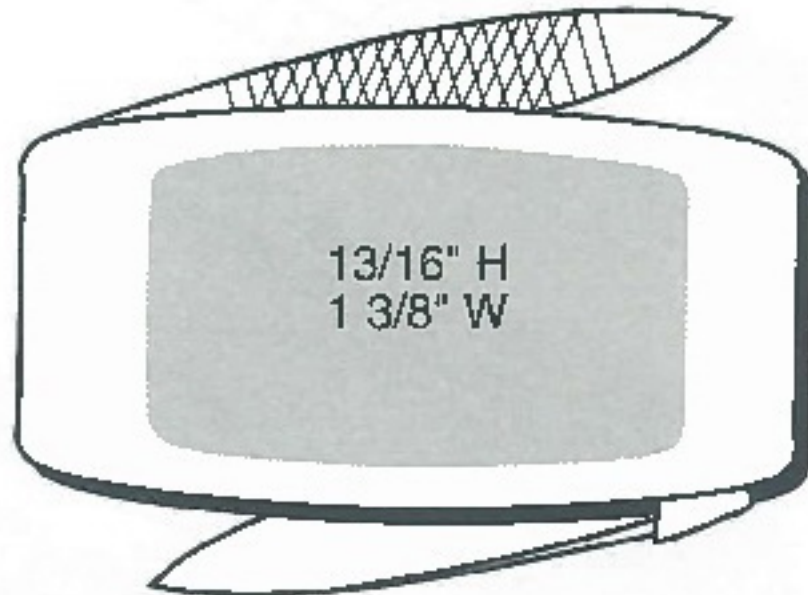

Pocket Knife
Pocket Knife
w/Money Clip

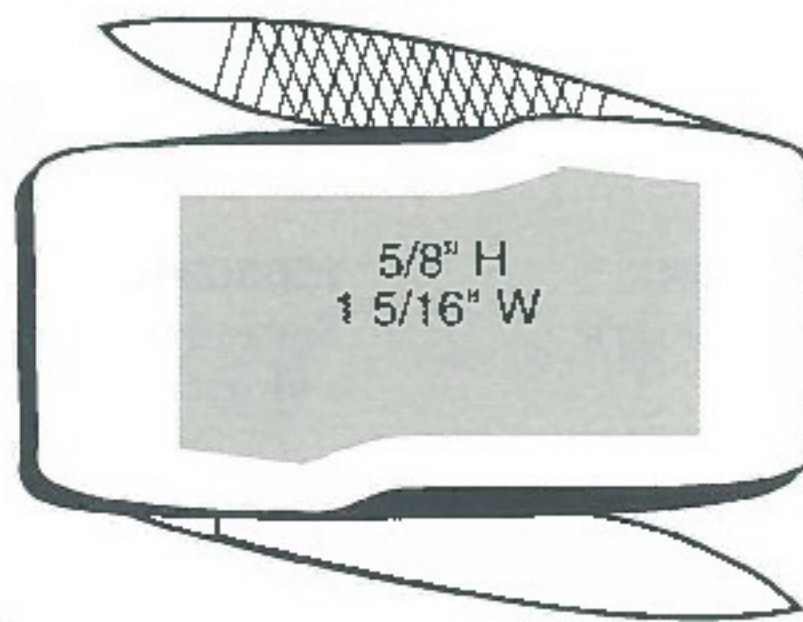

Pocket Knife Reverse



POCKET KNIVES

Model	Description	50	100	250	500	1000
Pocket Knives (shipping wt. 50 per carton: 5 lbs. 14 oz.)						
7600	Brush Stainless	9.63	9.22	8.78	8.60	8.43
7600G	Brush Gold	12.96	12.55	12.11	11.93	11.76
7618	Black Matte	10.30	9.89	9.45	9.27	9.10
7633	Red Matte	10.30	9.89	9.45	9.27	9.10
7637	Purple Matte	10.30	9.89	9.45	9.27	9.10
7639	Navy Blue Matte	10.30	9.89	9.45	9.27	9.10
second surface ad copy		2.63	2.22	1.78	1.60	1.43
Pocket Knives w/Money Clip (shipping wt. 50 per carton: 6 lbs. 4 oz.)						
7800	Brush Stainless	10.30	9.89	9.45	9.27	9.10
7800G	Brush Gold	13.63	13.22	12.78	12.60	12.43
7818	Black Matte	10.96	10.55	10.11	9.93	9.76
7833	Red Matte	10.96	10.55	10.11	9.93	9.76
7837	Purple Matte	10.96	10.55	10.11	9.93	9.76
7839	Navy Blue Matte	10.96	10.55	10.11	9.93	9.76

Exception

No imprint or personalization available on reverse side of 7800 series.

Imprint Methods

	EP	SI	LE	LA	AE
Pocket Knives (7600 & 7800 Series)					
Brush Stainless	X	X	X	X	X
Brush Gold		X	X	X	X
All Matte Finishes		X		X	X
EP = Etch and Paint	SI = Surface Imprint		LA = Laser Engraving		
LE = Lustre Etch				AE = Computer Engraving	

Standard Packaging



7600G
Brush Gold

Pocket Knives and Pocket Knives with Money Clip



7600
Brush Stainless

7800
*Brush Stainless
with money clip*



7600G
Brush Gold

7800G
*Brush Gold
with money clip*



7618
Black Matte

7818
*Black Matte
with money clip*



7633
Red Matte

7833
*Red Matte
with money clip*



7637
Purple Matte

7837
*Purple Matte
with money clip*



7639
Navy Blue Matte

7839
*Navy Blue Matte
with money clip
(shown)*

Letter Openers & Money Clips

LETTER OPENERS AND MONEY CLIPS

Model	Description	25	100	250	500	1000
-------	-------------	----	-----	-----	-----	------

Letter Openers (shipping wt. 25 per carton: 3 lbs.)

7561	7" Letter Opener	11.00	10.58	10.15	9.97	9.80
7562	6 1/4" Letter Opener	11.25	10.83	10.40	10.22	10.05

second surface ad copy		2.63	2.22	1.78	1.60	1.43
------------------------	--	------	------	------	------	------

Model	Description	50	100	250	500	1000
-------	-------------	----	-----	-----	-----	------

Money Clips (shipping wt. 50 per carton: 4 lbs.)

7400	Brush Stainless	5.40	4.99	4.55	4.37	4.20
7418	Black Matte	5.40	4.99	4.55	4.37	4.20
7433	Red Matte	5.40	4.99	4.55	4.37	4.20
7437	Purple Matte	5.40	4.99	4.55	4.37	4.20
7439	Navy Blue Matte	5.40	4.99	4.55	4.37	4.20

Letter Openers and Money Clips

- Say "thank you" for orders
- Keep your company name in front of buyers
- Serve as an employee reward
- Utilize thematic tie-ins:
 - *Opening new opportunities*
 - *Save money with . . .*
 - *Open the lines of communication*

Letter Opener Features

- Sleek, modern profile
- All metal stainless steel construction
- High quality sharp cutting edge
- Double-edged opener comfortable for left or right-handed operation
- Made in U.S.A. 

Money Clip Features

- Lightweight design
- High-tension spring steel
- Variety of finishes
- Ideal for pocket or purse
- Individual gift box
- Made in U.S.A. 

Imprint Areas

Money Clip

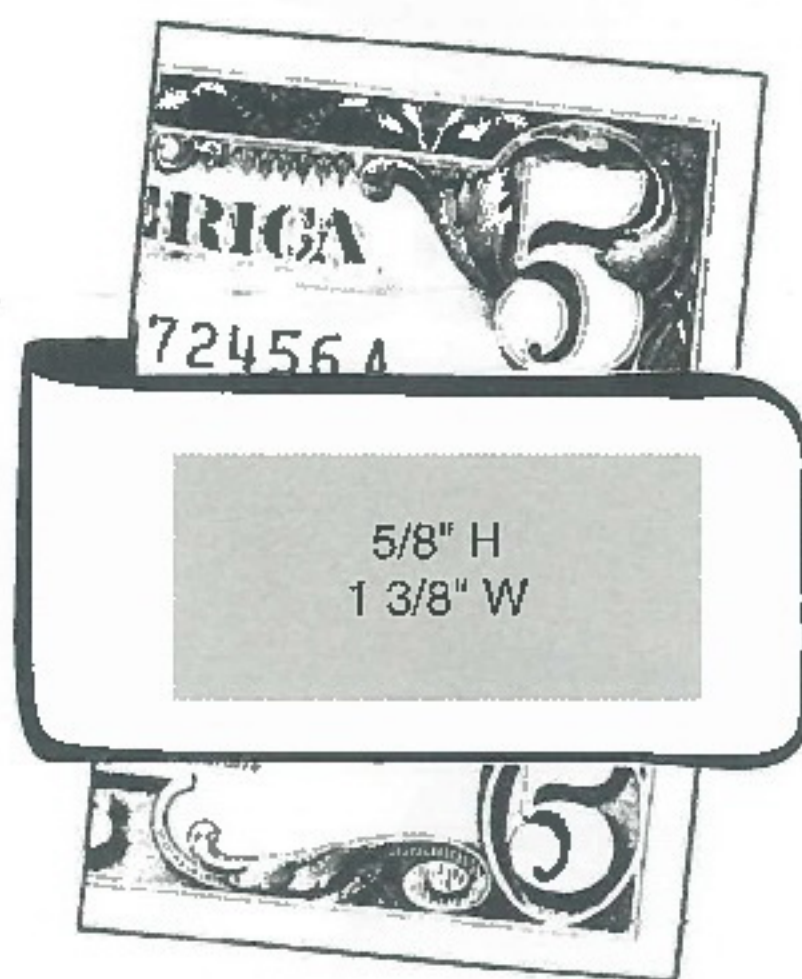

5/8" H
1 3/8" W

Imprint Methods

	EP	SI	LE	LA	AE
Letter Openers (7561 and 7562 Series)					
Brush Stainless		X		X	X
Money Clips (7400 Series)					
Brush Stainless	X	X	X	X	X
All Matte Finishes		X		X	X
EP = Etch and Paint	LA = Laser Engraving				
SI = Surface Imprint	AE = Computer Engraving				
LE = Lustre Etch					

Exception

Deluxe gift box for letter openers available at \$1.75. (C)

No imprint or personalization on reverse side of 7400 series.

7562 Letter Opener

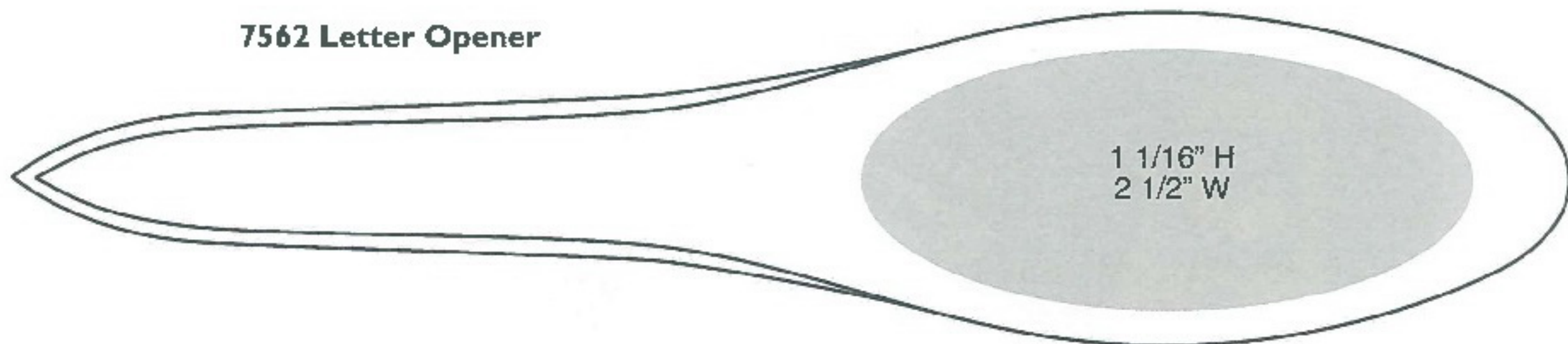

1 1/16" H
2 1/2" W

7561 Letter Opener

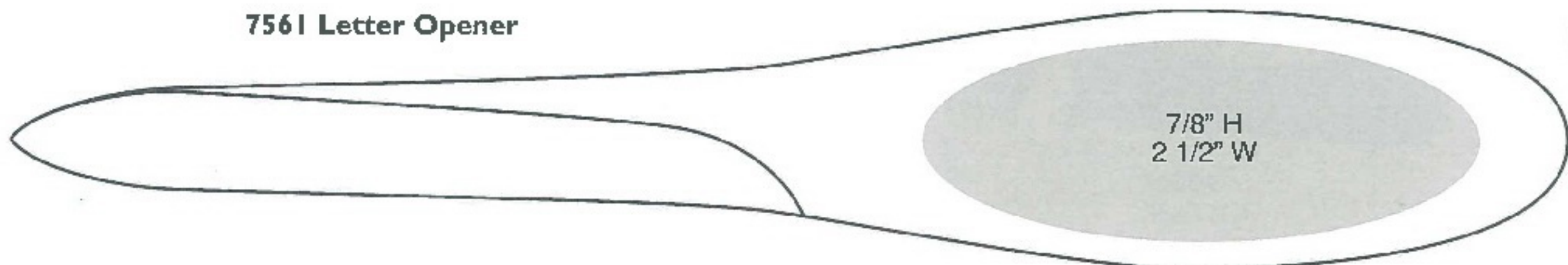

7/8" H
2 1/2" W

Letter Openers

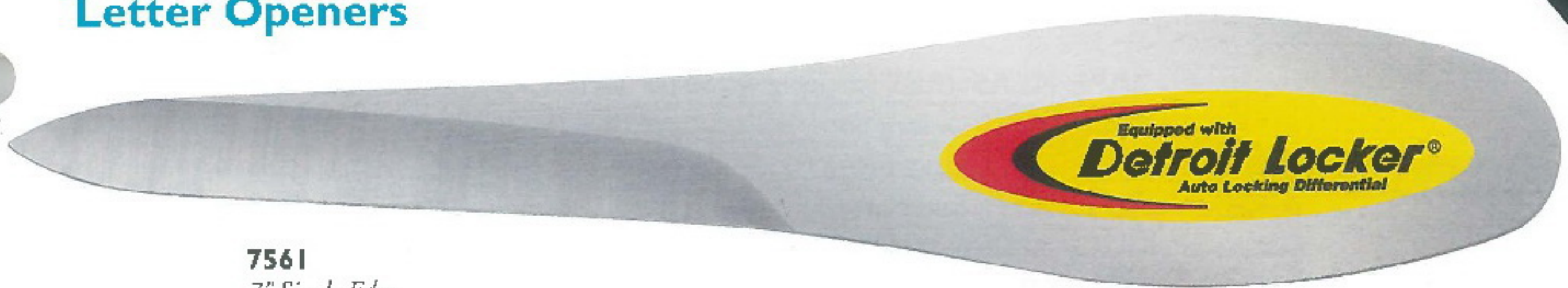

7561
7" Single Edge
Letter Opener

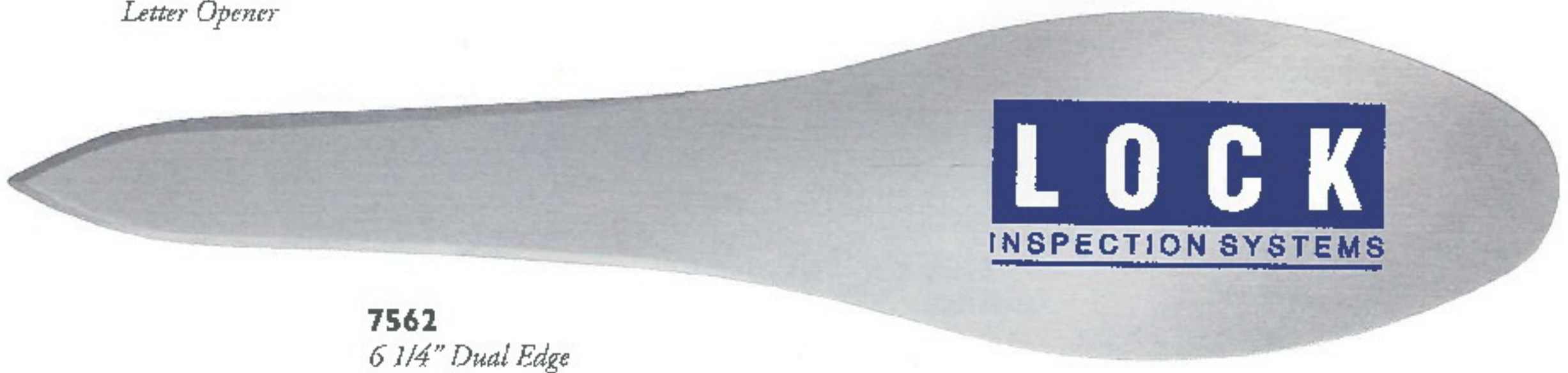

7562
6 1/4" Dual Edge
Letter Opener



Letter Opener

Standard Packaging
for Letter Openers

Money Clips



7400
Brush Stainless



7418
Black Matte

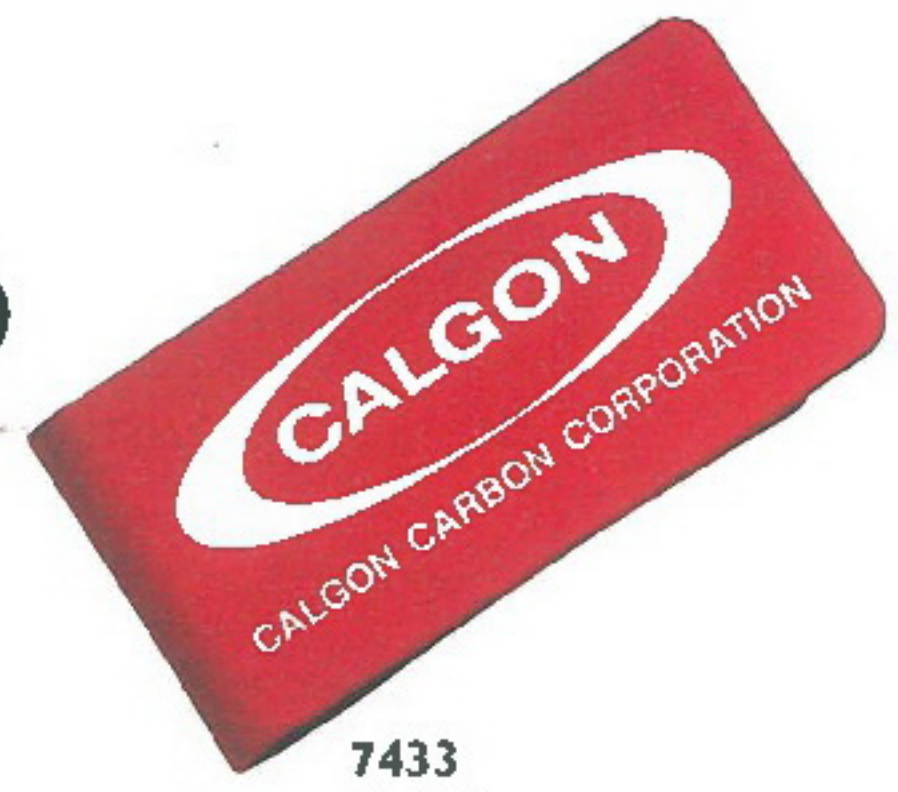

7433
Red Matte



7437
Purple Matte



Standard Packaging
for Money Clips

7439
Navy Blue Matte

7 DAY EXPRESS
All items on this page available for
7 Day Express. See Page 3 for details.

Tape Measures

Tape Measures

- Promote your brand
- Announce sales meetings
- Encourage quality control
- Serve as gifts for volunteers
- Utilize promotional themes for tie-ins:
 - See how (your company) measures up
 - Give your message a measure of exposure

Features

- Convenient pocket-size measuring device
- Combination inch-metric scale
- Easy to read white face
- 78" (200 cm) retractable steel blade
- 1 1/2" square solid brass case
- Lightweight design: 1.5 oz.
- Tightly wound, strong recoil spool
- Perfect for pocket, purse, home, or office
- Individual gift box
- Made in U.S.A. 

TAPE MEASURES (shipping wt. 50 per carton: 9 lbs.)

Model	Description	50	100	250	500	1000
6218	Black Matte	10.30	9.89	9.45	9.27	9.10
6233	Red Matte	10.30	9.89	9.45	9.27	9.10
6237	Purple Matte	10.30	9.89	9.45	9.27	9.10
6239	Navy Blue Matte	10.30	9.89	9.45	9.27	9.10
6260	Brush Chrome	8.96	8.55	8.11	7.93	7.76
6260B	Brush Brass	10.30	9.89	9.45	9.27	9.10
6260G	Brush Gold	12.30	11.89	11.45	11.27	11.10
6560	High Polish Chrome	10.30	9.89	9.45	9.27	9.10
second surface ad copy		2.63	2.22	1.78	1.60	1.43

Imprint Area

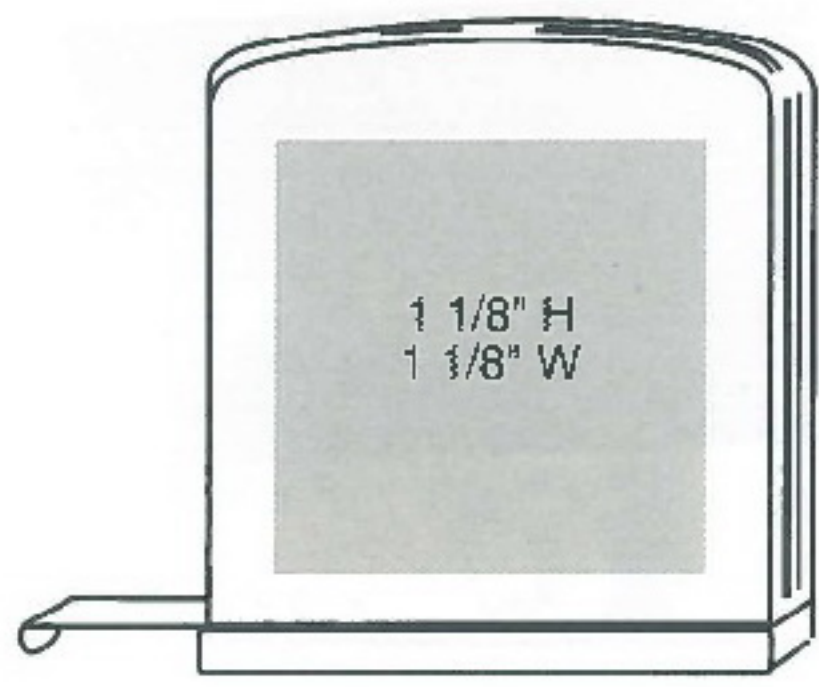

Tape Measure

Imprint Methods

	EP	SI	LE	LA	AE
Tape Measures (6200 and 6560 Series)					
Brush Chrome	X	X	X	X	X
Brush Brass		X	X	X	X
Brush Gold		X	X	X	X
All Matte Finishes		X		X	X
High Polish Chrome	X	X	X	X	X
EP = Etch and Paint	LA = Laser Engraving				
SI = Surface Imprint	AE = Computer Engraving				
LE = Lustre Etch					

Standard Packaging



6260
Brush Chrome

Blade Enlarged to Show Detail



6560
High Polish Chrome
(not shown actual size)



6218
Black Matte



6233
Red Matte

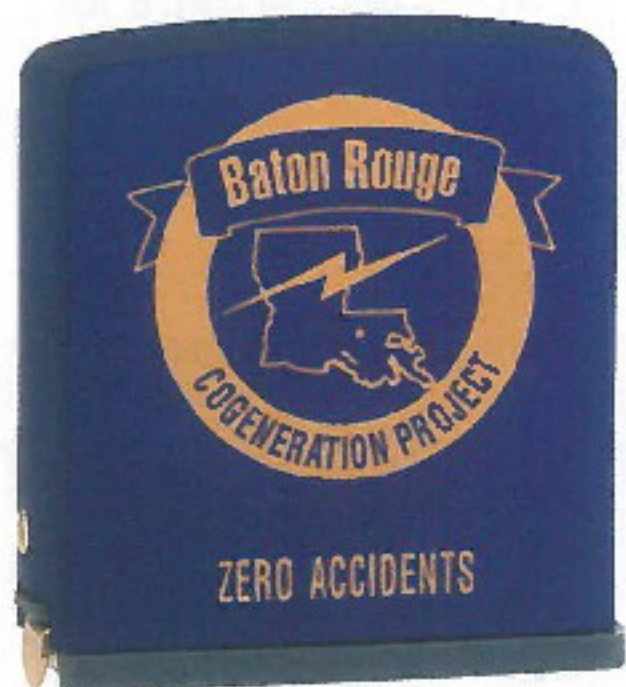

6237
Purple Matte



6239
Navy Blue Matte



6560
High Polish Chrome



6260B
Brush Brass

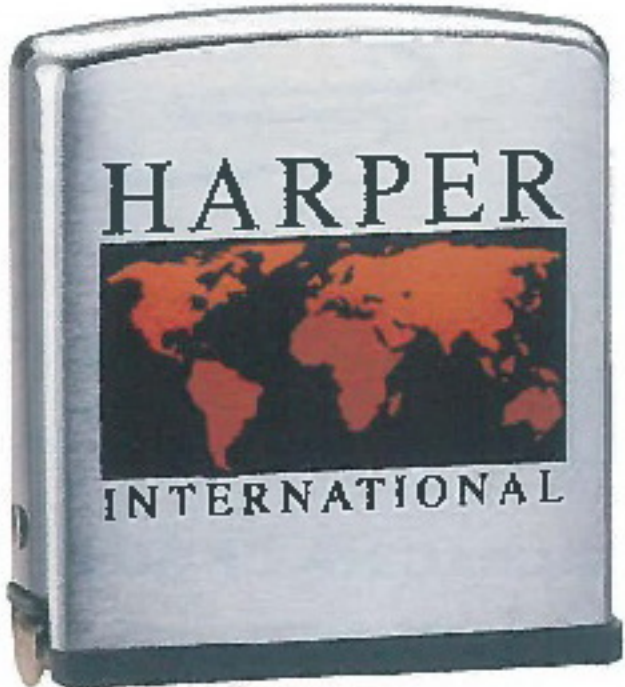

6260
Brush Chrome



6260G
Brush Gold

Greenskeeper™ Golf Tools

- Publicize special events
- Kick off member guest tournaments
- Tie in recreational themes
- Open new sales promotions
- Thank prospects
- Utilize thematic tie-ins:
 - *The drive for excellence*
 - *In the swing with . . .*

Features

- Golf spike cleaning tool
- Two handy ball markers
- Divot repair tool
- Durable, lightweight stainless steel construction
- Optional clip can attach to your bag/belt or hold money
- Individual gift box
- Made in U.S.A. 

Standard Packaging for 7900 Series



7933
Red Matte with money clip

Standard Packaging for 7700 Series



7700
Brush Stainless

GREENSKEEPER™ GOLF TOOLS

Model	Description	50	100	250	500	1000
Greenskeeper™ Golf Tools (shipping wt. 50 per carton: 6 lbs.)						
7700	Brush Stainless	9.63	9.22	8.78	8.60	8.43
7700G	Brush Gold	12.96	12.55	12.11	11.93	11.76
7718	Black Matte	10.30	9.89	9.45	9.27	9.10
7733	Red Matte	10.30	9.89	9.45	9.27	9.10
7737	Purple Matte	10.30	9.89	9.45	9.27	9.10
7739	Navy Blue Matte	10.30	9.89	9.45	9.27	9.10

second surface ad copy 2.63 2.22 1.78 1.60 1.43

Greenskeeper™ Golf Tools w/Money Clip

Model	Description	50	100	250	500	1000
Greenskeeper™ Golf Tools w/Money Clip (shipping wt. 50 per carton: 7 lbs.)						
7900	Brush Stainless	10.30	9.89	9.45	9.27	9.10
7900G	Brush Gold	13.63	13.22	12.78	12.60	12.43
7918	Black Matte	10.96	10.55	10.11	9.93	9.76
7933	Red Matte	10.96	10.55	10.11	9.93	9.76
7937	Purple Matte	10.96	10.55	10.11	9.93	9.76
7939	Navy Blue Matte	10.96	10.55	10.11	9.93	9.76

Greenskeeper™ Golf Tool Gift Set Packaging

(Shipping wt. 50 per carton: 6 lbs.) without balls

GGS Gift Set Packaging 1.90 each, any quantity

Exception

No imprint or personalization available on reverse side of 7900 series.

Imprint Methods

	EP	SI	LE	LA	AE
Greenskeeper™ Golf Tools (7700 and 7900 Series)					
Brush Stainless	X	X	X	X	X
Brush Gold		X	X	X	X
All Matte Finishes		X		X	X
EP = Etch and Paint	LA = Laser Engraving				
SI = Surface Imprint	AE = Computer Engraving				
LE = Lustre Etch					

Imprint Area

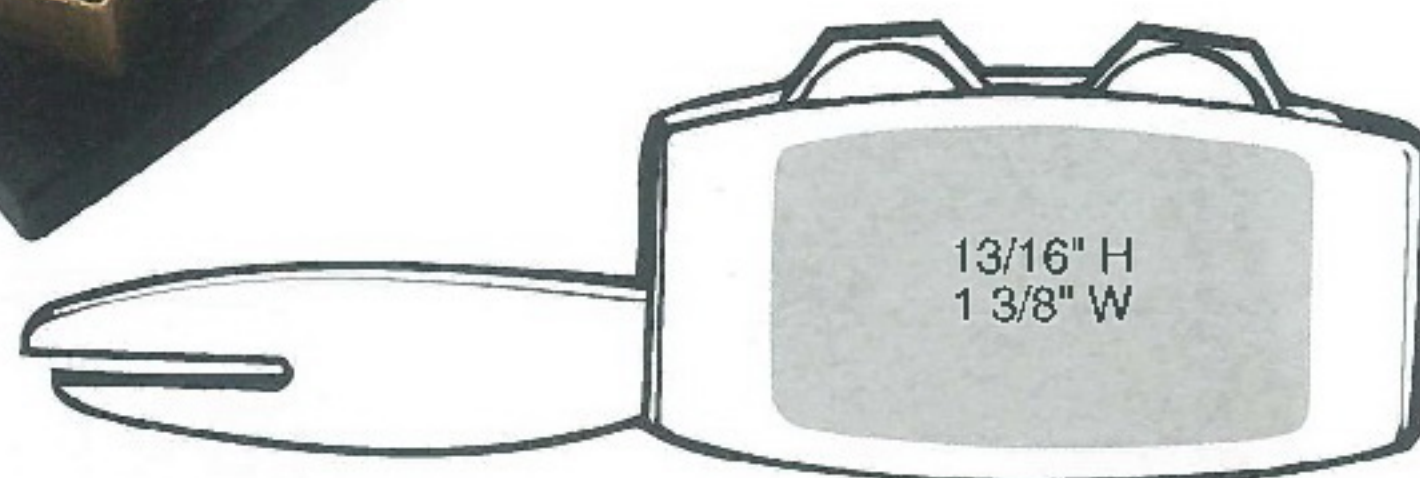

Greenskeeper™ Golf Tool
(front and reverse)
Greenskeeper™ Golf Tool w/Money Clip
(front)

SPECIAL PACKAGING OPTION

GGS
Greenskeeper™ Golf Tool
Gift Set Packaging
(Zippo does not provide golf balls)





7700
Brush Stainless

7900
Brush Stainless
with money clip



7700G
Brush Gold

7900G
Brush Gold
with money clip

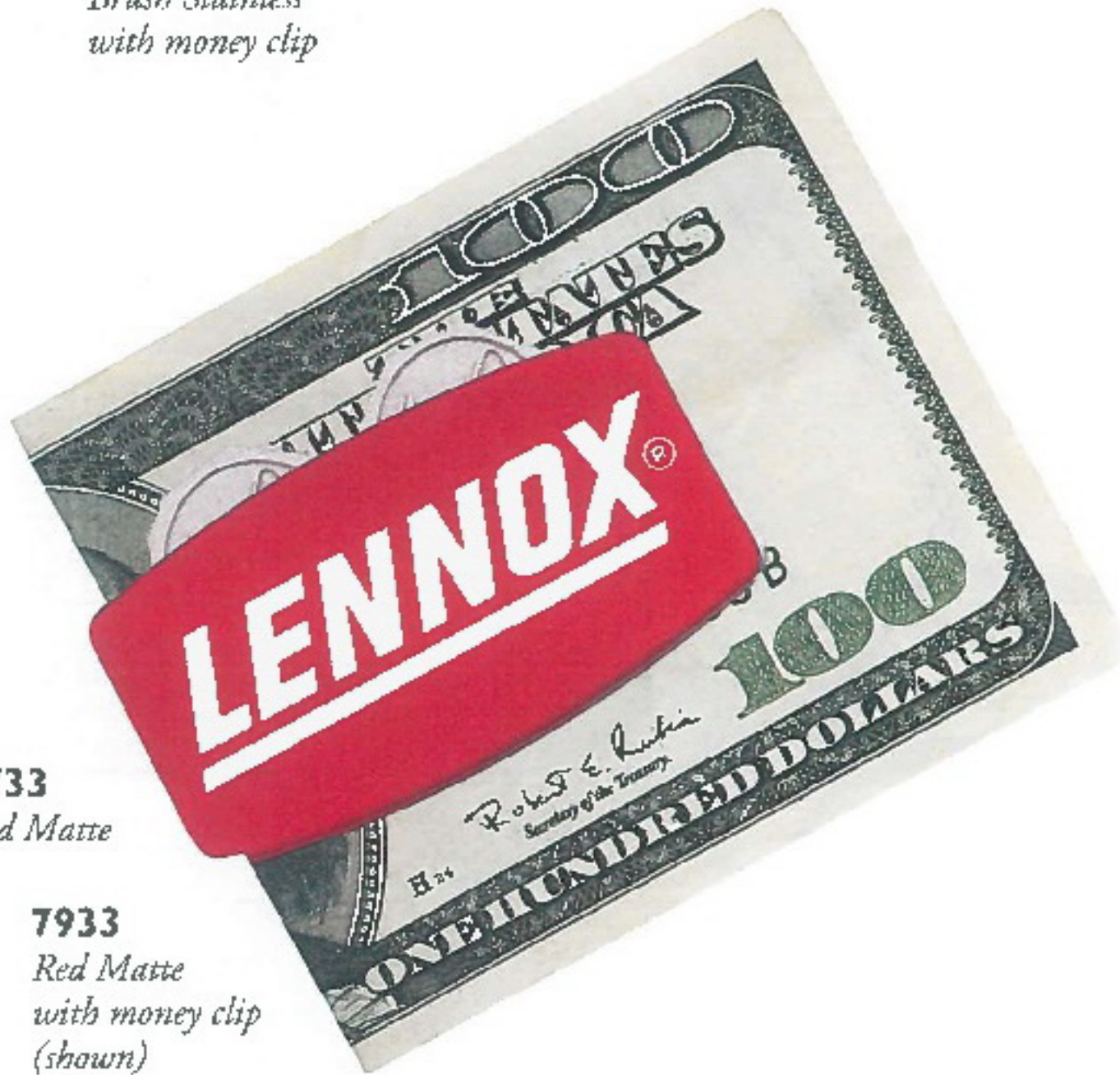

7733
Red Matte

7933
Red Matte
with money clip
(shown)



7718
Black Matte

7918
Black Matte
with money clip



7737
Purple Matte

7937
Purple Matte
with money clip



7739
Navy Blue Matte

7939
Navy Blue Matte
with money clip

Key Rings

- Announce new toll-free phone or fax service
- Serve as premiums for redemption programs
- Leave a lasting impression
- Use thematic tie-ins:
 - *We have the key to get you started*
 - *The key to our success*
 - *Unlock your potential*

Features

- 1" split ring
- Oval or rectangular shape
- Solid brass construction
- Individual gift box
- Made in U.S.A. 

KEY RINGS

Model	Description	50	100	250	500	1000
Oval (shipping wt. 50 per carton: 3 lbs.)						
5400	Brush Chrome	4.60	4.19	3.75	3.57	3.40
5400G	Brush Gold	7.93	7.52	7.08	6.90	6.73
5418	Black Matte	5.26	4.85	4.41	4.23	4.06
5433	Red Matte	5.26	4.85	4.41	4.23	4.06
5437	Purple Matte	5.26	4.85	4.41	4.23	4.06
5439	Navy Blue Matte	5.26	4.85	4.41	4.23	4.06
second surface ad copy		2.63	2.22	1.78	1.60	1.43
Rectangle (shipping wt. 50 per carton: 3 lbs.)						
5600	Brush Chrome	4.60	4.19	3.75	3.57	3.40
5600G	Brush Gold	7.93	7.52	7.08	6.90	6.73
5618	Black Matte	5.26	4.85	4.41	4.23	4.06
5633	Red Matte	5.26	4.85	4.41	4.23	4.06
5637	Purple Matte	5.26	4.85	4.41	4.23	4.06
5639	Navy Blue Matte	5.26	4.85	4.41	4.23	4.06
second surface ad copy		2.63	2.22	1.78	1.60	1.43

Imprint Methods

	EP	SI	LE	LA	AE
Key Rings (Oval and Rectangle) (5400 and 5600 Series)					
Brush Chrome		X	X	X	X
Brush Gold		X	X	X	X
All Matte Finishes				X	X
EP = Etch and Paint	SI = Surface Imprint		LE = Lustre Etch		LA = Laser Engraving
					AE = Computer Engraving

Imprint Areas

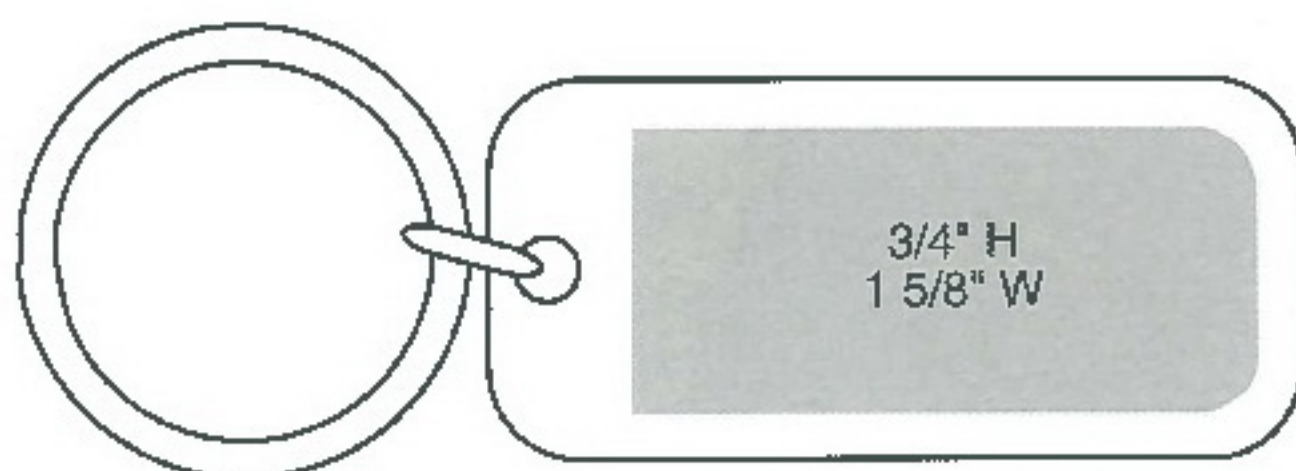

Key Ring Rectangle

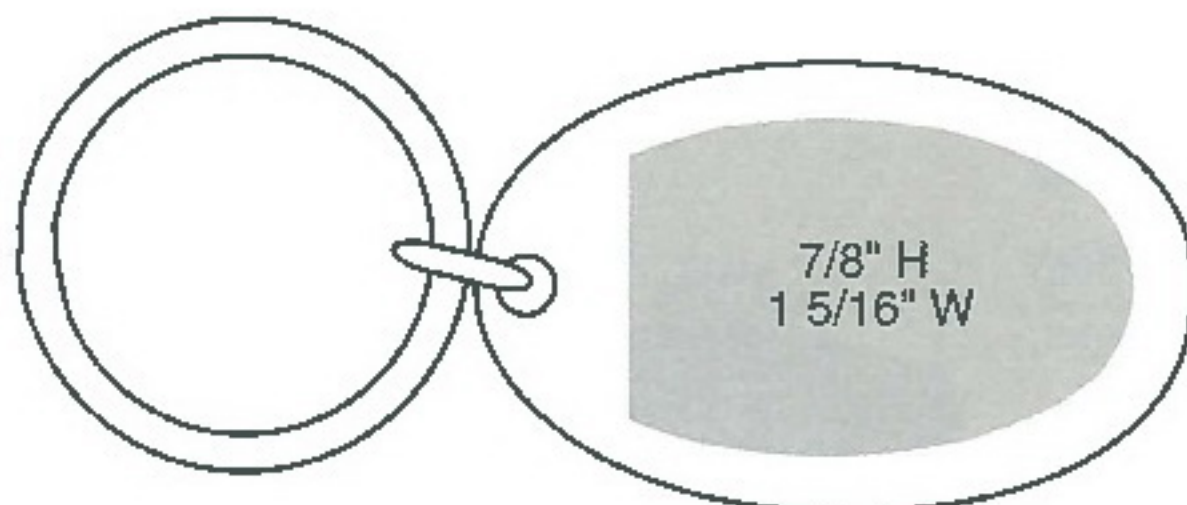

Key Ring Oval

Standard
Packaging



5600
Brush Chrome

Oval



5400
Brush Chrome

5400G
Brush Gold

5418
Black Matte

5433
Red Matte

5437
Purple Matte

5439
Navy Blue Matte

Rectangle



5600
Brush Chrome

5600G
Brush Gold

5618
Black Matte

5633
Red Matte

5637
Purple Matte

5639
Navy Blue Matte

Key Holders & Belt Buckle

Key Holders and Belt Buckle

- Recognize valued customers
- Enhance entertainment events
- Draw attention to programs
- Generate interest with tie-ins:
 - *We've buckled down for fast delivery*
 - *Congratulations to a key employee*
 - *Buckle up for safety*

Key Holder Features

- Solid brass pull-apart design
- Two sturdy, spring action steel clips hold up to five keys each
- Individual gift box
- Made in U.S.A. 

Belt Buckle Features

- Solid brass and finished in high polish chrome
- Optional tightly woven belt in two colors . . . wears forever
- One size fits most
- Practical gift for golfers, outdoorsmen, members of teams, unions or fraternal organizations
- Perfect accessory for uniforms, blue jeans or golf slacks
- Individual gift box
- Made in U.S.A. 

KEY HOLDERS & BELT BUCKLE

Model	Description	50	100	250	500	1000
Key Holders (shipping wt. 50 per carton: 5 lbs.)						
5918	Black Matte	6.60	6.19	5.75	5.57	5.40
5933	Red Matte	6.60	6.19	5.75	5.57	5.40
5937	Purple Matte	6.60	6.19	5.75	5.57	5.40
5939	Navy Blue Matte	6.60	6.19	5.75	5.57	5.40
5990	Brush Chrome	5.93	5.52	5.08	4.90	4.73
5990B	Brush Brass	6.60	6.19	5.75	5.57	5.40
5990G	Brush Gold	9.26	8.85	8.41	8.23	8.06
second surface ad copy		2.63	2.22	1.78	1.60	1.43
Belt Buckle (shipping wt. 50 per carton: 6 lbs. 4 oz.) not available in 7 Day Express						
5950	High Polish Chrome	10.96	10.55	10.11	9.93	9.76
Belt Buckle w/ Belts (shipping wt. 50 per carton: 19 lbs.)						
5955	High Polish Chrome with belt	13.63	13.22	12.78	12.60	12.43
Belt Colors: Black or Navy						

Imprint Methods

	EP	SI	LE	LA	AE
Key Holders (5900 Series)					
Brush Chrome	X	X	X	X	X
Brush Brass		X	X	X	X
Brush Gold		X	X	X	X
All Matte Finishes		X		X	X
Belt Buckle (5950 Series)					
High Polish Chrome		X		X	
EP = Etch and Paint		LA = Laser Engraving			
SI = Surface Imprint		AE = Computer Engraving			
LE = Lustre Etch					

Imprint Area

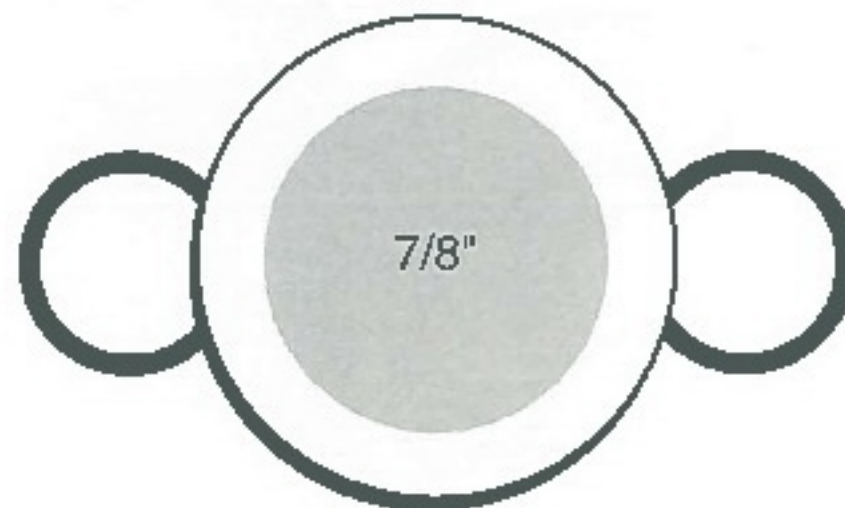

Pull-Apart Key Holder

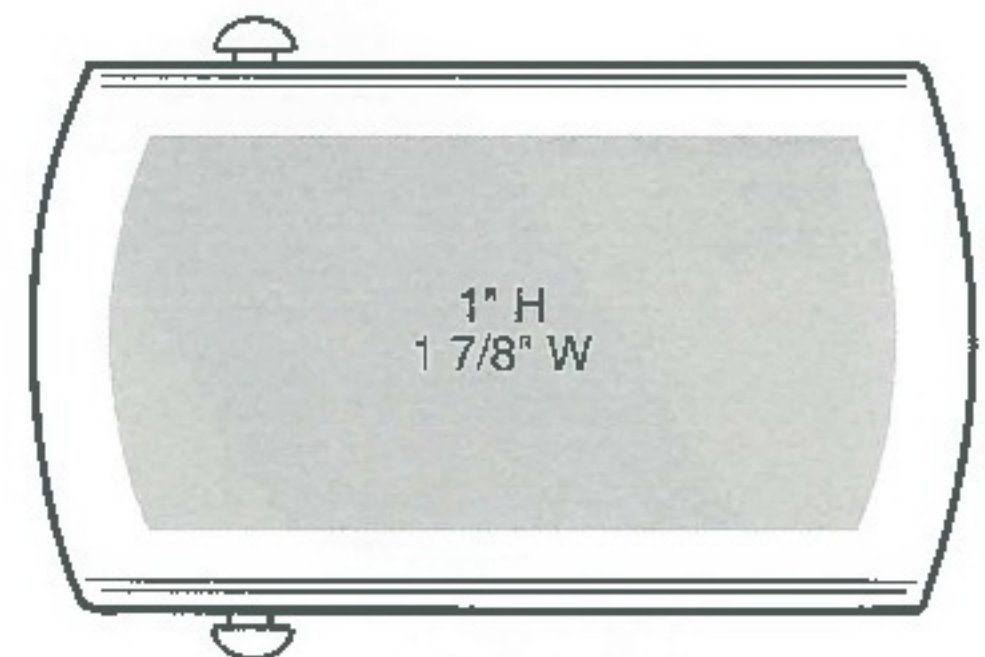

Belt Buckle



Standard Packaging
for Belt Buckle

Standard
Packaging for
Key Holders

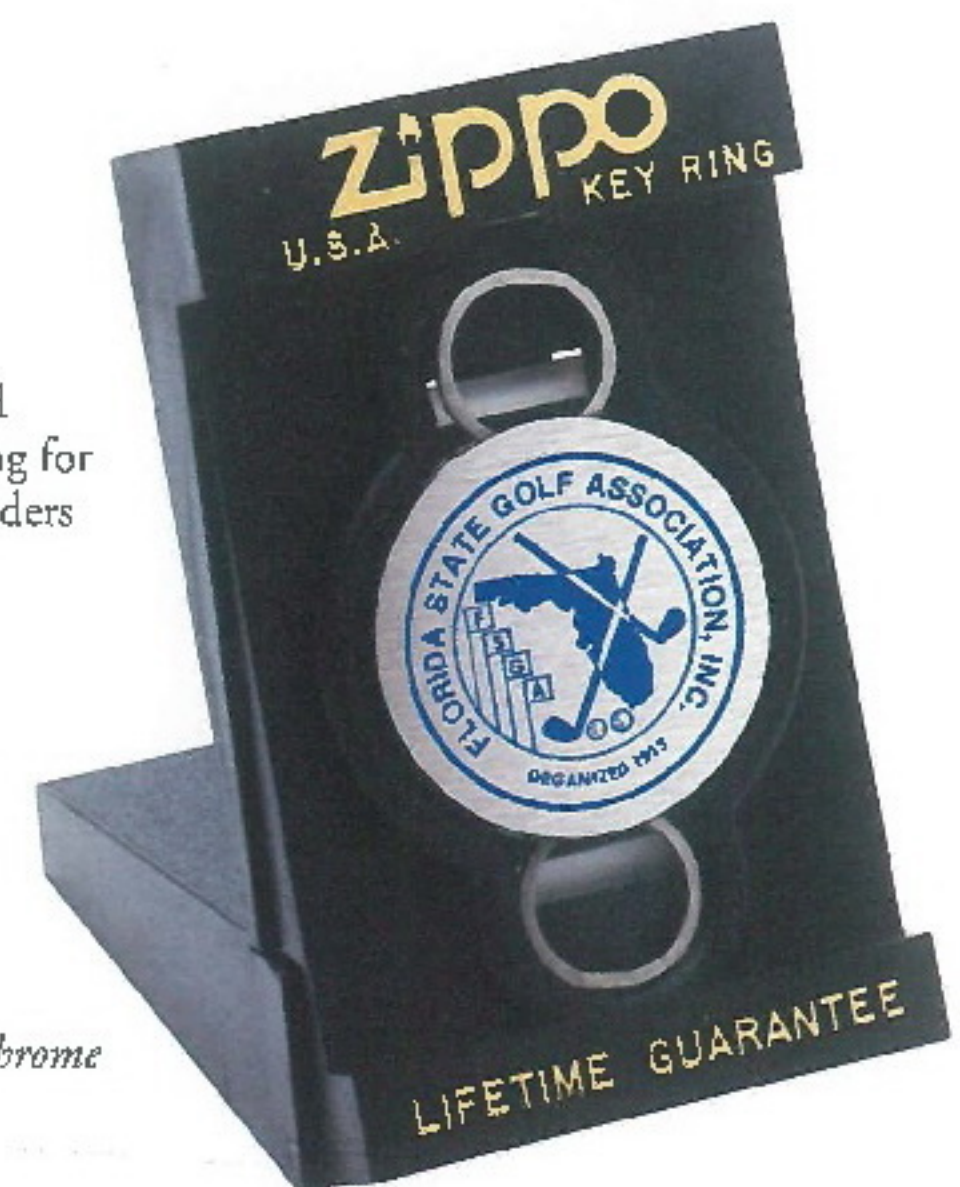

5990
Brush Chrome

LIFETIME GUARANTEE

Key Holders



5918
Black Matte



5933
Red Matte



5937
Purple Matte



5990B
Brush Brass



5939
Navy Blue Matte



5990G
Brush Gold



5990
Brush Chrome

7 DAY EXPRESS
Key Holders on this page available for 7 Day Express. See Page 3 for details.

Belt Buckle (not available in 7 Day Express Program)



5950
High Polish Chrome



5955
High Polish Chrome with belt

Material: Polypropylene
Belt Colors: Navy or Black

Standard Packaging for Gift Set



Windproof Lighters

- Tie-in gold or silver themes
- Show appreciation
- Portable, affordable, memorable
- Symbolize achievement
- A great way to light someone's fire or thank them for putting one out
- Promote company pride
- Target sales messages with tie-ins:
 - *Lighting the way to profits*
 - *Bright ideas come from . . .*
 - *Fire-up your sales*

Features

- Classic design
- Highly collectible
- Stainless steel insert
- Solid brass case construction
- Specially designed windproof chimney
- Sturdy nickel silver hinge
- Individual gift box
- Worldwide brand recognition
- Made in U.S.A. 

Standard Packaging

254B
High Polish Brass



WINDPROOF LIGHTERS (shipping wt. 50 per carton: 9 lbs.)

Model	Description	50	100	250	500	1000+
15	Sterling Silver	107.95	107.77	107.60	107.44	107.24
200	Brush Chrome	11.93	11.75	11.58	11.42	11.22
200ZG	Brush Chrome w/Zip Guard	15.27	15.09	14.92	14.76	14.56
204B	Brush Brass	14.60	14.42	14.25	14.09	13.89
205	Satin Chrome	11.27	11.09	10.92	10.76	10.56
207	Street Chrome	11.27	11.09	10.92	10.76	10.56
207G	Gold Dust	13.93	13.75	13.58	13.42	13.22
250	High Polish Chrome	13.93	13.75	13.58	13.42	13.22
250G	High Polish Gold	18.60	18.42	18.25	18.09	17.89
254B	High Polish Brass	15.27	15.09	14.92	14.76	14.56
275	Brush Chrome Loss Proof	13.93	13.75	13.58	13.42	13.22
each additional surface ad copy		2.63	2.45	2.28	2.12	1.92

Imprint Methods

	EP	SI	LE	LA	AE
Windproof Lighters (200 Series)					
Brush Chrome	X	X	X	X	X
Satin Chrome		X	X	X	X
Street Chrome		X	X	X	X
High Polish Chrome	X	X	X	X	X
Brush Brass		X	X	X	X
High Polish Brass		X	X	X	X
Sterling Silver					X
Gold Dust		X	X	X	X
High Polish Gold		X	X	X	X
EP = Etch and Paint		LA = Laser Engraving			
SI = Surface Imprint		AE = Computer Engraving			
LE = Lustre Etch					

Exceptions

We will waive the less-than-minimum charge on an order of 25 lighters if any other Zippo product in this catalog is ordered in minimum quantity at the same time.

Surfaces 5 thru 9 can only be laser engraved.

Model #15 Sterling Silver is available with computer engraving process only. Sterling

Imprint Areas

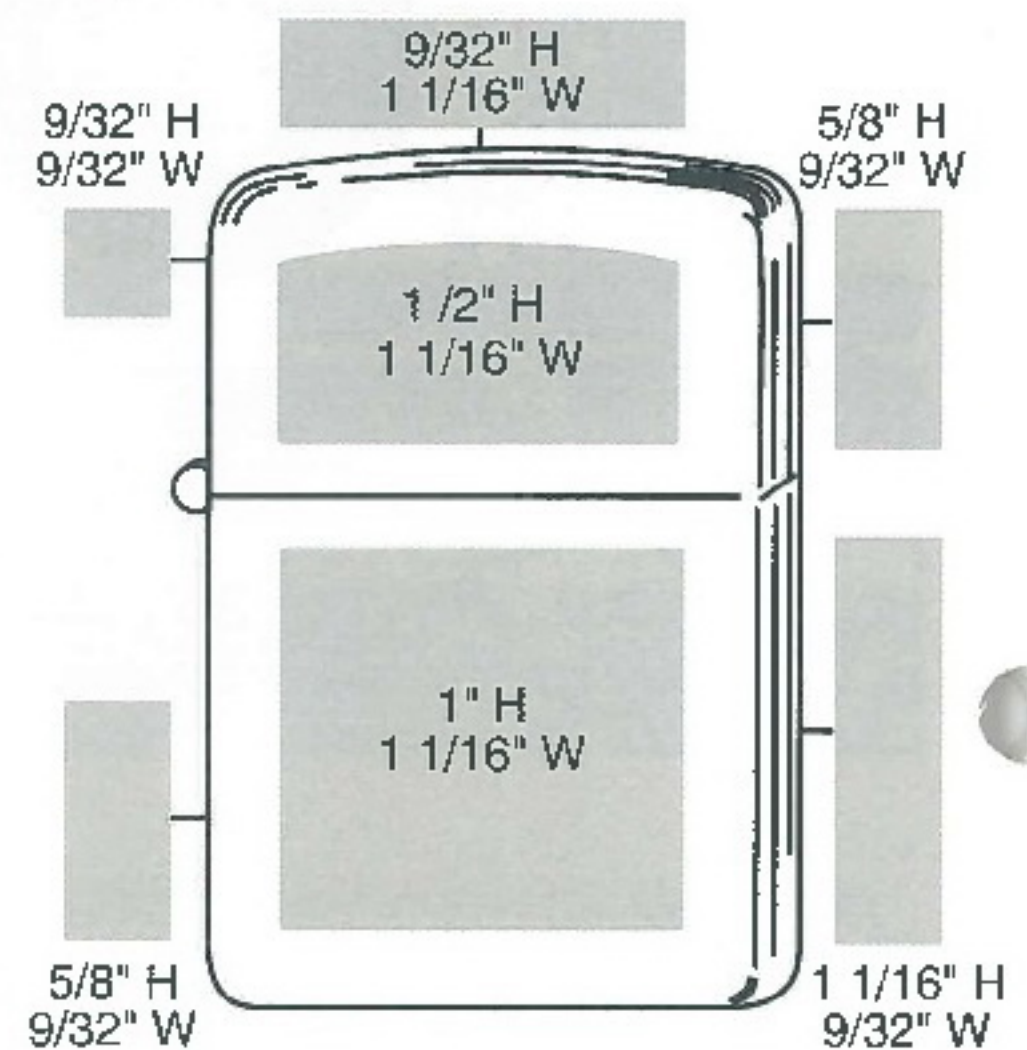

Regular Lighter

Silver finish is available in a minimum quantity of 25 units. Speculative samples and pre-production samples are not available on Sterling Silver. Not available in 7 Day Express program.

There are nine imprint surfaces on a windproof lighter as shown here

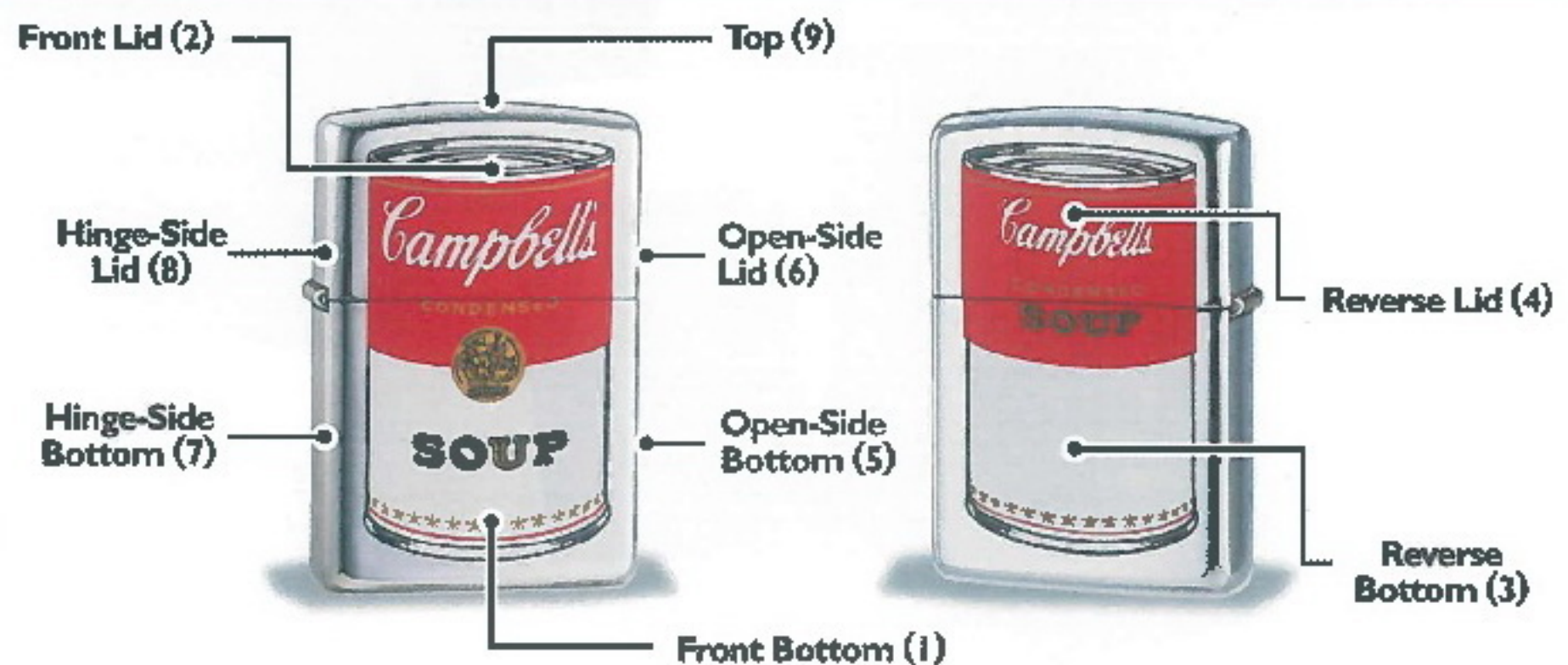



15
Sterling Silver
(computer engrave
imprint shown)



200
Brush Chrome



200ZG
Zip Guard
Brush Chrome
(lustre etch imprint shown)



200YZG
Yellow Zip
Guard
Brush Chrome



200BZG
Blue Zip Guard
Brush Chrome



200RZG
Red Zip Guard
Brush Chrome

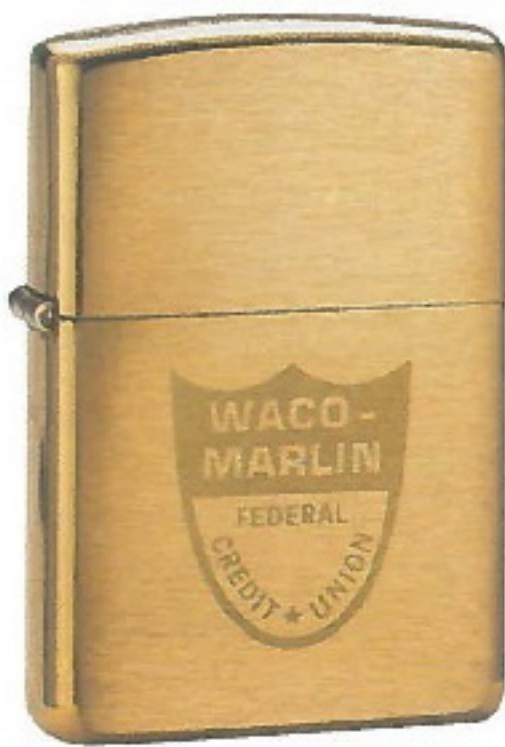

204B
Brush Brass
(laser imprint shown)



205
Satin Chrome



207
Street Chrome



207G
Gold Dust



250
High Polish Chrome



250G
High Polish Gold



275
Brush Chrome
Loss Proof



Of special interest to collectors: The authenticity of your Zippo windproof lighter is assured by the factory stamp on the bottom of the case. The code indicates month and year of manufacture. Call Zippo for a free Zippo Lighter Collectors Guide. zippo.com

7 DAY EXPRESS

All items on this page except model #15 Sterling Silver available for 7 Day Express. See Page 3 for details.

Windproof Lighters

Windproof Lighters

- Employee rewards at your fingertips
- Say thanks with a gift for the great outdoors
- Reward peak efficiency
- Target sales messages with tie-ins:
 - *Fire-up your interests*
 - *Ideas that click*
 - *Satisfaction guaranteed*

Features

- *Classic design*
- *Highly collectible*
- *Stainless steel insert*
- *Solid brass case construction*
- *Specially designed windproof chimney*
- *Sturdy nickel silver hinge*
- *Individual gift box*
- *Worldwide brand recognition*
- *Made in U.S.A.* 

WINDPROOF LIGHTERS (shipping wt. 50 per carton: 9 lbs.)

Model	Description	50	100	250	500	1000+
150	Black Ice	15.93	15.75	15.58	15.42	15.22
212	Sand Matte	13.93	13.75	13.58	13.42	13.22
215	Teal Matte	13.93	13.75	13.58	13.42	13.22
216	Cream Matte	13.93	13.75	13.58	13.42	13.22
218	Black Matte	13.93	13.75	13.58	13.42	13.22
229	Royal Blue Matte	13.93	13.75	13.58	13.42	13.22
231	Orange Matte	13.93	13.75	13.58	13.42	13.22
233	Red Matte	13.93	13.75	13.58	13.42	13.22
236	Black Crackle	13.93	13.75	13.58	13.42	13.22
237	Purple Matte	13.93	13.75	13.58	13.42	13.22
239	Navy Blue Matte	13.93	13.75	13.58	13.42	13.22
451	Realtree Hardwoods®	15.93	15.75	15.58	15.42	15.22
each additional surface ad copy		2.63	2.45	2.28	2.12	1.92

Exceptions

We will waive the less-than-minimum charge on an order of 25 lighters if any other Zippo product in this catalog is ordered in minimum quantity at the same time.

Surfaces 5 thru 9 (see diagram on page 23) can only be laser engraved.

Model #236 Black Crackle is available with laser engraving only.

No personalization available on model #451 REALTREE HARDWOODS®.

Imprint Methods

	EP	SI	LE	LA	AE
Windproof Lighters (150, 200 and 400 Series)					
All Matte Finishes		X		X	X
Black Crackle				X	
Black Ice		X		X	X
Realtree Hardwoods®		X		X	
EP = Etch and Paint	SI = Surface Imprint		LE = Lustre Etch		LA = Laser Engraving
					AE = Computer Engraving

Imprint Areas

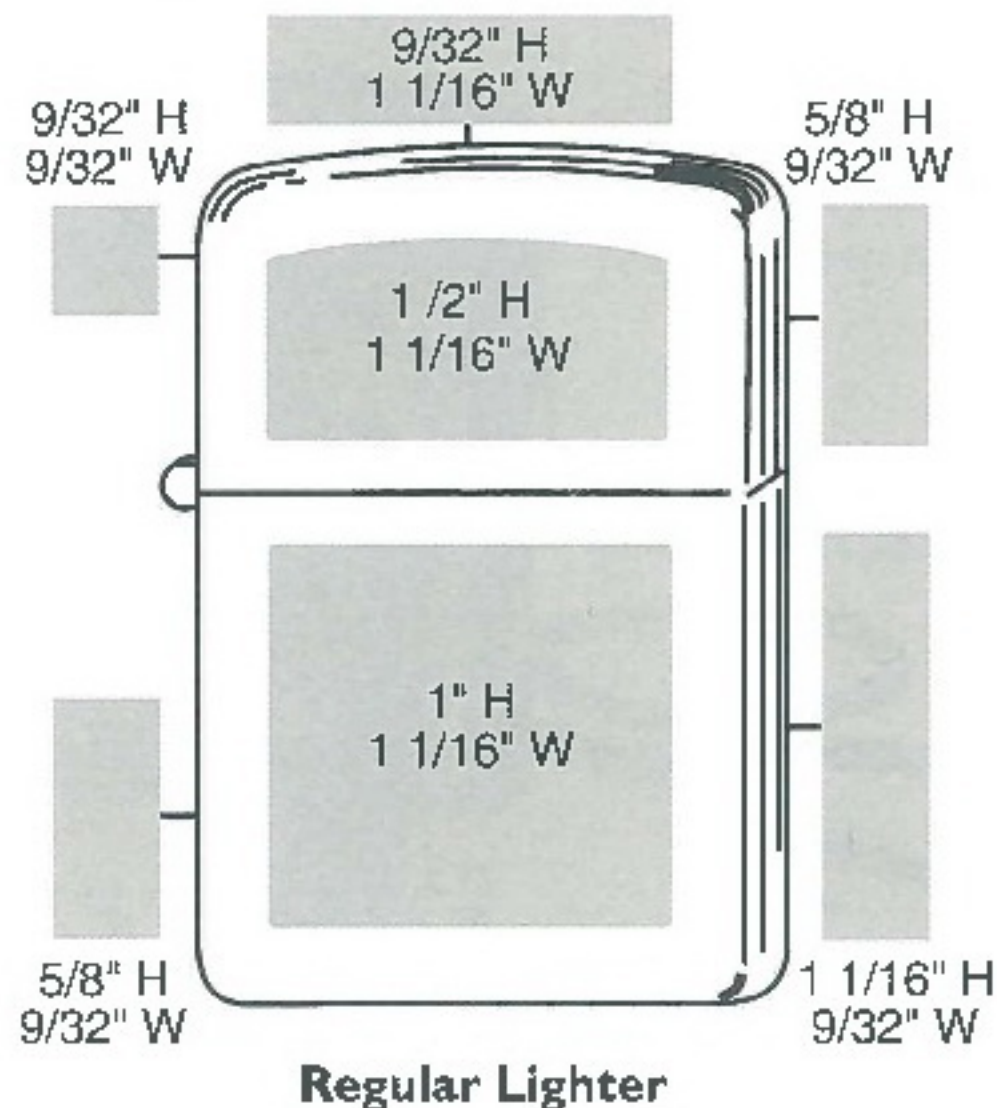

Standard Packaging



233
Red Matte



150
Black Ice



212
Sand Matte



215
Teal Matte



216
Cream Matte



218
Black Matte



229
Royal Blue Matte



231
Orange Matte



236
Black Crackle



237
Purple Matte



239
Navy Blue Matte



451
REALTREE HARDWOODS®
© Jordan Outdoor Enterprises, Ltd.
- 1998

Windproof Lighters

WINDPROOF LIGHTERS

Model	Description	50	100	250	500	1000+
Anodized Aluminum Series (shipping wt. 50 per carton: 10 lbs.)						
685	Red Anodized Aluminum	20.60	20.42	20.25	20.08	19.88
686	Blue Anodized Aluminum	20.60	20.42	20.25	20.08	19.88
687	Green Anodized Aluminum	20.60	20.42	20.25	20.08	19.88
688	Champagne Anodized Aluminum	20.60	20.42	20.25	20.08	19.88
each additional surface ad copy		2.63	2.45	2.28	2.12	1.92
Vintage Series (shipping wt. 50 per carton: 8 lbs. 12oz.)						
230	Brush Chrome	13.93	13.75	13.58	13.42	13.22
240	Brush Brass	15.27	15.09	14.92	14.76	14.56
260	High Polish Chrome	14.60	14.42	14.25	14.09	13.89
270	High Polish Brass	15.93	15.75	15.58	15.42	15.22
each additional surface ad copy		2.63	2.45	2.28	2.12	1.92

Windproof Lighters

- Commemorate company milestones
- Introduce new products
- Reward service
- Promote new products
- Spotlight events
- Generate interest with tie-ins:
 - *Our products will ignite sales*
 - *Your ideas burn bright with...*

Features

- Classic design
- Highly collectible
- Stainless steel insert
- Solid brass case construction
- Specially designed windproof chimney
- Sturdy nickel silver hinge
- Individual gift box
- Worldwide brand recognition
- Made in U.S.A. 

Imprint Methods

	EP	SI	LE	LA	AE
Anodized Aluminum Lighters (680 Series)					
Anodized Aluminum				X	
Vintage Lighters (230, 240, 260 and 270 Series)					
Brush Chrome		X	X	X	X
Brush Brass		X	X	X	X
High Polish Chrome		X	X	X	X
High Polish Brass		X	X	X	X
EP = Etch and Paint	LA = Laser Engraving				
SI = Surface Imprint	AE = Computer Engraving				
LE = Lustre Etch					

Exception

Surfaces 5 thru 9 can only be laser engraved.

We will waive the less-than-minimum charge on an order of 25 lighters if any other Zippo product in this catalog is ordered in minimum quantity at the same time.

Imprint Areas

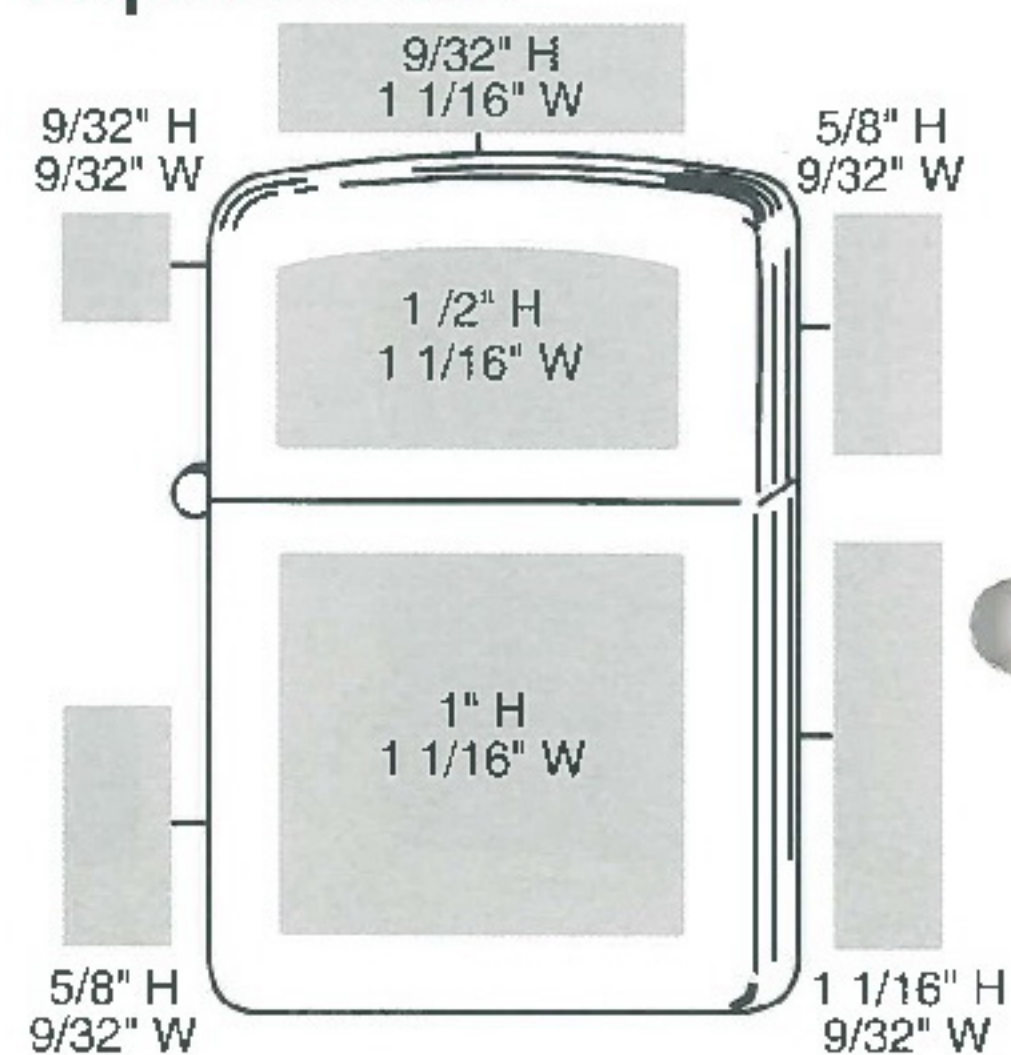

Regular Lighter

There are nine imprint surfaces on a windproof lighter as shown here

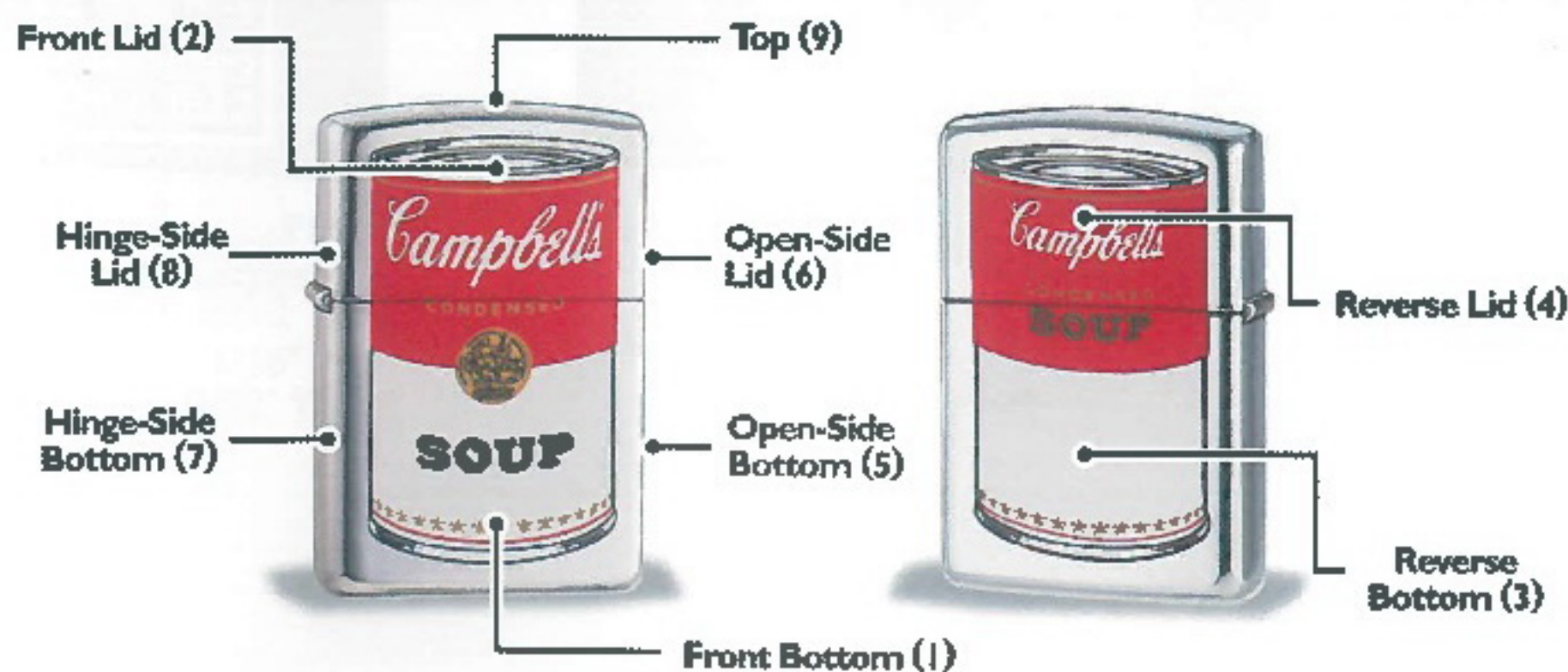

Anodized Aluminum Series Windproof Lighters



686
Blue Anodized Aluminum
(laser imprint shown)

685
Red Anodized Aluminum
(laser imprint shown)



687
Green Anodized Aluminum
(laser imprint shown)



Standard Packaging
for Anodized
Aluminum and
Vintage lighters.

688
Champagne Anodized
Aluminum
(laser imprint shown)

Vintage Series Windproof Lighters

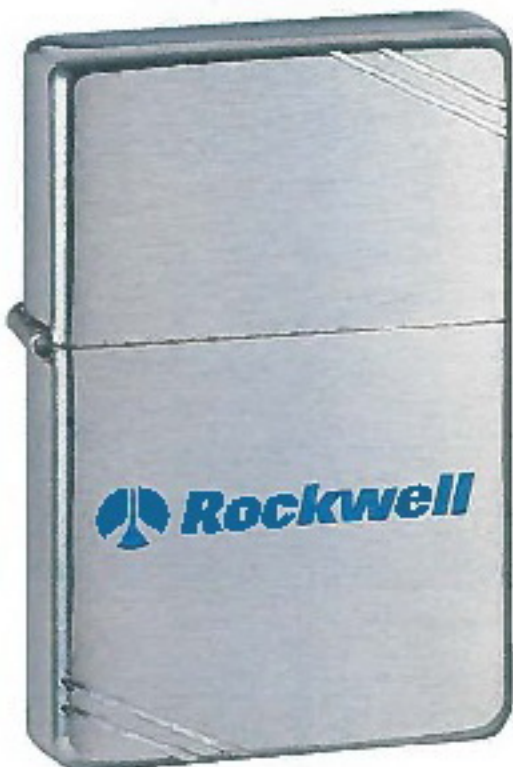

230
Brush Chrome



240
Brush Brass



260
High Polish Chrome

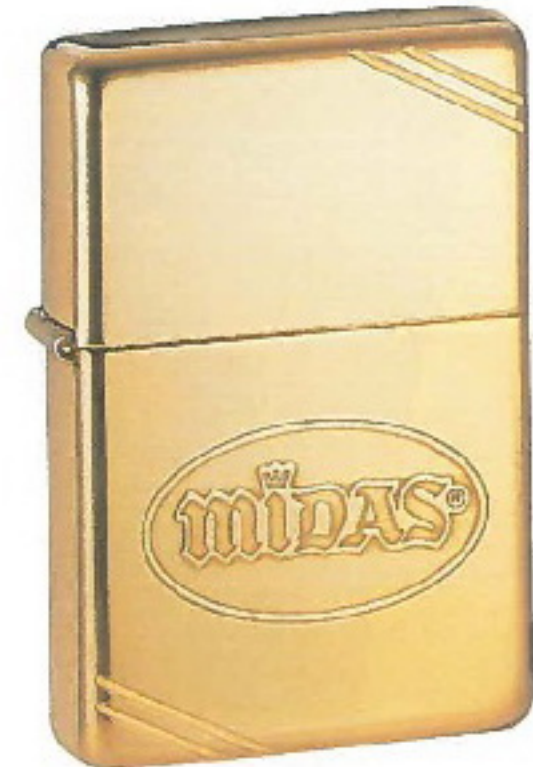

270
High Polish Brass



Of special interest to collectors: The authenticity of your Zippo windproof lighter is assured by the factory stamp on the bottom of the case. The code indicates month and year of manufacture. Call Zippo for a free Zippo Lighter Collectors Guide. zippo.com

7 DAY EXPRESS

All items on this page available for 7 Day Express. See Page 3 for details.

Windproof Lighters

WINDPROOF LIGHTERS

Model	Description	50	100	250	500	1000+
Zippo at Work Series (shipping wt. 50 per carton: 9 lbs.)						
716	Police	13.27	13.08	12.92	12.75	12.55
717	Carpenter	13.27	13.08	12.92	12.75	12.55
718	Electrician	13.27	13.08	12.92	12.75	12.55
719	Firefighter	13.27	13.08	12.92	12.75	12.55
720	EMT	13.27	13.08	12.92	12.75	12.55
721	Painter	13.27	13.08	12.92	12.75	12.55
722	Mechanic	13.27	13.08	12.92	12.75	12.55
724	Bartender	13.27	13.08	12.92	12.75	12.55
725	Welder	13.27	13.08	12.92	12.75	12.55
726	Plumber	13.27	13.08	12.92	12.75	12.55
727	Trucker	13.27	13.08	12.92	12.75	12.55
728	Nurse	13.27	13.08	12.92	12.75	12.55
each additional surface ad copy		2.63	2.45	2.28	2.12	1.92

Windproof Lighters

- A great way to light someone's fire . . . or thank them for putting one out
- Ignite company pride
- Reward peak efficiency
- Spotlight events
- Symbolize achievement
- Target sales messages with tie-ins:
 - *Fire-up your sales*
 - *Ideas that click*

Features

- *Classic design*
- *Highly collectible*
- *Stainless steel insert*
- *Solid brass case construction*
- *Specially designed windproof chimney*
- *Sturdy nickel silver hinge*
- *Individual gift box*
- *Worldwide brand recognition*
- *Made in U.S.A.* 

Exceptions

Surfaces 5 thru 9 (see diagram on page 23) can only be laser engraved.

No imprint on front bottom surface.

We will waive the less-than-minimum charge on an order of 25 lighters if any other Zippo product in this catalog is ordered in minimum quantity at the same time.

Imprint Methods

	EP	SI	LE	LA	AE
Windproof Lighters (700 Series)					
Satin Chrome		X	X	X	X
EP = Etch and Paint	LA = Laser Engraving				
SI = Surface Imprint	AE = Computer Engraving				
LE = Lustre Etch					

NEW

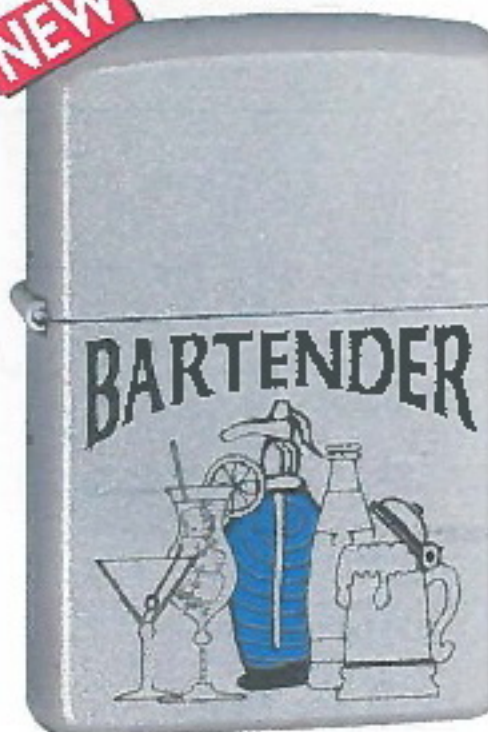

724
Bartender
Satin Chrome
with front and reverse imprint

Standard Packaging for Zippo at Work series



719
Firefighter
Satin Chrome

Imprint Areas

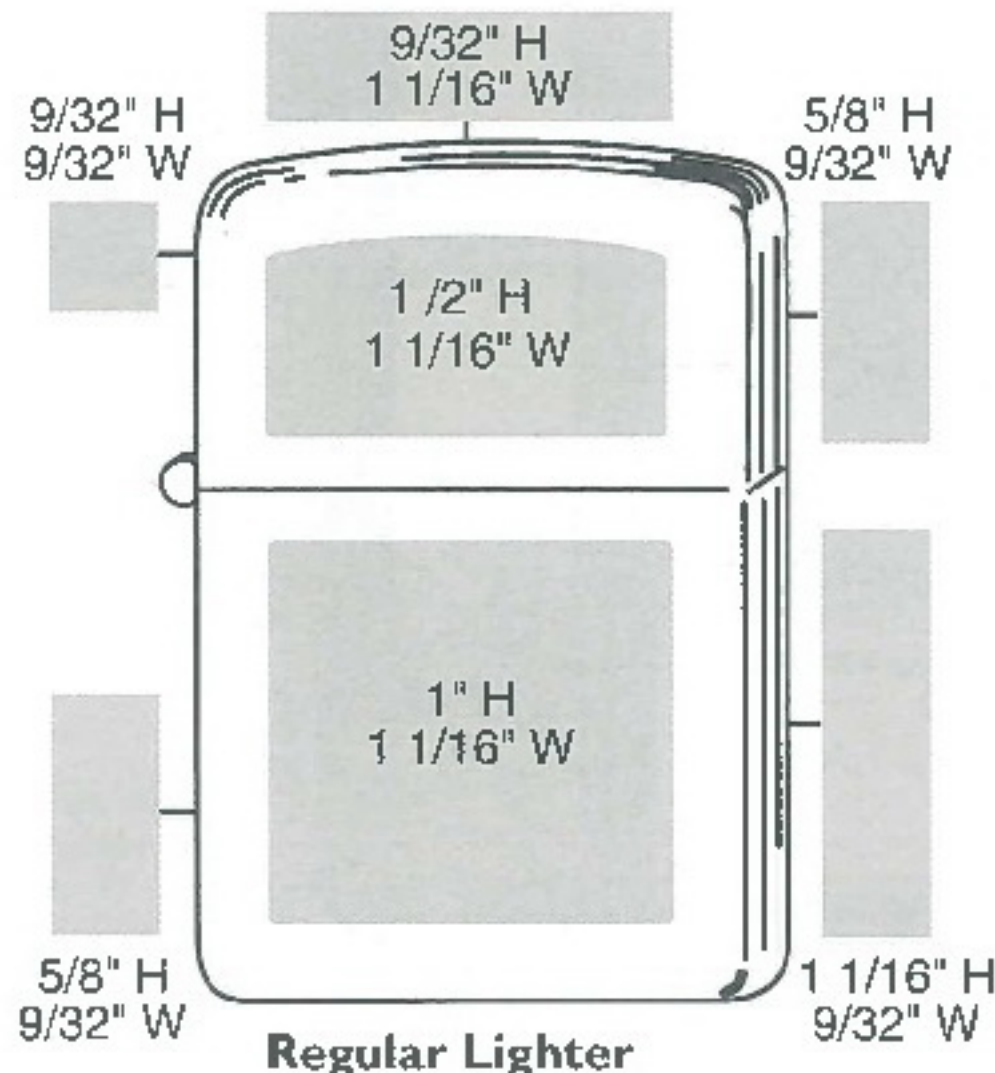

Zippos at Work Series

W
i
n
d
p
r
o
o
f
L
i
g
h
t
e
r
s

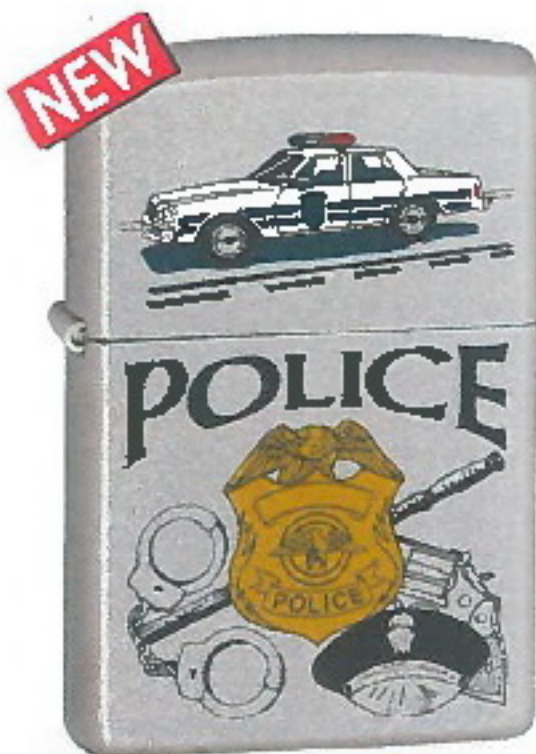

716
Police
Satin Chrome

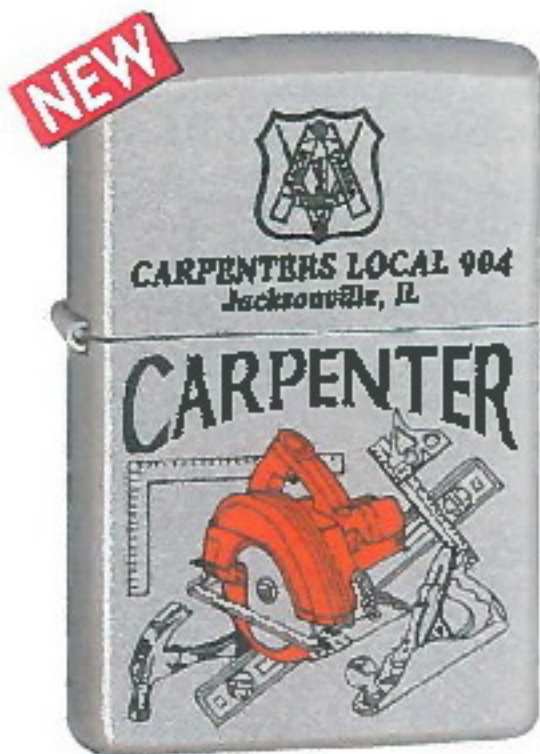

717
Carpenter
Satin Chrome



718
Electrician
Satin Chrome



720
EMT
Satin Chrome



721
Painter
Satin Chrome



722
Mechanic
Satin Chrome



724
Bartender
Satin Chrome

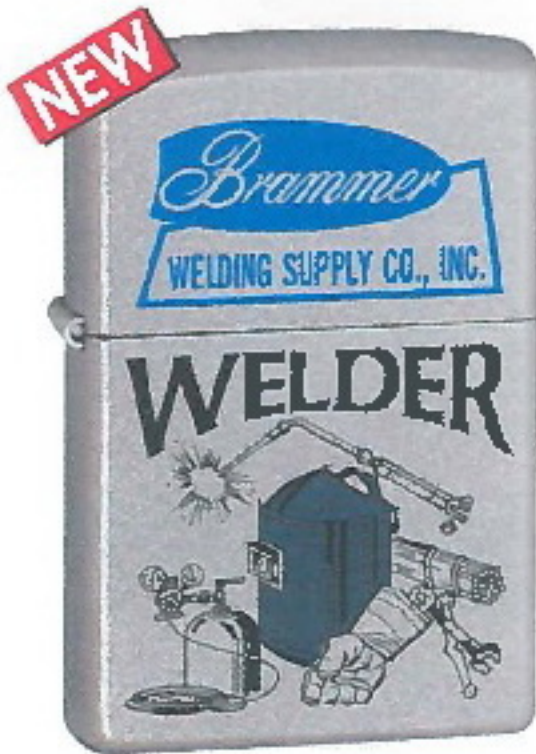

725
Welder
Satin Chrome

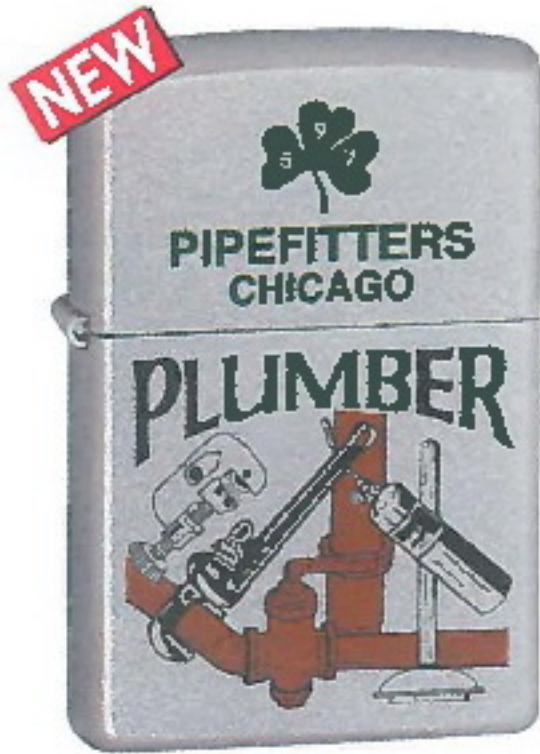

726
Plumber
Satin Chrome



727
Truck Driver
Satin Chrome

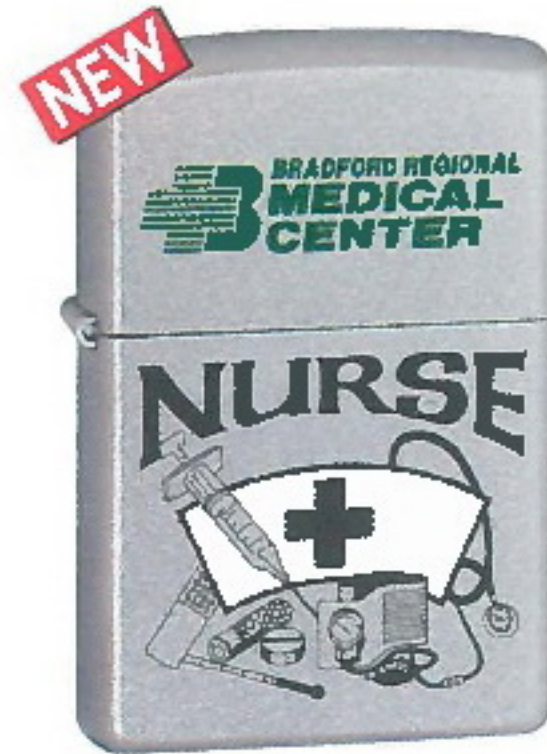

728
Nurse
Satin Chrome



Of special interest to collectors: The authenticity of your Zippo windproof lighter is assured by the factory stamp on the bottom of the case. The code indicates month and year of manufacture. Call Zippo for a free Zippo Lighter Collectors Guide. zippo.com

7 DAY EXPRESS

All items on this page available for 7 Day Express. See Page 3 for details.

Windproof Lighters

- Commemorate company milestones
- Tie-in gold or silver themes
- Say thanks with a gift for the great outdoors
- Promote new products
- Generate interest with tie-ins:
 - *Our products will ignite sales*
 - *Your ideas burn bright with . . .*

Features

- *Surprise lighters click open to reveal whimsical element*
- *Classic design*
- *Highly collectible*
- *Stainless steel insert*
- *Solid brass case construction*
- *Specially designed windproof chimney*
- *Sturdy nickel silver hinge*
- *Individual gift box*
- *Worldwide brand recognition*
- *Made in U.S.A.* 

WINDPROOF LIGHTERS

Model	Description	50	100	250	500	1000+
Surprise Series (shipping wt. 50 per carton: 12 lbs. 8 oz.)						
200BS B245	Buckle Up/Pewter Emblem	23.93	23.75	23.58	23.42	23.22
204BBS B244	Buckle Up/Brass Emblem	26.60	26.42	26.25	26.09	25.88
254BBS B151	High Polish Brass Full House	25.27	25.09	24.92	24.76	24.56
254BBS B164	High Polish Brass Martini	25.27	25.09	24.92	24.76	24.56
207BS B228	Bowling	23.93	23.75	23.58	23.42	23.22
207BS B229	Bingo	23.93	23.75	23.58	23.42	23.22
207BS B230	Lucky 7	23.93	23.75	23.58	23.42	23.22
207BS B231	Jackpot	23.93	23.75	23.58	23.42	23.22
each additional surface ad copy		2.63	2.45	2.28	2.12	1.92

Exceptions

Surfaces 5 thru 9 can only be laser engraved.

We will waive the less-than-minimum charge on an order of 25 lighters if any other Zippo product in this catalog is ordered in minimum quantity at the same time.

Imprint Methods

	EP	SI	LE	LA	AE
Windproof Lighters (200 Series)					
Brush Chrome	X	X	X	X	X
Street Chrome		X	X	X	X
Brush Brass		X	X	X	X
High Polish Brass		X	X	X	X
EP = Etch and Paint		LA = Laser Engraving			
SI = Surface Imprint		AE = Computer Engraving			
LE = Lustre Etch					

Imprint Areas

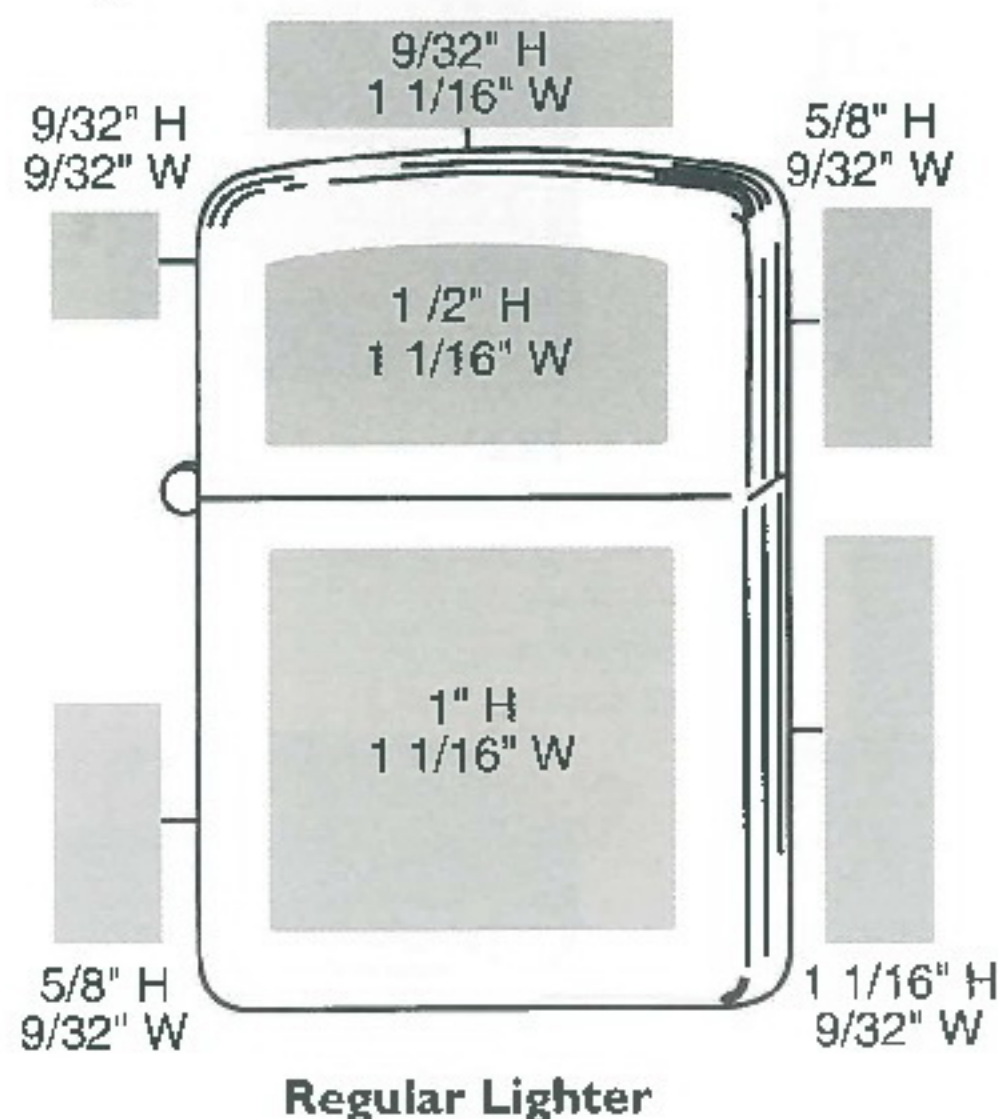

Standard Packaging for Surprise Series



There are nine imprint surfaces on a windproof lighter as shown here

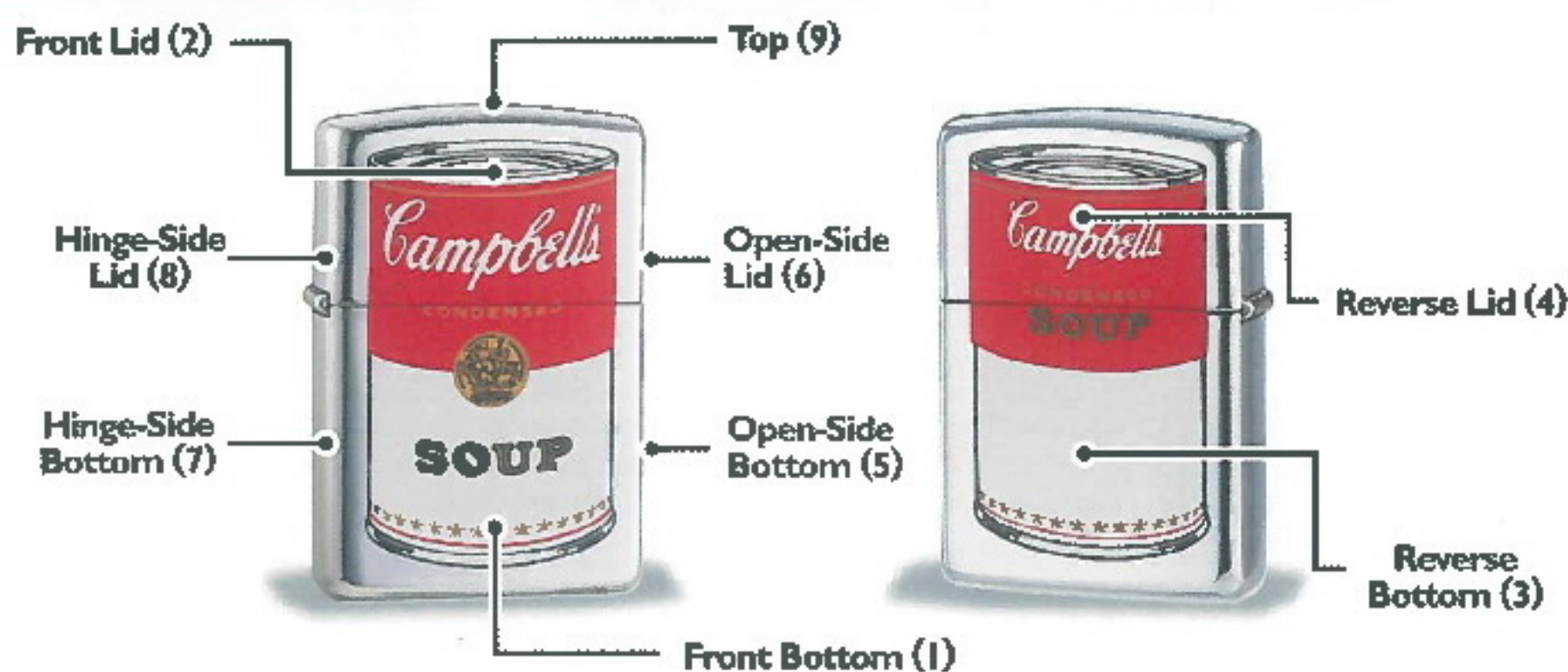

Surprise Series Windproof Lighters (standard packaging Zippo tin)

Reverse lid or bottom can be custom imprinted -
no imprinting available on front surface of surprise lighters.



200BS B245
Buckle Up Pewter - Brush Chrome



254BBS B164
Martini - High Polish Brass

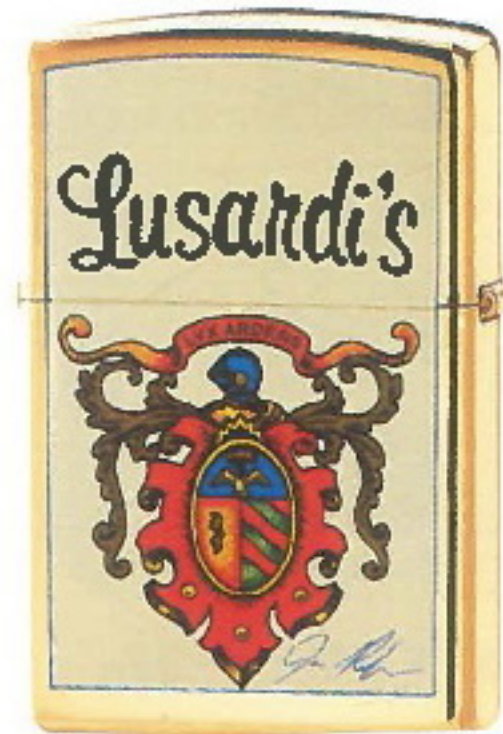

204BBS B244
Buckle Up Brass - Brush Brass



254BBS B151
Full House - High Polish Brass

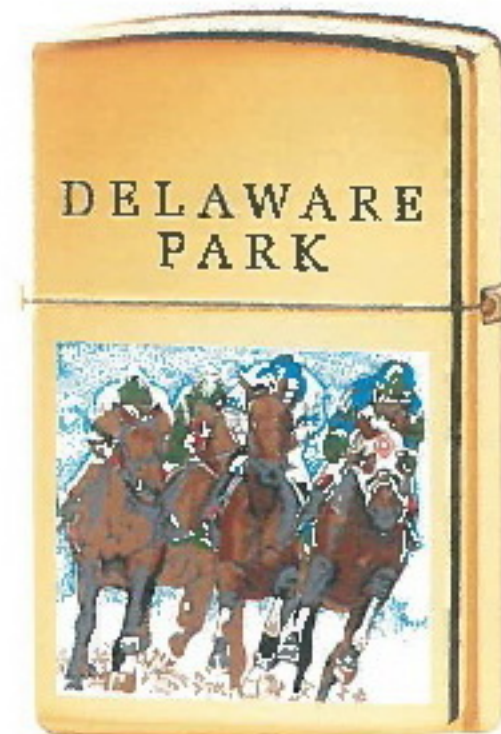

207BS B228
Bowling Street Chrome



207BS B229
Bingo Street Chrome



207BS B230
Lucky 7 Street Chrome



207BS B231
Jackpot Street Chrome



Of special interest to collectors: The authenticity of your Zippo windproof lighter is assured by the factory stamp on the bottom of the case. The code indicates month and year of manufacture. Call Zippo for a free Zippo Lighter Collectors Guide. zippo.com

7 DAY EXPRESS

All items on this page available for 7 Day Express. See Page 3 for details.

Windproof Lighters

- Show appreciation
- Portable, affordable, memorable
- Recognize exceptional service
- Employee rewards at your fingertips
- Satisfaction guaranteed
- Target sales messages with tie-ins:
 - *Bright ideas come from . . .*
 - *Lighting the way to profits*

Features

- Classic design
- Highly collectible
- Stainless steel insert
- Solid brass case construction
- Specially designed windproof chimney
- Sturdy nickel silver hinge
- Individual gift box
- Worldwide brand recognition
- Made in U.S.A. 

Slim Size Windproof Lighters

(standard packaging black plastic box)



Available Finishes and Matte Colors

1610	1630
1618	1637
1633	1654B
1639	

1600
Brushed Chrome

Imprint Areas

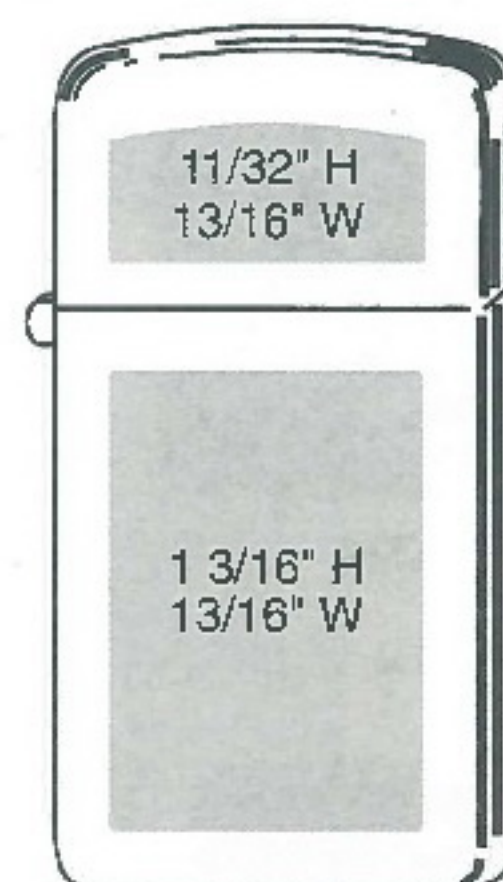

Slim Lighter

WINDPROOF LIGHTERS

Model	Description	25	100	250	500	1000+
-------	-------------	----	-----	-----	-----	-------

After Hours Series (shipping wt. 25 per carton: avg. 6 lbs. 4 oz.)

1667	Crystal Trinity	28.60	28.42	28.25	28.08	27.88
38	Gold Grill and Bars	23.27	23.08	22.95	22.75	22.55
39	Carved Diamond	55.93	55.75	55.58	55.42	55.22
388	Black Ovals	23.27	23.08	22.92	22.75	22.55
389	Silver Spears	29.93	29.75	29.58	29.42	29.22
669	Braided Silver	26.60	26.42	26.25	26.08	25.88
705	Carved Floral	55.93	55.75	55.58	55.42	55.22
706	Imperial Filigree	33.93	33.75	33.58	33.42	33.22
20106	Horse Shoe Silver	30.60	30.42	30.25	30.08	29.88
20108	American Flag	27.27	27.08	26.92	26.75	26.55

each additional surface ad copy		2.63	2.45	2.28	2.12	1.92
---------------------------------	--	------	------	------	------	------

Model	Description	50	100	250	500	1000+
-------	-------------	----	-----	-----	-----	-------

Slim Size (shipping wt. 50 per carton: 7 lbs.)

1600	Brush Chrome	11.93	11.75	11.58	11.42	11.22
1610	High Polish Chrome	13.93	13.75	13.58	13.42	13.22
1618	Black Matte	13.93	13.75	13.58	13.42	13.22
1630	Royal Blue Matte	13.93	13.75	13.58	13.42	13.22
1633	Red Matte	13.93	13.75	13.58	13.42	13.22
1637	Purple Matte	13.93	13.75	13.58	13.42	13.22
1639	Navy Blue Matte	13.93	13.75	13.58	13.42	13.22
1654B	High Polish Brass	15.27	15.09	14.92	14.76	14.56

each additional surface ad copy		2.63	2.45	2.28	2.12	1.92
---------------------------------	--	------	------	------	------	------

Exceptions

Surfaces 5 thru 9 (see diagram on page 31) can only be laser engraved.

We will waive the less-than-minimum charge on an order of 25 lighters if any other Zippo product in this catalog is ordered in minimum quantity at the same time.

Graphic Proof at no charge; product sample will be charged at 25 quantity price.

Imprint Methods

	EP	SI	LE	LA	AE
Windproof Lighters (1600 & 200 Series)					
Brush Chrome	X	X	X	X	X
Satin Chrome		X	X	X	X
High Polish Chrome	X	X	X	X	X
High Polish Brass		X	X	X	X
High Polish Gold		X	X	X	X
Black Ice		X		X	
Matte Finishes		X		X	X
EP = Etch and Paint		LA = Laser Engraving			
SI = Surface Imprint		AE = Computer Engraving			
LE = Lustre Etch					

After Hours Windproof Lighters (standard packaging 2 piece cardboard box)

Reverse lid or bottom can be custom imprinted - no imprinting available on front surface.



1667
Crystal Trinity
High Polish Chrome
Enhanced with genuine Swarovsky crystals

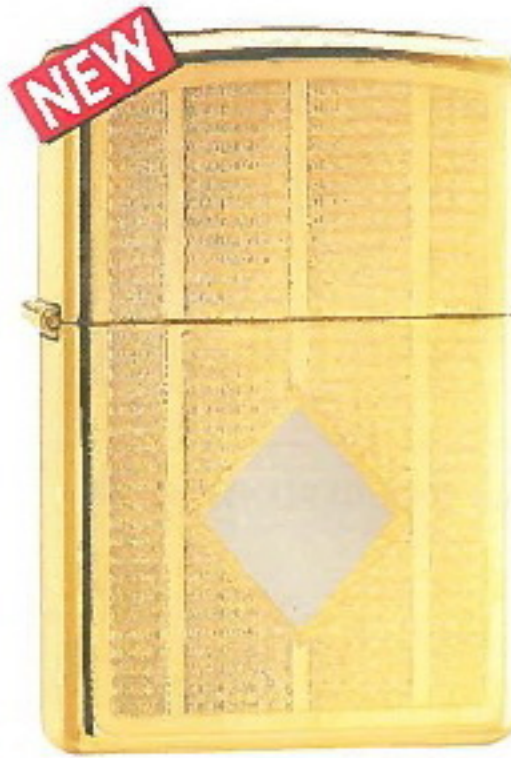

38
Gold Grill and Bars
High Polish Gold Plate



39
Carved Diamond
High Polish Gold Plate



388
Black Ovals
Street Chrome



389
Silver Spears
Street Chrome



669
Braided Silver
High Polish Chrome

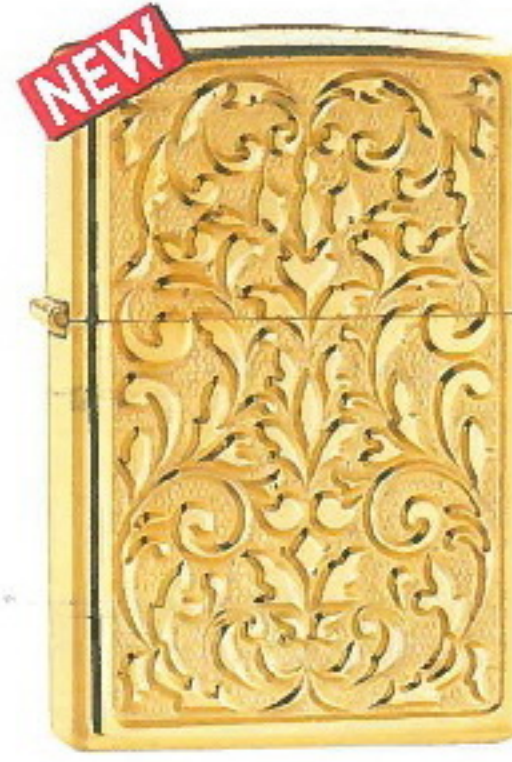

705
Carved Floral
High Polish Gold Plate



706
Imperial Filigree
High Polish Brass

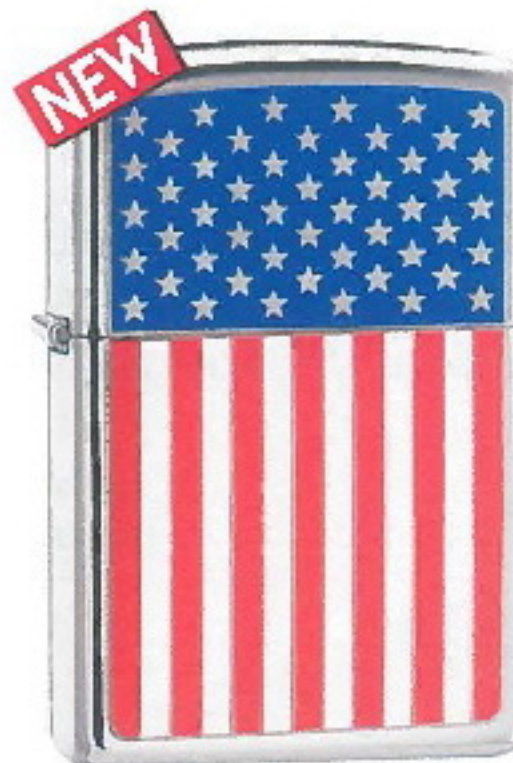

20108
American Flag
High Polish Chrome

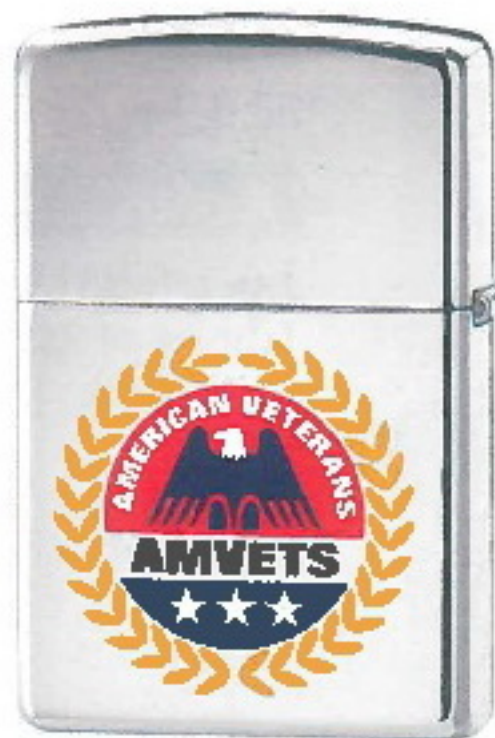

20106
Horse Shoe - Silver Black Ice



Of special interest to collectors: The authenticity of your Zippo windproof lighter is assured by the factory stamp on the bottom of the case. The code indicates month and year of manufacture. Call Zippo for a free Zippo Lighter Collectors Guide. zippo.com

7 DAY EXPRESS

All items on this page available for 7 Day Express. See Page 3 for details.

Stylus Series Pens

- Show appreciation
- Reward long-time service
- Utilize thematic tie-ins:
 - Sign on as our new partners
 - Our services are guaranteed in writing

Features

- Precision writing instrument of the highest standards
- Twist action mechanism for a smooth and easy operation
- Refills available in medium blue, medium black, and fine black
- Jewelry style grey velour gift box
- Rigid spring steel clip
- Made in U.S.A. 

Imprint Areas

Stylus Series Pens Emblem

- SQUARE 3/16"
- CIRCLE 3/16"
- OVAL 1/4" X 1/8"
- RECTANGLE 1/8" X 1/4"

Band

3/16" H
3/4" W

Barrel or Cap Imprint Area

3/16" H X 1 1/4 W"

STYLUS SERIES PENS— (Maximum three colors)

Model	Description	25	100	250	500	1000
Band Imprint (shipping wt. 25 per carton: 15 lbs.)						
5770	Purple Matte	15.26	14.85	14.41	14.23	14.06
5780	Chrome	13.26	12.85	12.41	12.23	12.06
5791	Black Matte	15.26	14.85	14.41	14.23	14.06
5800	Gold Plate	18.60	18.19	17.75	17.57	17.40
5830	Navy Blue Matte	15.26	14.85	14.41	14.23	14.06
5840	Red Matte	15.26	14.85	14.41	14.23	14.06

Emblem Imprint

 (shipping wt. 25 per carton: 15 lbs.)

Model	Description	25	100	250	500	1000
5770E	Purple Matte	17.16	16.37	15.65	15.28	14.90
5780E	Chrome	15.16	14.37	13.65	13.28	12.90
5791E	Black Matte	17.16	16.37	15.65	15.28	14.90
5800E	Gold Plate	20.50	19.70	18.98	18.62	18.23
5830E	Navy Blue Matte	17.16	16.37	15.65	15.28	14.90
5840E	Red Matte	17.16	16.37	15.65	15.28	14.90

Emblem imprint plus band imprint

add the amount shown to above prices.	25	100	250	500	1000
	2.63	2.22	1.78	1.60	1.43

• All Stylus Series pens are available with chrome appointments (clip, hat and tip). Just add a "C" to the end of model number. All pricing remains the same.

EXCEPTIONS

Imprint Colors

Price includes the product with ad copy reproduced on a silver, gold, or white ad panel in 1 or 2 colors. Laser engraving available on barrel.

Band Imprint

The band is the circular copy area located in the middle of the writing instrument barrel just below the clip. This copy area is 3/16" high by 3/4" in circumference. Unless specified, a silver band will be used on writing instruments with chrome appointments. A gold band will be supplied on all writing instruments with gold appointments. A white imprint band is available as an option upon request. Ad copy can be produced in a maximum of three (3) colors. The color of the imprint band is not considered a color.

Emblem Imprint

Zippo offers four emblem shapes (round, oval, square, and rectangle) that are attached to the clip. Please specify emblem shape. Three background colors are available: white, silver, and gold. Unless specified, a white background will be used on all emblem imprints.

Copy Limitations

Our reproduction process makes it possible to clearly reproduce extraordinary amounts of copy on the small band and emblem. However, a simple design or brief copy is recommended, because it is easier to read.

Personalization

One line of repetitive ad copy can be laser engraved or computer engraved on the cap at \$2.25 each. Minimum quantity 25 units. A full name or initials can be laser engraved on the cap at \$2.67 each. Limitations: One line, block style capital letters only, 25 letters and spaces, no color fill.(C)

Refills

Ink refills (Universal Twist)—\$1.00 each.(C)
Choice of Medium Blue, Medium Black, Fine Black

(product not shown actual size)



5770: Pen
5770E: Pen with emblem
Purple
Matte



5780: Pen
5780E: Pen with emblem (shown)
Chrome



5791: Pen
5791E: Pen with emblem (shown)
Black
Matte

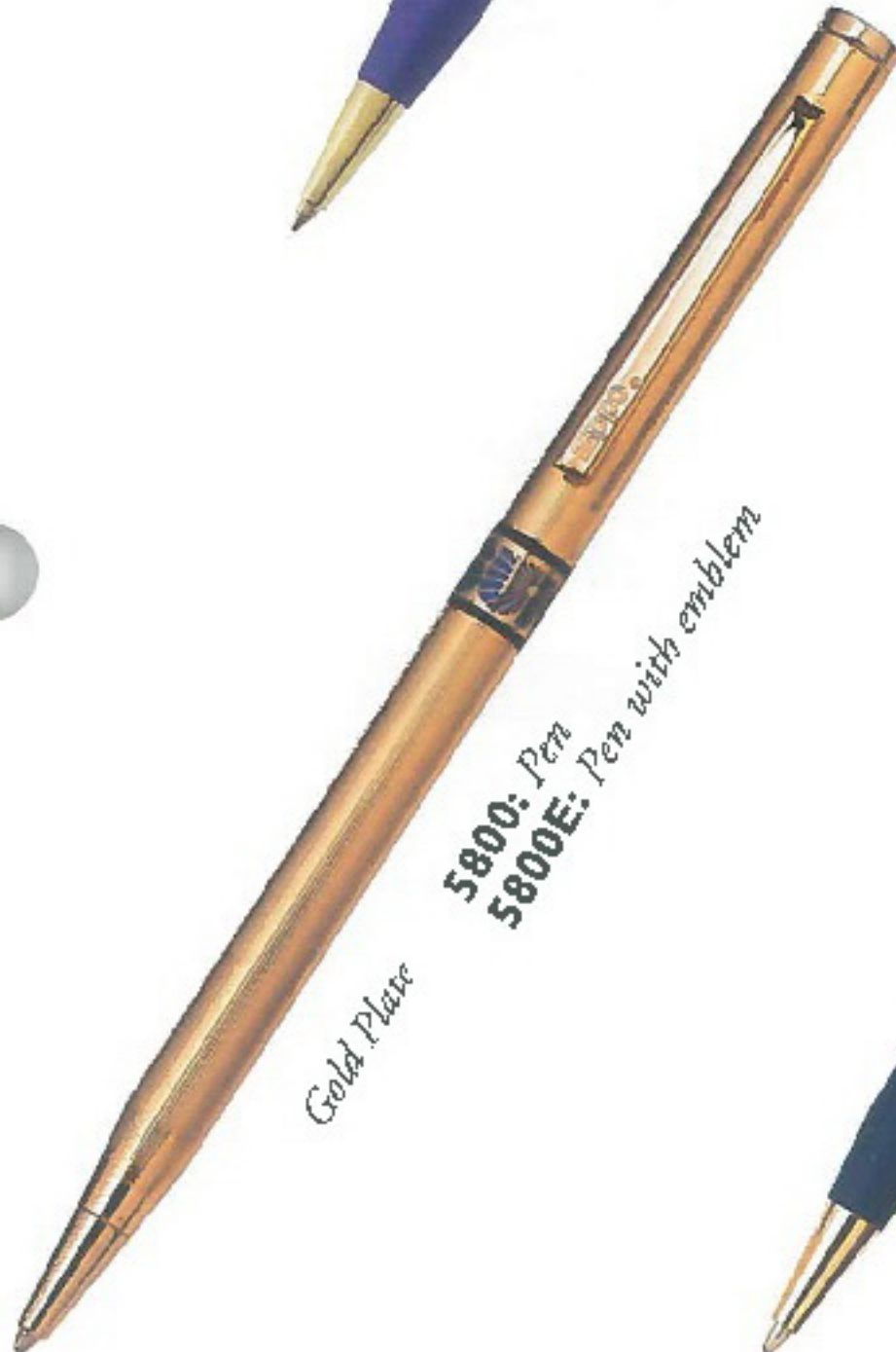

5800: Pen
5800E: Pen with emblem
Gold Plate



5830: Pen (laser imprint shown)
5830E: Pen with emblem
Navy Blue
Matte



5840: Pen
5840E: Pen with emblem
Red Matte

Standard
Packaging



5791C: Pen

Black Matte with chrome appointments

All Stylus Series pens are available with chrome appointments (clip, hat and tip). Just add a "C" to the end of model number. All pricing remains the same.

7 DAY EXPRESS

All items on this page available for 7 Day Express. See Page 3 for details.

Performer Pens

- Stimulate mail order response
- Keep your company name in front of buyers
- Promote new toll-free phone or fax numbers
- Enhance redemption programs
- Generate interest with tie-ins:
 - Sign up for great values
 - We guarantee our quality in writing

Features

- Barrel and/or cap imprint
- Solid brass construction
- Carbide tip
- Gold-plated steel clip
- Cap action mechanism
- Uses standard refills
- Individual gift box
- Made in U.S.A. 

PERFORMER PEN SERIES (Prices include 1 color imprint only)

Model	Description	50	250	500	1000	2500
Performer Pens (shipping wt. 50 per carton: 3 lbs.)						
800	Antique Gold	4.85	4.60	3.95	3.85	3.82
810	Satin Stainless	4.85	4.60	3.95	3.85	3.82
815	Gloss White	4.85	4.60	3.95	3.85	3.82
818	Gloss Black	4.85	4.60	3.95	3.85	3.82
820	Metallic Blue	4.85	4.60	3.95	3.85	3.82
821	Metallic Green	4.85	4.60	3.95	3.85	3.82
822	Gloss Burgundy	4.85	4.60	3.95	3.85	3.82
823	Metallic Grey	4.85	4.60	3.95	3.85	3.82
second surface ad copy		.75	.75	.75	.75	.75

EXCEPTIONS**Imprint Colors**

Price includes the product with ad copy **in one (1) color** or laser engraved on barrel, or laser engraved only on cap.

Gold paint and laser engraving are not available on model #800 and #810.

Additional Colors Charge

Add \$.75 per color, per unit when more than one-color ad copy is requested. One additional color only. (C)

Imprint Methods

Performer pens may be surface imprinted or laser engraved on barrel, or laser engraved only on cap.

Combination Order Pricing

Not available.

Personalization

One line of repetitive ad copy can be laser engraved on the cap at \$2.25 each. Minimum quantity 25 units. A full name or initials can be laser engraved on the cap at \$2.67 each. Limitations: One line, block style capital letters only, 25 letters and spaces, no color fill. (C).

Refills

The standard refill is medium point blue. Medium point black is available. Performer pen refills are available as follows: Medium Blue Standard #5822 and Medium Black Standard #5822* are available at \$1.00 each. (C).

Imprint Areas**Performer Pen**

(product not shown actual size)



Barrel and/or cap imprinting available on all finishes

Standard Packaging

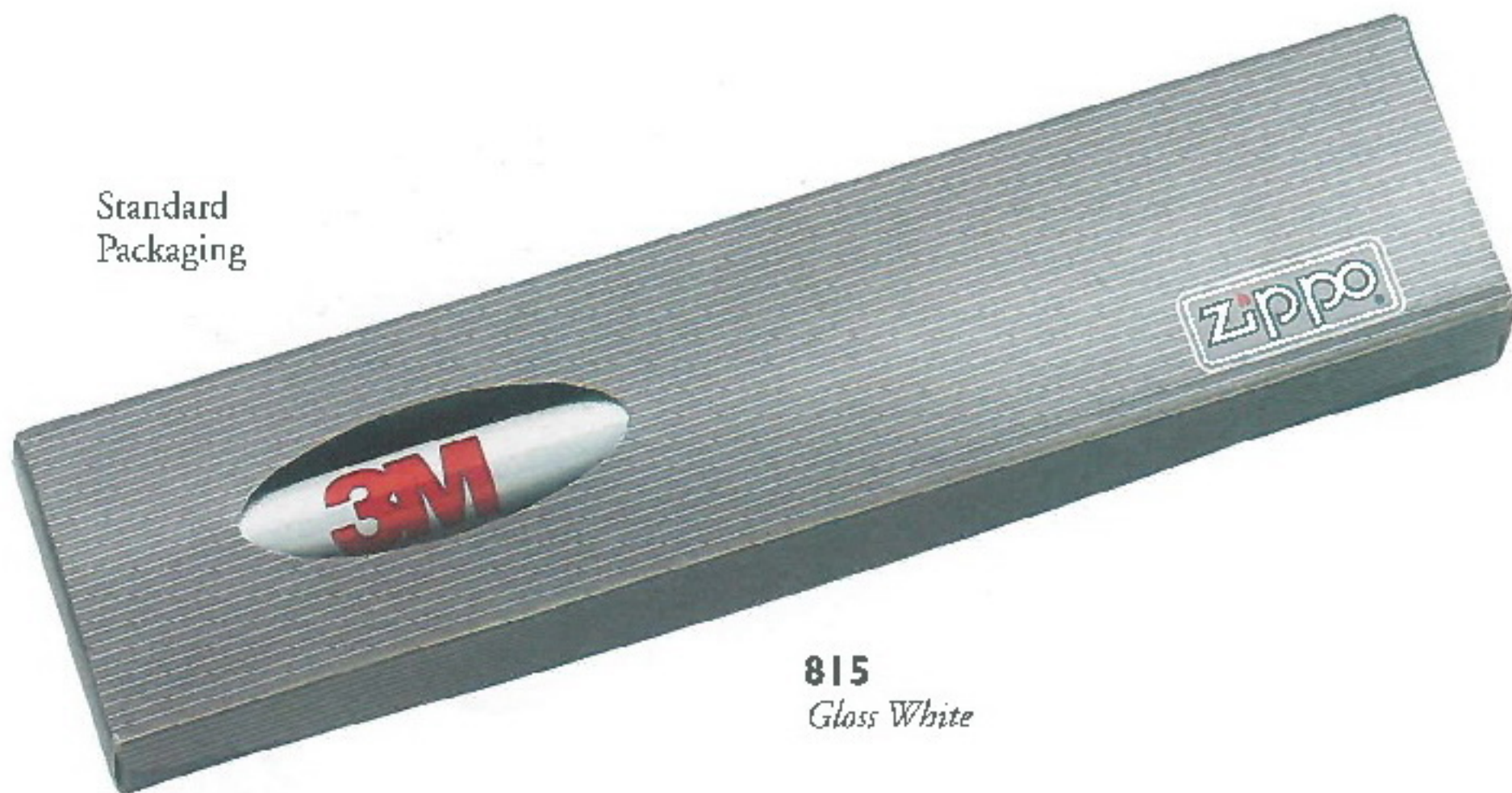

815
Gloss White

7 DAY EXPRESS

All items on this page available for 7 Day Express. See Page 3 for details.

Individual Tins

IMPRINTED INDIVIDUAL TINS

Surface Imprint (1 or 2 colors)

Laser Engrave (no color fill)

Quantity

25 or 50	\$3.38
100	2.97
250	2.53
500	2.35
1000	2.18

(C)

UNIMPRINTED INDIVIDUAL TINS

(Zippo logo only)

Quantity

No Minimum	\$.75
------------	-------

(C)

INDIVIDUAL VELOUR INSERTS AVAILABLE FOR THESE PRODUCTS

Cut-About Jr.	EZICJT
Cut-About Lite Jr.	EZICLJT
Knife/Scissors	EZIKST
Pocket Knives	EZIKT
Money Clip Knives	EZIKT
Tape Measures	EZIRT
Greenskeeper™ Golf Tools	EZIGT
Key Holders	EZIKHT
Key Rings	EZIKST
Money Clips	EZIKT
Lighters—Regular	EZILT
Lighters—Slim	EZIST

Imprint Area Individual Tin

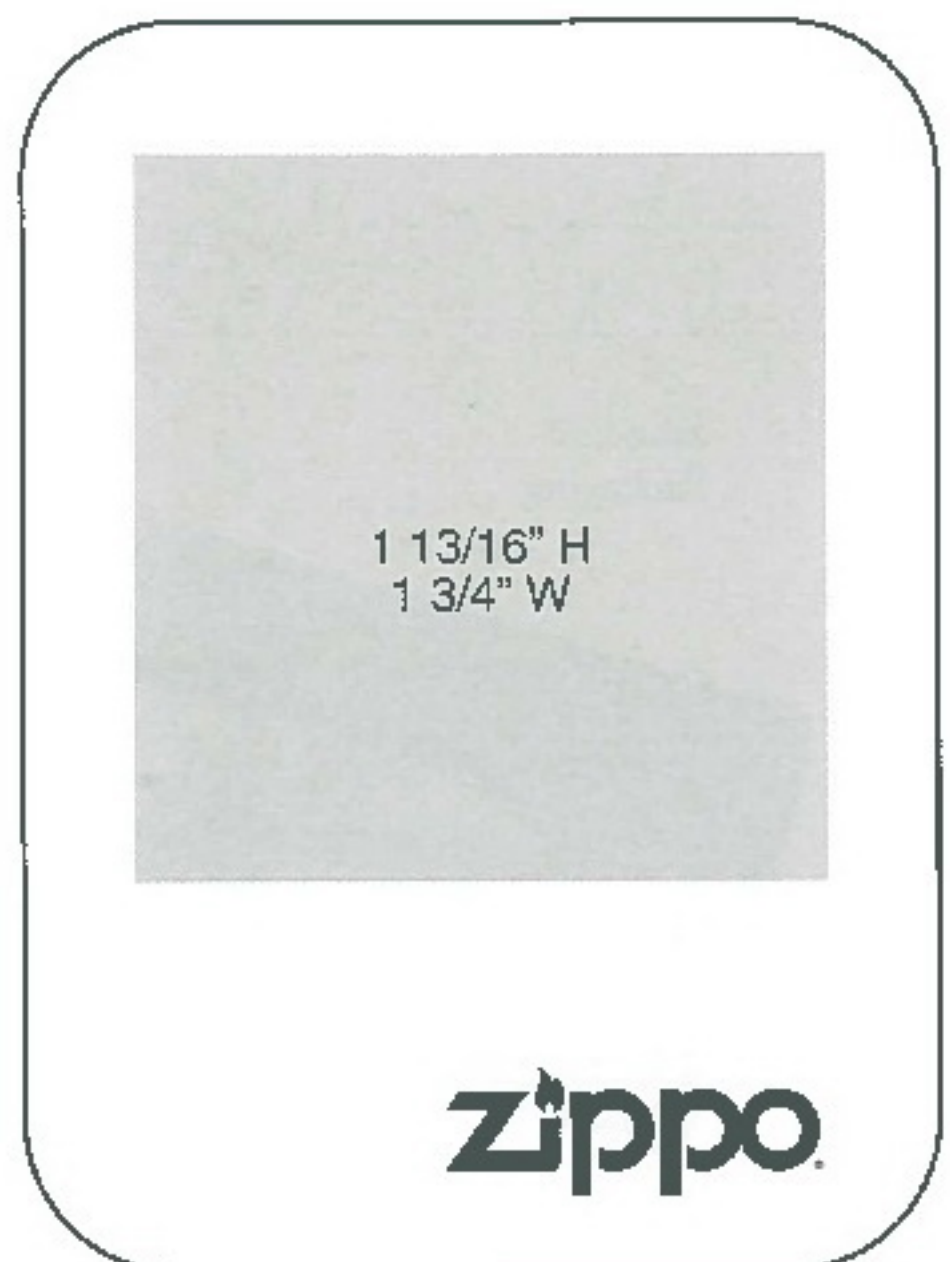

zippo



Surface Imprint

Laser Imprint

Features

- All tins are embossed with the Zippo logo as shown.
- Combination pricing: Tin with product using the same design on each piece in catalog minimums, add quantity together to establish price. Example: 50 Knife/Scissors + 50 Imprinted Tins: Use 100 piece price.
- Made in U.S.A. 

Exceptions

Not available for Full Size Cut-About Knives, Full-Size Cut-About Lite Knives, Z-Twin Knife, Belt Buckle, Pens, Cigar Cutter or Letter Openers.

Tins may be surface imprinted or laser engraved only.

7 DAY EXPRESS

All items on this page available for 7 Day Express. See Page 3 for details.

Leatherman® Sets & Dual Tins

Leatherman® micra™ Gift Set

Team up this 10-function Leatherman® micra™ with any Zippo windproof lighter and you're ready for anything. Leatherman® micra™ contains three screwdrivers, a knife, scissors, tweezers and more, yet folds to a compact 2 1/2" x 3/4" size.

Leatherman® micra™ may be personalized (see information below). Gift set includes Leatherman® micra™ and leather pouch in a 2-piece tin. Lighter price not included in the Leatherman® set pricing below. Complete the set with any customized lighter (see pages 23-34).

Leatherman® micra™ Set

Model	Description	25	100	250	500	1,000
*LTI	Leatherman Set, w/imprinted micra™	38.71	38.30	37.86	37.68	37.51
*LTP	Leatherman Set, plain micra™	36.08	36.08	36.08	36.08	36.08

* Add the cost of a lighter to above pricing to get total cost of a set.

Exceptions

No custom imprinting available on Leatherman® sheath.

Leatherman® micra™ can only be laser or computer engraved with one line of type. Maximum letters and spaces:

- Laser Engraving Complex font
17 characters
- Computer Engraving . . . Century Block font
19 characters



Dual Tins



Surface imprint shown

Dual velour inserts are available for most products. Please call Zippo for availability.

Dual Tin Imprint Area (not shown)
2 9/16"H x 2 7/8"W

IMPRINTED DUAL TINS

Surface Imprint (1 or 2 colors)
Laser Engrave (no color fill)

Quantity	
25 or 50	\$6.60
100	6.19
250	5.75
500	5.57
1000	5.40

(C)

UNIMPRINTED DUAL TINS

(Zippo logo only)

Quantity	
No Minimum	\$3.97

(C)



All items on this page available for 7 Day Express. See Page 3 for details.

Combination Gift Sets

Twice as useful, twice as memorable, twice the impact. A Zippo combination gift set makes a lasting impression. Almost any two Zippo products can be paired to create a customized gift tailored to the occasion. See page 44 for available combinations.

Combination Gift Sets

- Establish prestige
- Symbolize corporate achievement
- Commemorate special occasions
- Reward long-time service
- Celebrate new partnerships
- Observe company anniversaries

Exception

The following products are not available in combination gift sets: Cut-About Knives, Cut-About Lite Knife, Z-Twin Knife, Letter Openers, Belt Buckle, Performer Pens, Cigar Cutter and Stylus Pens.



Tape Measure with
Regular Lighter



Regular Lighter with
Greenskeeper™ Golf Tool



Key Holder with
Greenskeeper™ Golf Tool



Pocket Knife with
Tape Measure



Rectangle Key Ring with
Pocket Knife



Slim Lighter with
Key Holder



Regular Lighter with
Tape Measure



Greenskeeper™ Golf Tool
with Tape Measure

Performer Pen Combination Gift Sets



Performer Pen with Pocket Knife



Performer Pen with Pocket Knife/Scissors



Performer Pen with Regular Lighter



Performer Pen with Full Size Cut-About Knife



Performer Pen with Greenskeeper™ Golf Tool



Performer Pen with Tape Measure



Performer Pen with Key Holder

Team a Performer Pen with another gift from Zippo's knife or metal specialty collection, and you've got an unbeatable combination. Your logo or message will get double the exposure, and your client will get double the use from these quality, functional gifts.

Each Performer Pen combination gift set is packaged in a handsome presentation box. See page 44 for available combinations.

Exception

The following products are not available in Performer Pen combination gift sets: Z-Twin Knife, Letter Openers, Cigar Cutter and Belt Buckle.

Stylus Pen Combination Gift Sets

Zippo combination gift sets are packaged in distinctive gift boxes as shown, at no extra cost. To calculate the price of each set, simply add together the prices of each individual product.

Stylus Pen with Key Holder



Stylus Pen with Pocket Knife



Stylus Pen with Pocket Knife/Scissors



Stylus Pen with Tape Measure



Stylus Pen with Slim Lighter

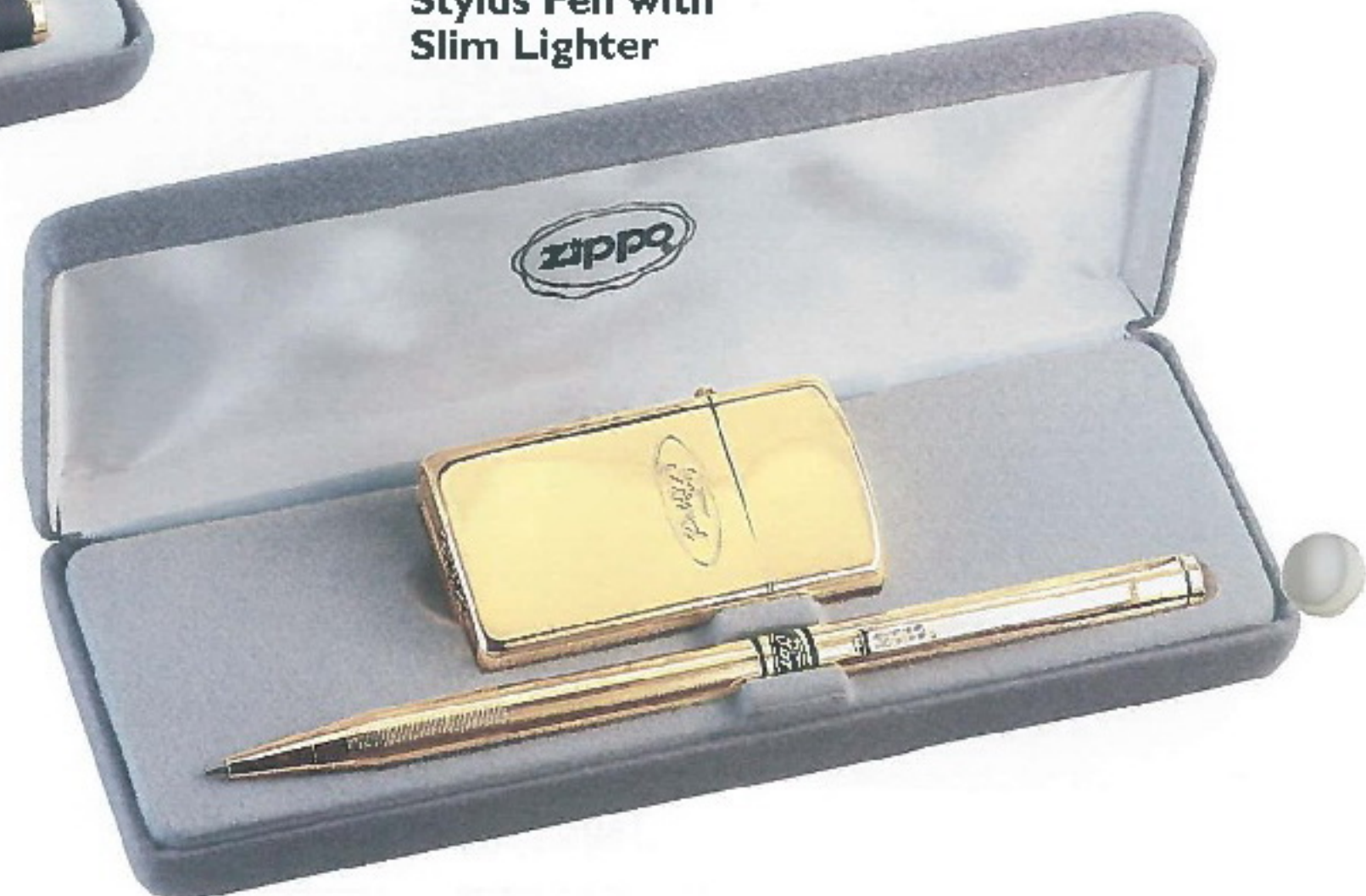

Exception

The following products are not available in Stylus Pen combination sets: Cut-About Knives, Cut-About Lite Knives, Z-Twin Knife, Letter Openers, Cigar Cutter, Belt Buckle, and Performer Pens.

Our standard packaging is shown on each of the product pages throughout this catalog. In addition, these attractive packaging options are available.

We can create custom package configurations to meet your needs. Special packaging is not available for certain Zippo products, so please ask your distributor for availability and prices. (C)



50R Regular Gift Kit
50S Slim Gift Kit

Packaging Options

OPTIONAL PACKAGING

Gift Kit (includes flint and fuel)	
50R Regular Gift Kit	Add 3.30 to cost of any regular lighter
50S Slim Gift Kit	Add 3.30 to cost of any slim lighter
Reg. Lighter Pouch Gift Set Plain	7.97 + cost of lighter
Reg. Lighter Pouch Gift Set w/Imprint	10.60 + cost of lighter
122141 Lighter Pouch with Clip, Brown Plain	5.97
122141* Lighter Pouch with Clip, Brown with Imprint	8.60

(C)



122141*
Regular Lighter
(Laser imprint shown)



(not shown actual size)



Regular Lighter and
Pouch Gift Set

CIGAR CUTTER

Model	Description	25	100	250	500	1000
9501	Cigar Cutter	37.93	37.52	37.08	36.90	36.73
9501CCGS	Cigar Cutter Gift Set (add to price of any lighter)	40.43	40.02	39.58	39.40	39.23
	second surface ad copy	2.63	2.22	1.78	1.60	1.43



9501
Cigar Cutter



Standard
Packaging

Personalized Engraving

Computer Engraving

Most Zippo products can be personalized with a name or initials. The message is engraved with a diamond tool, allowing the metal finish to show through.

Consecutive numbering is available.

For complete details about Zippo's personalized computer engraving options, contact your specialty distributor.

Without Colorfill

Samples of our most popular engraving type styles are shown below. If a type style is not specified, CB (Century Block) will be used.

- CB Century Block
- RB Roman Block
- DB DOUBLE BLOCK
- FO Futura Outline
- CS Connecting Script
- FA FIFTH AVENUE
- OE Old English



Font used:
Roman Block



Font used:
Connecting Script

Colorfill / Matte

These type fonts may be engraved with or without colorfill. Matte products use only these fonts and cannot be colorfilled. If a font style is not specified, SB (Simple Block) will be used.

- SB Simple Block
- CT CONTEMPORARY
- CU Cursive

Laser Engraving (with no colorfill)

Most Zippo products can be laser engraved with a name or initials. Laser engraving marks only the surface of the product, and cannot be colorfilled. The three available type styles are identified on the products shown here. Available on our 7 Day Express program, laser engraving is a quick turnaround personalization option.

Consecutive numbering is available.

For complete details about Zippo's personalized laser engraving options, contact your specialty distributor.



Font used:
Simple Block

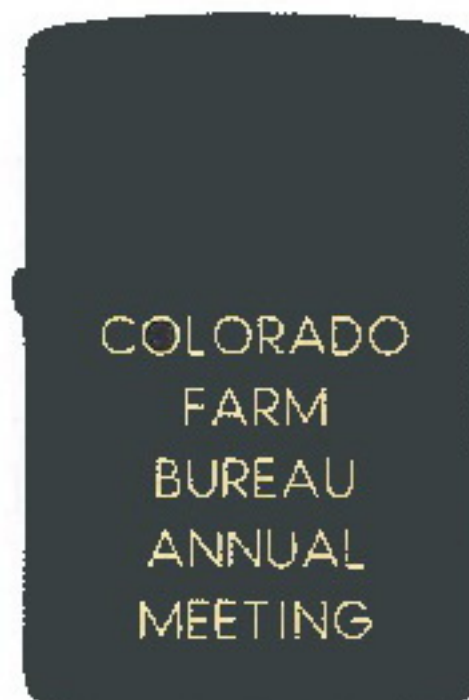

Font used:
Complex



Font used:
30640A
(Similar to simple block)

Imprinting Methods

Zippo is proud of its reputation for producing the highest quality imprinting in the specialty advertising business. We have the capability of creating just the right image for you. We offer a variety of customization methods including our newest—polycarbonate chip and glow in the dark paint (See page 4).

Surface Imprint (SI)

Surface imprinting is a silk-screening process using a separate screen for each color. Durable epoxy paint is applied to the finish, building a rich and vibrant image. The product is oven-cured, bonding the epoxy imprint to the surface, where it becomes an integral part of the finish.



Computer Engraving (AE)

The crisp, clean look of computer engraving has become one of the most popular customization methods Zippo offers. Skilled operators use either the rotary engrave or diamond cut method to inscribe an image into the product. Each engraving machine is custom programmed through a keyboard or from digitized artwork.



Laser Engraving (LA)

Laser engraving is one of the most popular customization method offered by Zippo. The state-of-the-art process allows tremendous flexibility in reproducing your artwork on our products. Our laser engravers are computer-programmed to generate crisp, accurate replication of your artwork. Laser Engraving is now available on most Zippo products. Show us your artwork and we will tell you if Laser Engraving will work for you.

Etch and Paint (EP)

Zippo's etch and paint method produces an attractive, durable imprint. A reversed image is silk-screened on the Zippo product with an acid-resistant paint. Leaving exposed only the areas to be etched, the product is dipped in an acid bath, which etches all unprotected areas. Paint colors are screened one at a time into the etched cavities, resulting in a colorful graphic that is permanently defined in the surface.



Lustre Etch (LE)

The procedure for luster etch is the same as etch and paint through the acid bath. No colors are used for luster etch; instead, the product is etched and then plated. Skillful hand or machine buffing defines the high and low areas of the design to create a subtle dimensional effect.



Stylus Pen Imprints

Zippo writing instruments may be customized with a band imprint, an attached emblem, or a combination of both. The multi-color process developed exclusively by Zippo ensures sharp, high quality image replication in a very small area.

Imprint bands are made from a three-part laminate process which creates crisp, vivid images. To protect the image, the band is covered with a clear Teflon ring and then heat sealed.

Emblem imprints are produced by the same laminate method. The design is protected by a crystalline dome, which enhances the image with a three-dimensional look.



Performer Pen Imprints

The imprinting method used on our Performer Pen Series is a state-of-the-art computer controlled silk-screening process. The image is applied one color at a time with custom paint and high density mesh screens to create a crisp, lasting impression.

Computer Graphic Proofs

Computer-generated color paper graphic proofs are available upon request at no cost. The presentation folder features your company's full-color logo on a variety of Zippo products; ideal for product presentation or product copy approval. It's also a quick, simple way to stimulate additional product ideas and sales.

When requesting a graphic proof, please indicate which product the artwork should be made for, in order to produce a complete graphic.



Item	Page No.
Under \$5	
Key Rings	19-20
Performer Pens	37-38
\$5 to \$10	
Pocket Knives	11-12
Money Clips	13-14
Tape Measures	15-16
Greenskeeper™ Golf Tools	17-18
Key Rings	19-20
Key Holders	21-22
\$10 to \$15	
Pocket Knives	11-12
Pocket Knives w/Money Clip	11-12
Letter Openers	13-14
Tape Measures	15-16
Greenskeeper™ Golf Tools	17-18
Greenskeeper™ Golf Tools w/Money Clip	17-18
Belt Buckle	21-22
Buckle with Belts	21-22
Windproof Lighters	23-34
Stylus Pens	35-36
\$15 to \$20	
Cut-About Lite Knives	5-6
Cut-About Junior Knives	7-8
Cut-About Lite Junior Knives.....	7-8
Pocket Knife/Scissors	9-10
Pocket Knife/Scissors w/Money Clip	9-10
Windproof Lighters	23-34
Stylus Pens	35-36
Over \$20	
Cut-About Knives.....	5-6
Cut-About Knife and Sheath Gift Sets	5-6
Z-Twin Knife	7-8
Pocket Knife/Scissors	9-10
Cigar Cutter	45
Windproof Lighters	23-34
Stylus Pens	35-36
Leatherman® Gift Sets.....	40
Combination Gift Sets.....	41
Performer Pen Combination Gift Sets	42
Stylus Pen Combination Gift Sets	43

Miscellaneous Information

Emblem Attaching

We do not manufacture emblems, but we will attach emblems furnished to us at \$.92 each, any quantity.* Emblems must be flat and smooth on the back. (C)**

* When customer supplies emblems, please submit 12 extra samples for testing as they must pass Zippo's quality control standards and specifications.

** Custom emblems can be ordered and manufactured from an outside source. If interested, please call for information on pricing, set-up charges, delivery schedule, etc.

Mailers

Individual mailers for most metal products—\$.50 each, includes insertion. (C)

Individual Fulfillment

Available upon request. Please contact Zippo for pricing.

Sales Tax

(State and Local)

State and local sales tax will be charged on each order based upon the tax rates of the shipping address. No sales tax will be charged if sales tax exemption certificate is supplied.

Electronic Art

We can accept computer generated artwork. Illustrator® and Freehand® files are preferred. Disk types accepted are 3.5 floppy, zip, syquest (44, 88 & 200) and cd. Artwork can be e-mailed to the attention of Bill Galey at: artwork@zippo.com

Customer Supplied Materials

Customer supplied materials can be inserted or applied for an additional cost of .35 each. (C)

Drop Shipments: For drop shipments, a tax exemption certificate must be on file at Zippo.

Artwork Disclaimer: "Zippo has sole discretion to accept or reject artwork or images to be placed on any product offered. Zippo also reserves the right to reject artwork based on copyright infringement unless written permission from the source accompanies the order/artwork. Anyone submitting artwork agrees to indemnify Zippo for any alleged copyright infringement."



THE WORLD FAMOUS
ZIPPO

GUARANTEE

Any Zippo metal product, when returned to our factory, will be put in first-class mechanical condition free of charge, for we have yet to charge a cent for the repair of a Zippo metal product, regardless of age or condition.

The finish, however, is not guaranteed.

This guarantee gives you specific legal rights and you may also have other rights which vary from state to state.



Zippo Manufacturing Company
33 Barbour Street
Bradford, PA 16701 U.S.A.

The famous Zippo Lifetime Guarantee is your assurance that every Zippo product is made to the same exacting standards of quality materials and craftsmanship. When you give a Zippo product, you are giving an enduring testimonial to your discriminating taste.



... and you thought we only made lighters!