



## TEP-0500-IMX6UL / TEP-0700-IMX6UL Quickstart Guide

### 1 Safety Precautions

Thank you for purchasing a TechNexion TEP series device. This installation guide will be helpful in the installation, wiring and inspection of your TechNexion HMI. Before using the product, please read this guide to ensure correct use. You should thoroughly understand all safety precautions before proceeding with the installation, wiring and operation. Place this instruction sheet in a safe location for future reference.

#### 1.1 Storage and Installation

- Keep the device dry. Precipitation, humidity, and all types of liquids or moisture can contain minerals that will corrode electronic circuits. If your device does get wet, allow it to dry completely.
- Do not use or store the device in dusty, dirty areas. Its parts and electronic components can be damaged.
- Do not store the device in hot areas. High temperatures can shorten the life of electronic devices, damage batteries, and warp or melt certain plastics.
- Do not store the device in cold areas. When the device returns to its normal temperature, moisture can form inside the device and damage electronic circuit boards.
- Do not attempt to open the device. This product needs to be installed by qualified personnel.
- Do not drop, knock, or shake the device. Rough handling can break internal circuit boards and fine mechanics.
- Do not paint the device. Paint can clog the parts and prevent proper operation.
- Unauthorized modifications or attachments could damage the device and may violate regulations governing radio devices.

#### 1.2 Wiring

- Make sure that the available power source matches the required input power of the device. Failure to observe this caution may result in electric shock or fire.
- Do not power the unit by DC input when you apply power over the PoE (RJ45).

#### 1.3 Maintenance and Inspection

- Do not touch any internal or exposed parts of the device as electrical shock may result.
- Do not remove operation panel while power is on. Otherwise electrical shock may result.
- Do not use harsh chemicals, cleaning solvents, or strong detergents to clean the device.
- Be sure the ventilation holes are not obstructed during operation. Otherwise malfunction may result due to bad ventilation or overheating.

These suggestions apply equally to your device, battery, charger, or any enhancement. If any device is not working properly, take it to the nearest authorized service facility for service.

### 2 Dimensions

TEP-0500-IMX6UL

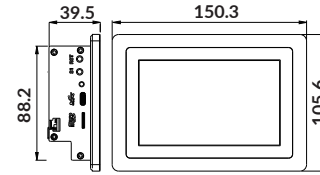

Unit : mm

TEP-0700-IMX6UL

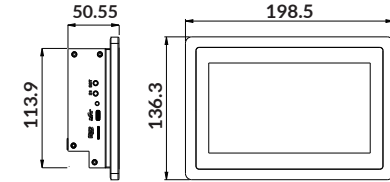

### 3 Installation Instructions

This section describes the mounting procedures for the TEP series device. The material in area of the mounting must provide sufficient strength for safe mounting of this HMI.

#### 3.1 Cut-out Dimensions

TEP-0500-IMX6UL

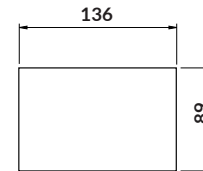

Unit : mm

TEP-0700-IMX6UL

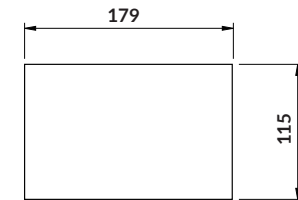

#### 3.2 VESA Mounting

This device is compatible with VESA MIS-C Standard 35\*75mm. There are 4 VESA MIS-C (M4) mounting holes on the rear side of the device. M4 screws with at least 4mm head-to-tip length are required to secure this device.

TEP-0500-IMX6UL

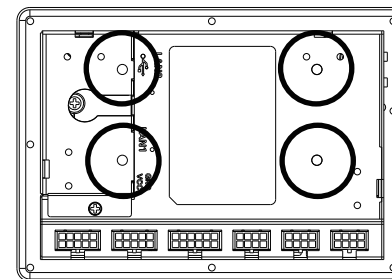

TEP-0700-IMX6UL

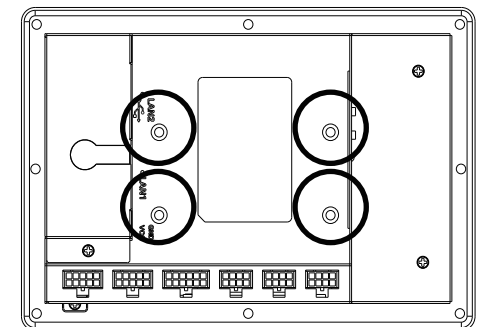

### 3.3 Rear Mounting and Mounting Clips Installation (TEP-0500-IMX6UL only)

There are 5 mounting clips required for rear mounting.

TEP-0500-IMX6UL

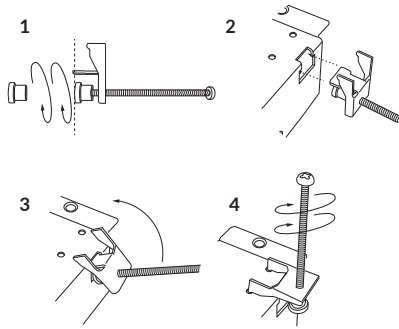
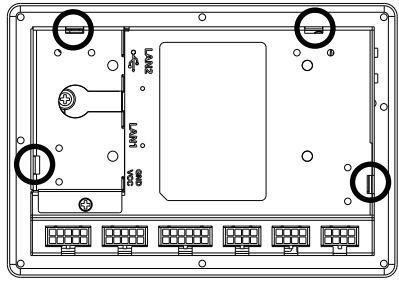

### 3.4 Surface Mounting Installation

There are 8 mounting holes (M4) on the rear side of the device required for surface mounting. M4 screws with at least 5mm head-to-tip length are required to secure this device.

TEP-0500-IMX6UL

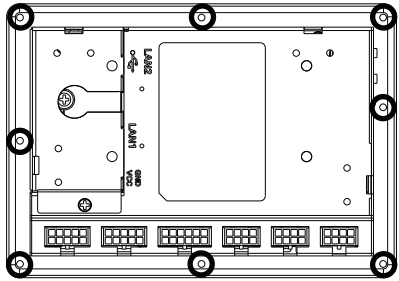

TEP-0700-IMX6UL

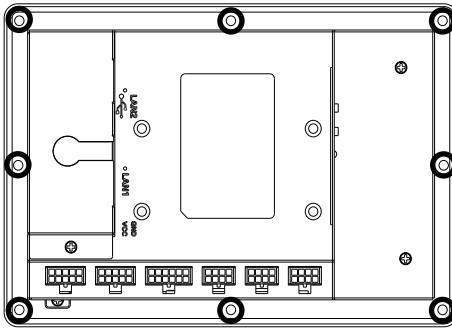

## 4 External Connectors

TEP-0500-IMX6UL

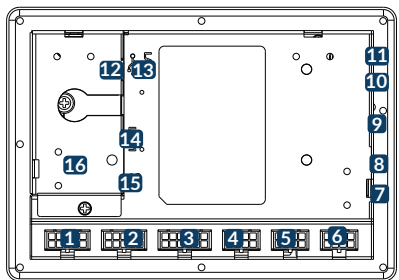

TEP-0700-IMX6UL

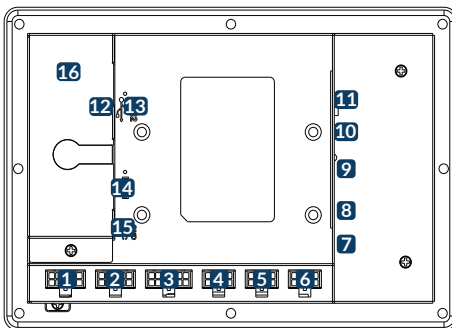

No.	Description	No.	Description
1	RS-XXX1 (Serial Port) connector	9	LED Light indicator
2	RS-XXX2 (Serial Port) connector	10	S1 Boot Select button
3	CAN Bus connector	11	Reset button
4	GPIO1 connector	12	USB Host connector
5	GPIO2 connector	13	LAN2 RJ45 connector
6	GPIO3 connector	14	LAN1 RJ45 and PoE (optional)
7	MicroSD cardslot	15	Power Input connector
8	USB OTG (Type-C) connector	16	Grounding screw

## 5 Pin Definition

### 5.1 Serial Port Connector (RS-XXX1/RS-XXX2)

Port	Pin #	RS-XXX1 Signal	Device	RS-XXX2 Signal	Device
	1	GND		GND	
	2	SERIAL1A_TXD	ttymxc0	SERIAL2A_TXD	ttymxc2
	3	SERIAL1A_RXD	ttymxc0	SERIAL2A_RXD	ttymxc2
	4	NC		NC	
	5	NC		NC	
	6	GND		GND	
	7	SERIAL1B_TXD	ttymxc1	SERIAL2B_TXD	ttymxc3
	8	SERIAL1B_RXD	ttymxc1	SERIAL2B_RXD	ttymxc3
	9	NC		NC	
	10	NC		NC	

Header: Molex 43045-1012 (10-pin Micro-Fit 3.0).

Cable receptacle: Molex 43025-1000 (10-pin Micro-Fit 3.0) plug with crimp contact Molex 43030-0007. Shielding with 6.3mm male spade terminal connector.

### 5.2 CAN Bus Connector (CANBus)

Port	Pin #	Signal	Interface
	1	GND_CAN	
	2	CAN1A_TERM_P	can1
	3	CAN1A_P	can1
	4	CAN1A_N	can1
	5	CAN1A_TERM_N	can1
	6	NC	
	7	GND_CAN	
	8	CAN1B_TERM_P	can2
	9	CAN1B_P	can2
	10	CAN1B_N	can2
	11	CAN1B_TERM_N	can2
	12	NC	

Header: Molex 43045-1212 (12-pin Micro-Fit 3.0).

Cable receptacle: Molex 43025-1200 (12-pin Micro-Fit 3.0) plug with crimp contact Molex 43030-0007. Shielding with 6.3mm male spade terminal connector.

### 5.3 Digital I/O Connectors (GPIO1/GPIO2/GPIO3)

Port	Pin #	GPIO1/2 Signal	GPIO1/2 Description	GPIO3 Signal	GPIO3 Description	Voltage
	1	GPIO1A/2A	DIG_IN1/OUT1	GPIO2A	ADCI_INO	3.3V
	2	GPIO1B/2B	DIG_IN2/OUT2	GPIO3B	PWM_OUT or DIG_IN2/OUT2	3.3V
	3	GND_DIO	Ground for digital I/O	GND_DIO	Ground for digital I/O	
	4	NC		NC		
	5	GPIO1C/2C	DIG_IN5/OUT5	GPIO3C	PWM_OUT or DIG_IN5/OUT5	3.3V
	6	GPIO1D/2D	DIG_IN6/OUT6	GPIO3D	PWM_OUT or DIG_IN6/OUT6	3.3V
	7	VCC_DIO	Supply output	VCC_DIO	Supply output	3.3V
	8	NC		NC		

Header: Molex 43045-0812 (8-pin Micro-Fit 3.0).

Cable receptacle: Molex 43025-0800 (8-pin Micro-Fit 3.0) plug with crimp contact Molex 43030-0007. Shielding with 6.3mm male spade terminal connector.

## 6 Software Installation

The unit is preloaded with software that can download and install a selection of OS images over hardwired network. Simply connect a network to the unit through the Ethernet LAN RJ45 connector and power it up, then follow the steps on the screen to load the software. Local proxies will interfere with this process. For more information, go to our Knowledge Base at: <https://www.technexion.com/support/knowledge-base/>

- All Rights Reserved. No part of this document may be photocopied, reproduced, stored in a retrieval system, or transmitted, in any form or by any means whether, electronic, mechanical, or otherwise without the prior written permission of TechNexion Ltd.
- No warranty of accuracy is given concerning the contents of the information contained in this publication. To the extent permitted by law no liability (including liability to any person by reason of negligence) will be accepted by TechNexion Ltd., its subsidiaries or employees for any direct or indirect loss or damage caused by omissions from or inaccuracies in this document.
- TechNexion Ltd. reserves the right to change details in this publication without notice. Please download the most updated version at: <https://www.technexion.com/support/download-center/>