

Type IC, Wet & Air-Tight



Project: _____

Location: _____

Trim Finish: _____ Qty: _____

Notes: _____

DESCRIPTION

Recessed 6" Round LED With Integral Driver In Connection Box.
Fits Where No Other Recessed Fixture Can.

FEATURES & BENEFITS

- 1/2" Thin - Install Directly Under Joists, Maximum Layout Flexibility
- Driver Inside Connection Box - No Junction Box Needed
- Fast & Easy To Install - Save On Labour
- Type IC Rated - No Housing Required
- CRI 90+ for True Colour Rendering
- Wide Trim - No More Goof Rings
- Wet Location Approved

MOUNTING

Cut Hole In Ceiling And Snap Fixture In Opening With Attached Spring Clips.
1 1/2" Above Ceiling Clearance Required For Driver.

SPECIFICATION	
Applications	Recessed Ceiling, Showers & Soffits
Energy Used	17 W
Colour Temperature	2700 K
Light Output	950 lm
Halogen Equivalent	90 W
Beam Angle	110°
CRI	90 +
Driver Input	120V AC or 277V-347V
Power Factor	0.98
Dimming	TRIAC Dimmers 5% - 100%
Approved Location	Insulated Ceiling, Wet Locations
Air Tight	Yes
IP Rating	IP 54
Ambient Temperature	-40° F (-40° C) to +104° F (+40° C)
Projected Life	70% Light Output at 50,000 Hours
Certification	cULus, Energy Star, T24
Warranty	10 Year on Residential 5 Year on Commercial Applications

DIMENSIONS

ID 6 1/8" OD 7 1/2" Cut Out 6 1/4" to 6 1/2"

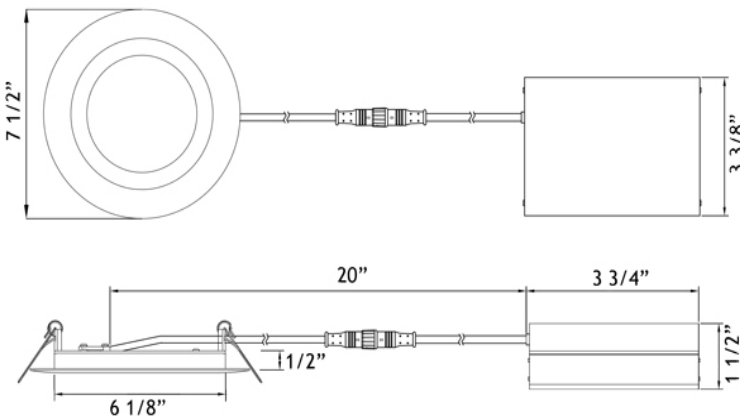

Driver Included

Cable Rating FT4 / CM

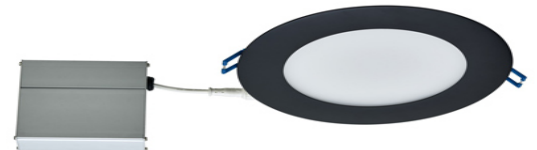

Trim Options



White

Black

Brushed Nickel

Brushed Copper

COMPLIANCE



CHARACTERISTICS

Body: Durable, Die Cast Aluminum Alloy for Optimal Heat Dissipation.
Paint: Oil Based Spray Painted - Scratch Resistant And Smooth Finish.
LEDs: 66 Pieces Of Custom Packaged LM80 Epistar 2835. CRI > 90.
 Guaranteed 98% Lumen Maintenance After 6,000 Hours.
 Strict Binning To Ensure Consistent Light Colour.
Driver: 4th Generation Lotus Designed. Field Proven Since 2011.
Connection Box: Patented Invention By Lotus LED Lights.
 Saves Contractors Labour On Installation.
Testing: Every Single Driver Is Powered For Minimum 24 Hours
 Together With The Fixture That It Is Shipped With.
 Every LED Is Visually Checked Before And After The PCB Is Mounted On The Fixture.
 No Random Tests - We Hand Test Every Fixture & Driver.

LOTUS LED Lights

LED lighting facts
A Program of the U.S. DOE

Light Output (Lumens)	950
Watts	17
Lumens per Watt (Efficacy)	55.88

Color Accuracy <small>Color Rendering Index (CRI)</small>	90
--	-----------

Light Color <small>Correlated Color Temperature (CCT)</small>	2700 (Warm White)
--	--------------------------



All results are according to IESNA LM-79-2008: Approved Method for the Electrical and Photometric Testing of Solid-State Lighting. The U.S. Department of Energy (DOE) verifies product test data and results.

Visit www.lightingfacts.com for the Label Reference Guide.

Registration Number: K53C-N6K2OL (10/25/2017)
 Model Number: LL6R-27K
 Type: Luminaire - Downlight

PHOTOMETRIC DATA OF A LAB TESTED SAMPLE

MODEL: LL6R-27K	LAMP FLUX: 980 LM
VOLTAGE: 120 V	LUMENS / POWER: 59 LM/W
POWER: 16.6 W	CENTRAL INTENSITY: 367 CD
PF: 0.99	BEAM ANGLE: 108 DEGREES

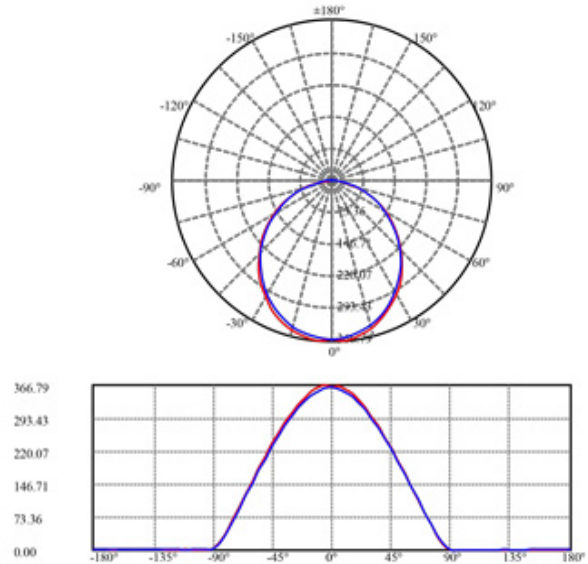
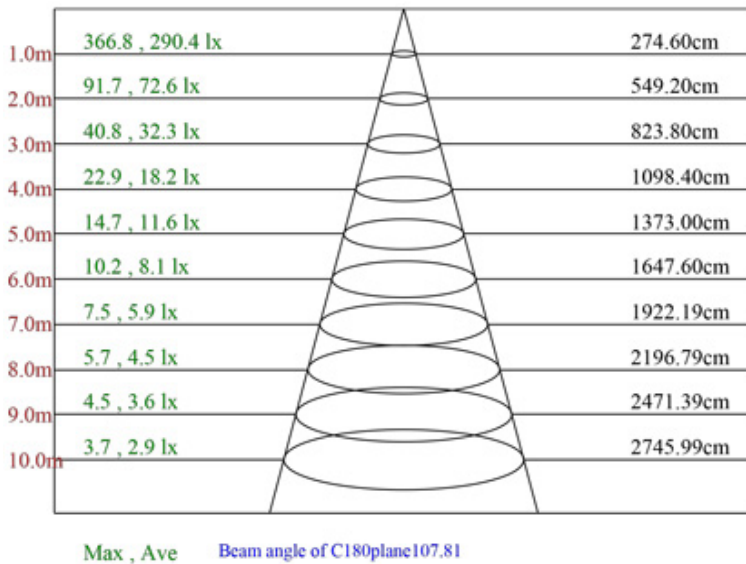

ORDERING GUIDE

Example: LL6R -27K - WH



LL6R - 27K -

WH : White
 BK : Black
 BN : Brushed Nickel
 BC : Brushed Copper

Order 277V - 347V Optional Driver Separately As cat # LLL-LD2050H



ACCESSORIES

-  Low Volage Extension Cables
6ft - cat # EXC6, 20ft - cat # EXC20
Max 40 ft Extension Allowed
-  Flanged Rough-In Plates - cat # LRP6
-  Flat Rough-In Plates - cat # RIP612



Warehouses

Vancouver Toronto Las Vegas Naples Philadelphia Dallas Seattle Chicago Denver

tel: 1-844-24-LOTUS (56887) fax: 1-877-561-6306 www.lotusLEDlights.com