

Project: _____ Type: _____ Qty: _____



FEATURES

Modular design, field replaceable LED module, trim, beam lens, and accessories.

Interchangeable secondary reflector options for glare control and maximum visual comfort.

Quiet ceiling achieved through deep regress.

Precise light control, 15°/24°/36°/50° TIR lens and Reflector lens options.

Offered standard with flicker free dimming to 1% and premium, fade-to-off dimming (.5%), option available.

Type IC Rated (approved for direct contact with insulation).
Two, Three and Four gang (clusters) available upon request.

SPECIFICATIONS

M35

STD - 1.57"

1.37"

3W - 1.97" H
5W - 2.76" H
7W - 3.54" H

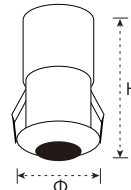
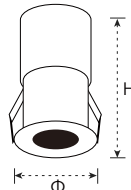
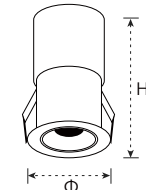
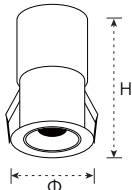

NRW - 1.97"

WDT - 2.28"

RDL - 2.36"

SQL - 3.15"

SQT - 2.36"

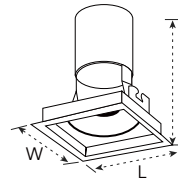
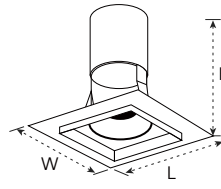
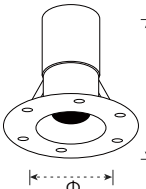
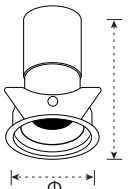
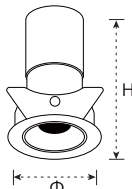

1.77"

2.17"

1.77"

2.17"

1.97"

Input Voltage	100-277V AC
Wattage	3W / 5W / 7W
Delivered Lumens	240Lm - 560Lm
LED	<3-Step MacAdam Ellipse (2-Step Available)
CCT	27K, 30K, 35K, 40K
CRI	>90Ra
Adjustability	Max Tilt Angle 30° / Horizontal Rotation Angle 355°
Lamp Life	50,000Hr
Environment	IP20 & IP44
Heat Sink	Aluminum body with oxidized powder coating
Trim	Die-cast Aluminum
Operating Temp	-4° F - 104° F

Order Code

ORDER CODE EXAMPLE: GO2MINI-M35-BEV-STD-3W-27K-R24D-WH-W-LS-ELV-H3-NC

























SERIES	SIZE	TRIM		WATAGE	CCT	BEAM ANGLE		FINISH									
		M35 Options	M35 Trim Option			Reflector Lens	OR	TIR Lens	Reflector	Trim							
Go2 Mini	M35 1.5"	BEV	Bevel	STD	Standard	3W	240lm	27K	2700K	R24D	24 Degree	T24D	24 Degree	WH	White	W	White
		BULL	Bullnose	NRW	Narrow Trim	5W	400lm	30K	3000K	R36D	36 Degree	T36D	36 Degree	BL	Black	B	Black
		PNH	Pinhole	WDT	Wide Trim	7W	560lm	35K	3500K			T50D	50 Degree	SV	Silver	RAL#	Custom
		SNT	Snoot	RDL	RD Trimless			40K	4000K					SP	Specular		
				SQL	SQ Trimless			TW	Tunable White 2700K-6500K					SB	Specular Black		
		SQT	SQ Trimmedv									SG	Specular Gold				

OPTICAL ACCESSORIES	DIMMING	HEAD CONFIGURATION *	INSTALLATION TYPE	EMERGENCY BACKUP
No Lens (leave blank) HL Hexcell Louver LS Linear Spread	ELV Phase/Triac(3%) DIO 0-10V(.1%)	H1 Single Head (1 Driver / 1 Luminaire) H2 2 Heads Cluster (1 Driver / 2 Luminaires) H3 3 Heads Cluster (1 Driver / 3 Luminaires) H4 4 Heads Cluster (1 Driver / 4 Luminaires) H5 5 Heads Cluster (1 Driver / 5 Luminaires)	NC New Construction Tray RM Remodel (no NCTray)	EM10 10W/90 Min

*One driver can power multiple Go2 Mini heads in a cluster.
The appropriate driver output will be determined and supplied by the factory according to the combined luminaire load.*

Project: _____ Type: _____ Qty: _____

TRIM OPTIONS

	Narrow Trim (NRW)	Wide Trim (WDT)	Trimless (RDL)	Trimless (SQL)	Square (SQT)
 <p>Bevel</p>					
 <p>Pinhole</p>					
 <p>Snoot</p>					
 <p>Bullnose</p>					

Project:	Type:	Qty:
----------	-------	------

REFLECTOR OPTIONS



White



Black



Silver



Specular



Black Specular



Gold

PERFORMANCE

90 CRI / 3000K	15 Degree	24 Degree	38 Degree	50 Degree
3W	198Lm	221Lm	225Lm	203Lm
5W	330Lm	368Lm	375Lm	338Lm
7W	462Lm	515Lm	525Lm	473Lm

Preliminary, pre-launch test-data. Delivered lumen values +/- 5%. Optical filters will reduce delivered lumen values

Project:	Type:	Qty:
----------	-------	------

MOUNTING OPTIONS

NC - New Construction Frame-In Tray

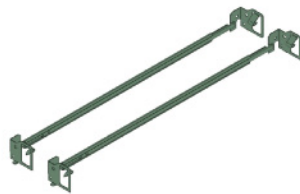
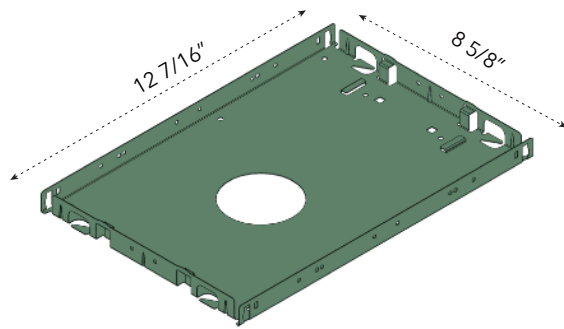

Standard bar hanger (included)

Mounting Length 14 3/4" - 26".
Extension kit can be ordered separately.

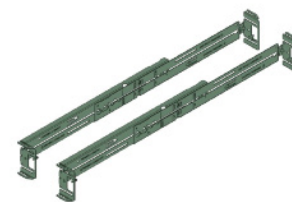

Commercial bar hanger #1487

Butterfly and Caterpillar brackets available



New Construction & Remodel Mounting

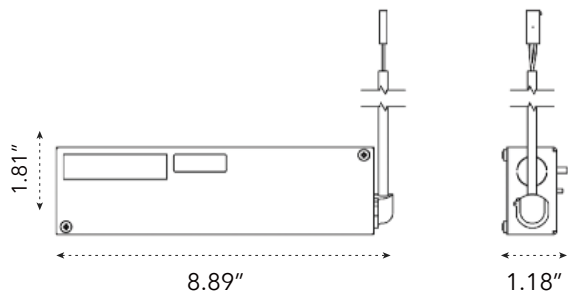

Due to the small aperture size, all drivers will need to be remotely located within 50" of the fixtures and installed in a location that is accessible without the need for demolition. Each driver will ship in an individual driver enclosure box. However, it is not recommended to stack the driverboxes on top of each other as there is a potential for overheating.

Project: _____ Type: _____ Qty: _____

EMERGENCY

PRIMARY SPECIFICATIONS

Output Power Max	Input Power	Input Current Max	Emergency Operating Time	Battery	Input Voltage	Output Voltage	Ambient Operating Temperature	UL Listed for Us and Canada
10W	4W	100 mA	90 min.	Li-ion 18650 7.4V 2500mAh	120-277 Vac 50/60Hz	12-55 VDC	0 °C through 55 °C	ULand cUL (UL924) Emergency LED Driver

Dimensions / Weight

Length	12.4"	Height	1.1"
Width	1.77"	Mounting Length	11.88"
Weight	2.47 lb		

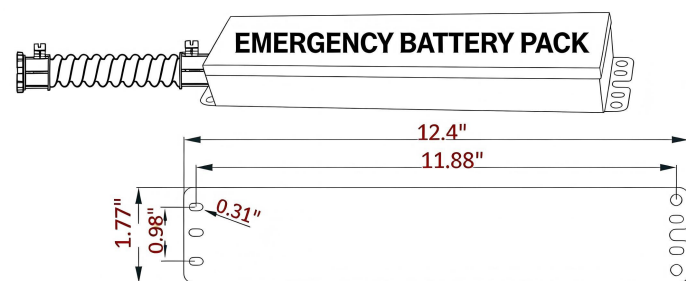

REMOTE TEST SWITCH

The remote test switch may be mounted adjacent to the LED fixture by others.

EMERGENCY BATTERY ACCESS

Above ceiling access is recommended for ease of service, but LED fixture sizes of 4" and larger are capable of below ceiling access. IC/ICAT/CP box and ITS option require an access panel in the ceiling (or other form of access) adjacent to the installation location of the emergency battery.

REMOTE LOCATION

Maximum remote mounting distance of the emergency driver shall be 50 feet. Remote location wiring provided by others. Follow all local and national electric/building codes.

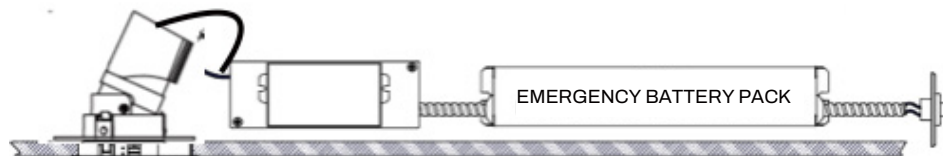

WALL PLATE ACCESSORIES

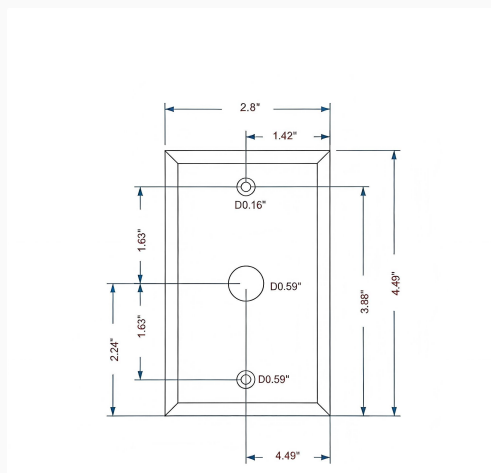

TEST SWITCH

