

Project:	Type:	Qty:
----------	-------	------

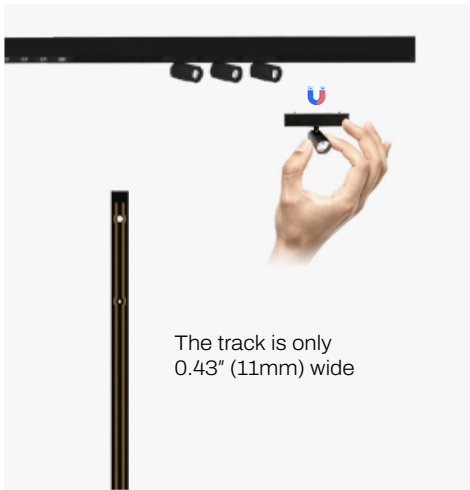

The track is only 0.43" (11mm) wide



FEATURES

ELF is a miniature 48V magnetic track system. Its small size allows it to be installed anywhere.

ELF is perfect for applications such as; retail and jewelry displays, museum exhibition, library cases, wardrobe, wine racks and any place where a discrete profile is desired.

Wide selection of luminaires available (see luminaire spec sheet).

Track is field cuttable.

Available in recessed, surface and suspended mounting options.

Profile is offered in both round and square options.

Track is very versatile, it can be curved, squared, or angled into many shapes.

ORDER CODE

ORDER CODE EXAMPLE: ELF-TT-P-W-PTR-AC#-SM-WH

SERIES	FRONT COVER	MOUNTING	APPLICATION	SHAPE	CORNERS
ELF	SS1 Slim Square SR2 Slim Round TT Tall Track RC Recessed Slim RT Recessed Tall	P Pendant R Recessed S Surface	C Ceiling W Wall W2C Wall to Ceiling	STR Straight PTR Pattern SQR Square RND Round	RC# Radius Corner AC# Angled Corners Specify the radius or angle of the corner. Leave blank if straight run or a ring. Ex. RC90-90 degree corner

MOUNTING	OVERALL LENGTH	FINISH
SM Stem Mounted #_2" / 4.5" / 12.5" AC Suspended w/ Ac Cable #_Specify Length	___" Straight Run ___" Diameter ___" X ___" X ___" X Square or Pattern Drawings will be required for all pattern runs	BK Black WH White RAL RAL#

Specify this section only when incorporating layers into the track design

LAYERS	TRACK	SHAPE	CORNERS	OVERALL LENGTH	FINISH
L2 Second Layer L3 Third Layer	SS1 Slim Square SR2 Slim Round TT Tall Track	STR Slim Square PTR Slim Round SQR Square SQR Round	RC# Radius Corner AC# Angled Corners Specify the radius or angle of the corner. Leave blank if straight run or a ring. Ex. RC90-90 degree corner	___" Straight Run ___" Diameter ___" X ___" X ___" X Square or Pattern Drawings will be required for all pattern runs	BK Black WH White RAL RAL#

Factory will be responsible for determining number of power boxes, drivers, connectors, corners and other accessories needed (based on client's design intent). Please provide RCP and drawings showing full detail of runs.

Project: _____ Type: _____ Qty: _____

SPOT LUMINAIRES

Spots

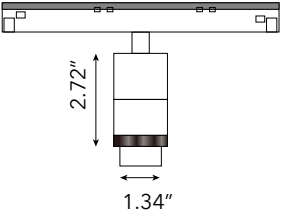
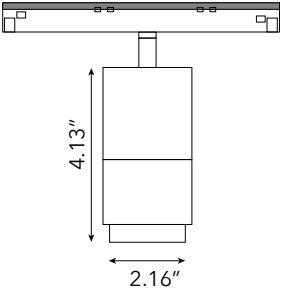
  <p>E-13 5W (370LM)</p>	  <p>E-Z20 3W (180LM)</p>	  <p>E-Z35 5W (280LM)</p>	  <p>E-Z55 15W (1055LM)</p>	  <p>E-20 3W (186LM)</p>
  <p>E-35 5W (440LM)</p>	  <p>E-45 10W (745LM)</p>	  <p>E-55 15W (1186LM)</p>	  <p>E-TR 10W (700LM)</p>	  <p>E-TS 10W (700LM)</p>

ORDER CODE ORDER CODE EXAMPLE: E35-48V-90-30K-Z-D10-WH-HC

MODEL	VOLTAGE	CRI	CCT	BEAM	DIMMING
___ Specify Model #	48V 48VDC	90 90Ra	27K 2700K 30K 3000K 35K 3500K 40K 4000K TW Tunable White 2700K-6500K WD Warm Dim 3000K-1800K	Z Zoomable Lens ___ 15D/24D/36D	D10 0-10V DALI DALI WLS Wireless / Bluetooth

FINISH	ACCESSORY
WH White BK Black RAL Custom RAL	HC Honeycomb Black LS Linear Spread

Custom wattages are available
 Tunable White Warm-3000K-1800K
 Tunable White Cool-6000K-3500K

In an effort to offer the best product possible, we reserve the right to change, without notice, specification or material of the product.

✉ info@binacompany.com
 ☎ 305.735.3114
 🌐 www.binacompany.com



Project:	Type:	Qty:
----------	-------	------

TRACK

Linear Baffle

SS1
Square Slim Track
- Surface & Pendant Mount

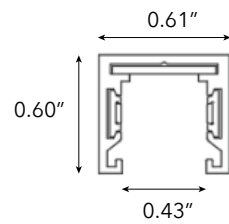
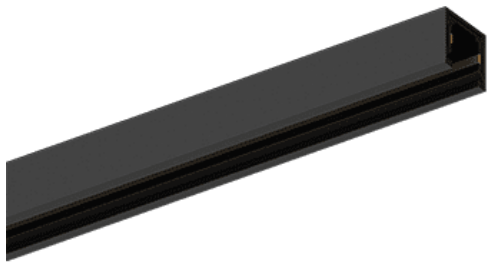

RC
Slim Track
- Recessed

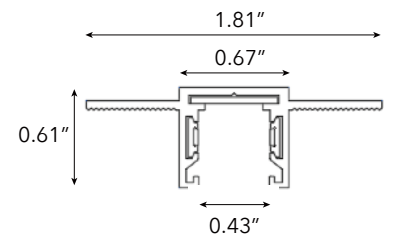

SR2
Round Slim Track
- Surface & Pendant Mount

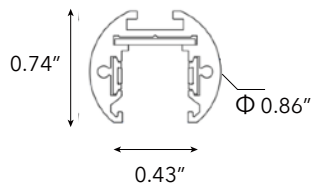

RT
Tall Track Recessed

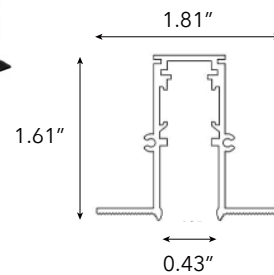

TT
Tall Track - Surface & Pendant Mount

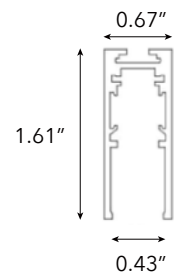

Rings and Radius Corners

For rings and radius corners, specify radius or diameter.



Project: _____ Type: _____ Qty: _____

LUMINAIRES

<p>E-F10 10W (600LM)</p>	<p>E-F15 15W (900LM)</p>	<p>E-G10 10W (600LM)</p>	<p>E-G15 15W (900LM)</p>
<p>E-FF10 10W (600LM)</p>	<p>E-FF15 15W (900LM)</p>	<p>E-FG10 10W (600LM)</p>	<p>E-FG15 15W (900LM)</p>

ORDER CODE ORDER CODE EXAMPLE: EFF15-48V-90-30K-20D-D10-WH

MODEL	VOLTAGE	CRI	CCT	BEAM	DIMMING	FINISH
____ Specify Model #	48V 48VDC	90 90Ra	27K 2700K 30K 3000K 35K 3500K 40K 4000K TW Tunable White 2700K-6500K WD Warm Dim 3000K-1800K	____ 20D/30D (Eclipse Only)	D10 0-10V DALI DALI WLS Wireless / Bluetooth	WH White BK Black RAL RAL#

Project: _____ Type: _____ Qty: _____

SPECIALTY LUMINAIRES

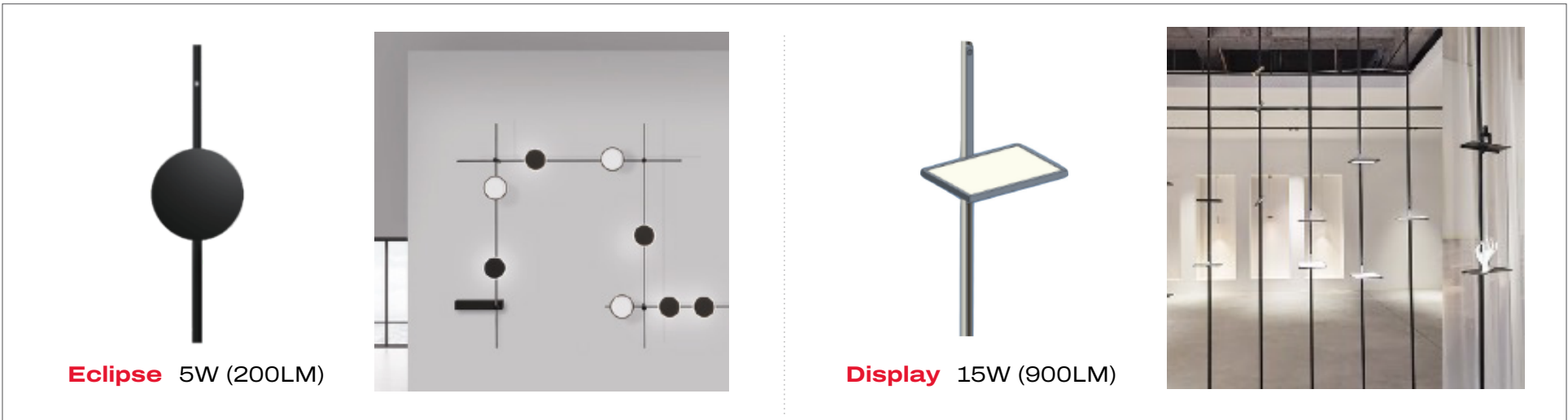

ORDER CODE

ORDER CODE EXAMPLE: ECLIPSE-48V-90-30K-20D-D10-WH

MODEL	VOLTAGE	CRI	CCT	BEAM	DIMMING	FINISH
____ Specify Model #	48V 48VDC	90 90Ra	27K 2700K 30K 3000K 35K 3500K 40K 4000K TW Tunable White 2700K-6500K WD Warm Dim 3000K-1800K	____ 20D/30D (Eclipse Only)	D10 0-10V DALI DALI WLS Wireless / Bluetooth	WH White BK Black RAL RAL#

CONNECTORS

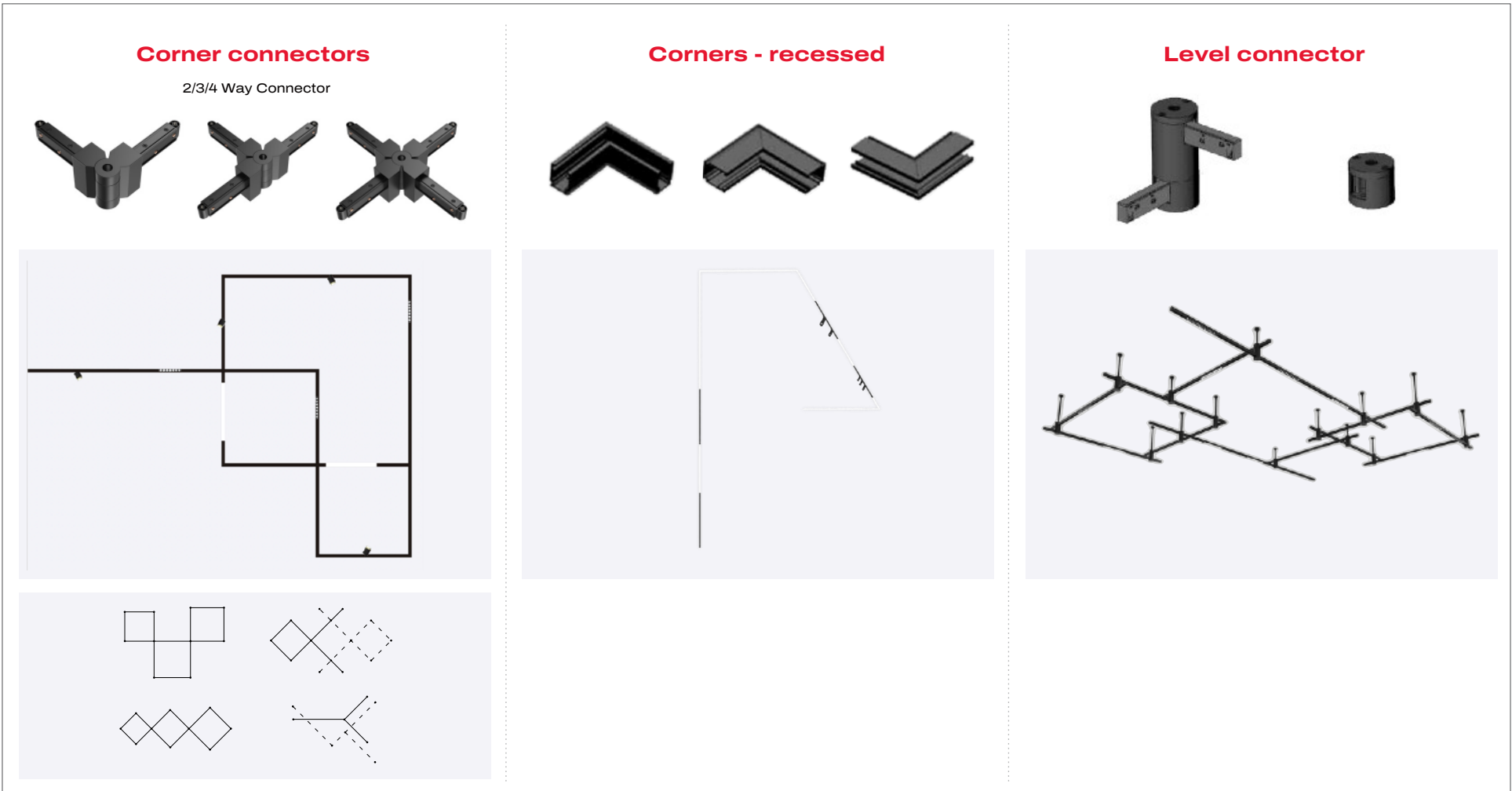





All power, mounting, connectors and accessories for proper assembly will be determined by the factory.

In an effort to offer the best product possible, we reserve the right to change, without notice, specification or material of the product.

Project:	Type:	Qty:
----------	-------	------

Power,connectors and conductors

Accessories are included and supplied with the order. No separate purchase is required.

<p>ELF-PB01 power feeder with 5ft wire</p> 	<p>ELF-PB01 power feeder with 5ft wire</p> 	<p>I connector</p> 
<p>ELF-PB03 Doubled head power connector</p> 	 <p>Suspension Cable/Stem custom length</p>	 <p>LC-L 90D corner IC- Inner corner</p> <p>OC- outer corner</p>

Power Supply- Order separately

Drivers used for power
60W/ 96W/ 100W/ 150W/ 200W/ 288W/ 300W/384W options
Order code:
NON dim: NDP-(volt age)-(power), example: NDP-48V-100W
DIM: HZA-(volt age)-(power), exmple: NDP-48V-200W

Driver and Dimmer Int egrat ed
Available in 60W / 96W / 160W
Order Code: SDD-(Volt age)-(Power)-DIM, example: SDD-48v-60W-DIM

