



**Dyke Industries, Inc.**



## INTERIOR DOOR GUIDE

Building Quality Doors Since 1866

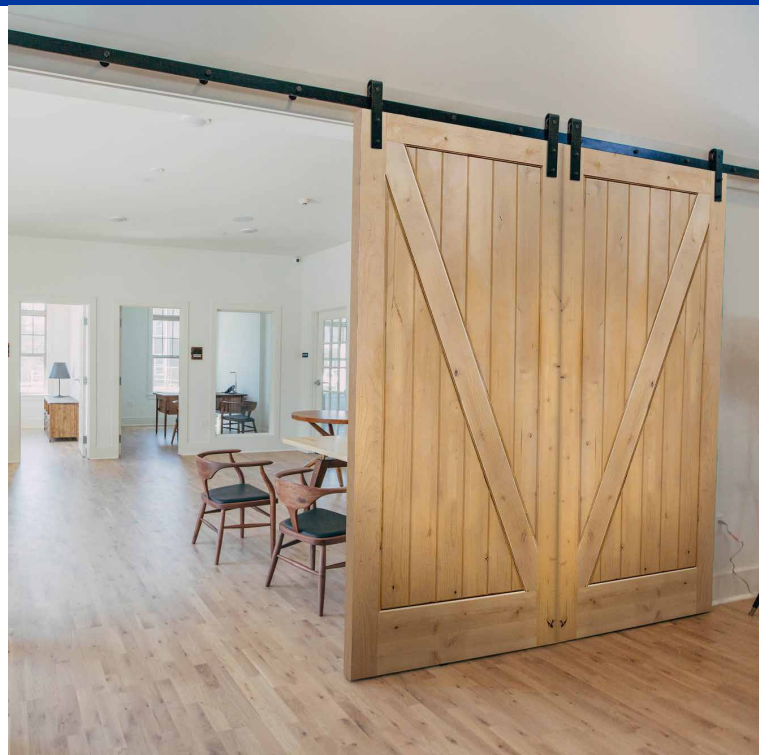
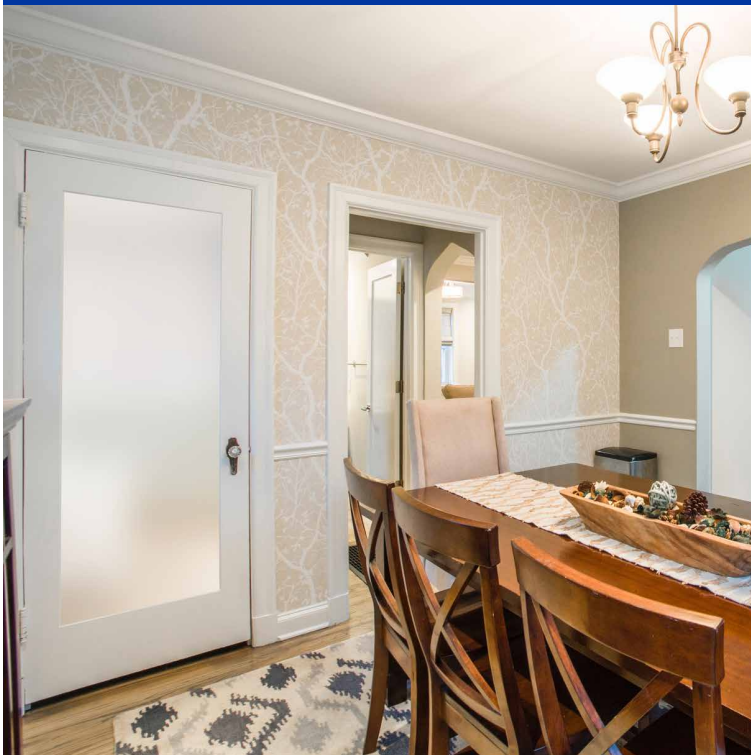

# Dyke Industries History

Dyke Industries is a privately held company which has been in business since 1866. Dyke Industries, Inc. is the corporate successor to two millwork manufacturing companies, Dyke Bros., established in Fort Smith, Arkansas in 1870, and Cole Manufacturing Company, established in Memphis, Tennessee 1866. The company in its present form was incorporated in 1942.

Our 15 distribution outlets are strategically located providing 18 states with a broad line of residential and commercial building materials including interior and exterior doors, millwork, and windows. Dyke has always been a forerunner in the millwork industry because of the belief in service, quality, and stability.

Our mission statement is clear: To be the leader in the markets we service by delivering a quality product at a competitive price on time and complete.



# Make your House a Dream Home with Dyke Doors

---

## Select Your Interior Door Style



### **MOLDED PANEL**

Molded panel doors resist shrinking, swelling, cracking and splitting. Available in a wide variety of sizes, they can be painted or stained to match any décor. *(See pages 2-5)*



### **FLUSH DOORS**

Flush doors give your home the beautiful wood detail you're looking for and can be painted or stained to match your existing furnishings. Available in several natural wood finishes and variety of sizes, these doors can be made to fit your home perfectly. *(See pages 6-7)*



### **BI-FOLD DOORS**

Bi-fold doors save space while achieving the appearance you desire. Bi-folds are available in the same styles and finishes as molded panel and flush doors, and can be made to fit any room in your home. *(See pages 8-11)*



### **WOOD STILE AND RAIL**

Wood panel doors with true stile and rail construction help dress your home up or keep it casual. Available in multiple styles and species, these doors give your home a natural feel. *(See pages 12-15)*



### **PRIMED**

Primed doors are assembled by hand and manufactured to exact specifications. These doors offer sound reduction in multiple design options to match your home's style. *(See pages 16-17)*



### **BARNDOORS**

*(See page 18-19)*



### **DOOR HARDWARE**

*(See page 21)*

### **BARN DOOR HARDWARE**

*(See page 22)*

### **JAMBS, CASING, STOPS, AND HINGES**

*(See page 23)*



### **DOOR DETAILS, HANDINGS, ROUGH OPENING AND DOOR INSTALLATION TIPS**

*(See page 24)*

# MOLDED PANEL



Solid Core

Hollow Core

## LONG-LASTING BEAUTY

When you install a Dyke Industries molded panel door, you'll know that the perfect fit will stay the perfect fit -- because these doors resist shrinking, swelling, cracking or splitting. The smooth or textured surface can be painted to match any décor, delivering eye-catching beauty for years to come.

- Available in various panel designs.
- Most designs are available in smooth surfaces. Select designs are available in textured surfaces
- Varying designs - round top, square top and more - help ensure a match to any style
- Available in hollow core, solid particle board, and fire rated







1 - 3/8"				1 - 3/4"
HC	SC	HC	SC	SC 20min Fire Rated
1068	1068	1680	1680	
1268	1268	2080	2080	2868
1368	1368	2280	2280	3068
1468	1468	2480	2480	3080
1668	1668	2680	2680	
1868	1868	2880	2880	
11068	11068	21080	21080	
2068	2068	3080	3080	
2468	2468			
2668	2668			
2868	2868			
21068	21068			
3068	3068			

**Madison**  
SMOOTH  
SQUARE

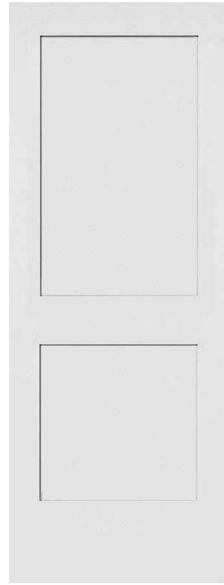

1 - 3/8"				1 - 3/4"
HC	SC	HC	SC	SC 20min Fire Rated
1068	1068	2080	2080	
1268	1268	2480	2480	3068
1368	1368	2680	2680	3080
1468	1468	2880	21080	
1668	1668	21080	3080	
1868	1868	3080		
11068	11068			
2068	2068			
2268	2268			
2468	2468			
2668	2668			
2868	2868			
21068	21068			
3068	3068			

**Monroe**  
SMOOTH  
SQUARE

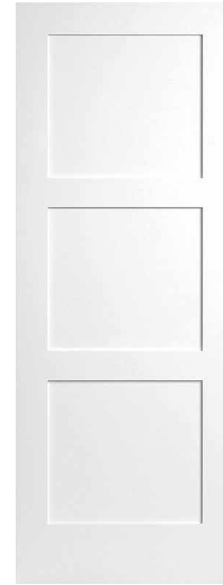

1 - 3/8"		1 - 3/4"
HC	SC	20 Min Fire Rated
1468	1668	
1668	2068	2868
2068	2468	3068
2468	2668	
2668	2868	
2868	3068	
3068		

**Birkdale**  
SMOOTH  
SQUARE

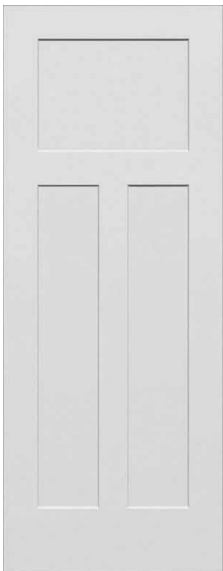

1 - 3/8"		1 - 3/4"
HC	SC	20 Min Fire Rated
1068	1068	
1268	1268	2868
1368	1368	3068
1468	1468	
1668	1668	
1868	1868	
11068	11068	
2068	2068	
2268	2268	
2468	2468	
2668	2668	
2868	2868	
21068	21068	
3068	3068	

**Craftsman**  
SMOOTH  
SQUARE



1 - 3/8"		1 - 3/4"
HC	SC	20 Min Fire Rated
1068	1068	
1268	1268	2868
1368	1368	3068
1468	1468	
1668	1668	
1868	1868	
11068	11068	
2068	2068	
2268	2468	
2468	2668	
2668	2868	
2868	21068	
21068	3068	
3068		

**Conmore**  
SMOOTH  
STEPPED STICKING

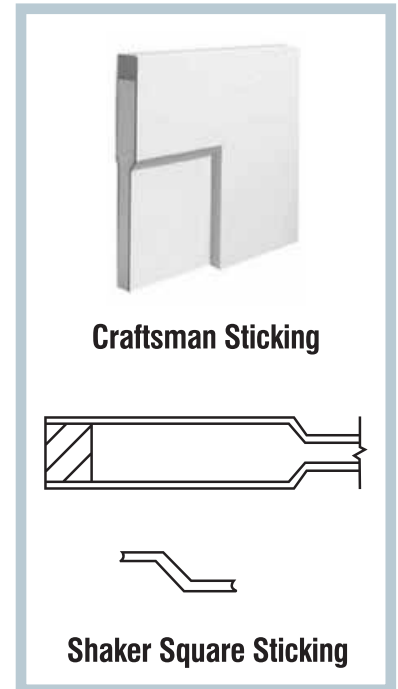

Available Fire Rated



**Carrara**  
SMOOTH  
COVE AND BEAD

1 - 3/8"					1 - 3/4"
HC	SC	SC	SC	HC	SC 20min Fire Rated
1068	1068	3070	1680	1680	
1268	1268		2080	2080	2868
1368	1368		2480	2280	2880
1468	1468		2680	2480	3068
1667	1668		2880	2880	3080
1668	1868		3080	21080	
1868	11068			3080	
11068	2068				
2067	2268				
2068	2468				
2268	2668				
2467	2868				
2468	21068				
2667	3068				
2668					
2867					
2868					
21067					
21068					
21070					
3067					
3068					
3070					



**Camden**  
TEXTURED  
COVE AND BEAD

1 - 3/8"		1 - 3/4"
HC	SC	SC 20min Fire Rated
1068	1068	
1268	1268	2868
1368	1368	3068
1468	1468	
1668	1668	
1868	1868	
11068	11068	
2068	2068	
2268	2268	
2468	2468	
2668	2668	
2868	2868	
21068	21068	
3068	3068	



**Caiman**  
SMOOTH  
COVE AND BEAD

1 - 3/8"			1 - 3/4"
HC	SC	SC	SC 20min Fire Rated
1068	1068	1680	
1268	1268	2080	2868
1368	1368	2480	2880
1468	1468	2680	3068
1668	1668	2880	3080
1868	1868	3080	
11068	11068		
2068	2068		
2268	2268		
2468	2468		
2668	2668		
2868	2868		
21068	21068		
3068	3068		



**Santa Fe**  
SMOOTH  
OVOLO

1 - 3/8"		1 - 3/4"
HC	SC	SC 20min Fire Rated
1068	1068	
1268	1268	2868
1368	1368	3068
1468	1468	
1668	1668	
1868	1868	
11068	11068	
2068	2068	
2268	2268	
2468	2468	
2668	2668	
2868	2868	
21068	21068	
3068	3068	





1 - 3/8"	
HC	SC
11068	11068
2068	2068
2268	2268
2468	2468
2668	2668
2868	2868
21068	21068
3068	3068

**Coventry**  
SMOOTH  
COVE AND BEAD



1 - 3/8"			1 - 3/4"
HC	SC	HC	SC 20min Fire Rated
1068	1068	1680	
1268	1268	2080	2868
1368	1368	2480	3068
1468	1468	2680	
1668	1668	2880	
1868	1868	21080	
11068	11068	3080	
2068	2068		
2268	2268		
2468	2468		
2668	2668		
2868	2868		
21068	21068		
3068	3068		

**Rockport**  
SMOOTH  
COVE AND BEAD



1 - 3/8"		
HC	SC	SC 20min Fire Rated
1068	1068	2868
1268	1268	3068
1368	1368	
1468	1468	
1668	1668	
1868	1868	
11068	11068	
2068	2068	
2268	2268	
2468	2468	
2668	2668	
2868	2868	
21068	21068	
3068	3068	

**Colonist**  
SMOOTH & TEXTURED  
COVE AND BEAD

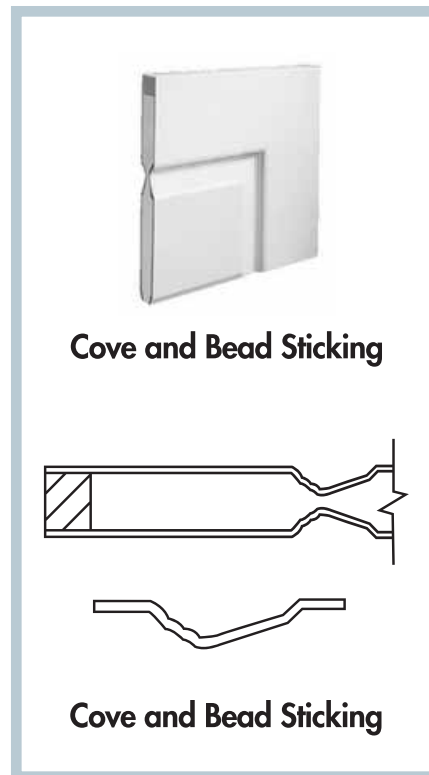

# FLUSH DOORS



## THE LOOK, FEEL AND SOUND OF WOOD

Wood is beautiful, but solid wood doors aren't always the best choice for everyone. Fortunately, flush doors from Dyke Industries provide the beauty, feel, and sound of wood, making flush doors an excellent option. With a rich look and three types of wood grains - including birch, oak, and lauan - you'll find the perfect choice for any décor.

- Available in multiple wood species including stocked oak, birch, and hardboard
- Available in hollow core, solid particle board core and fire-rated core
- Most designs available in matching bi-fold doors







**Birch**

1 - 3/8"		1 - 3/4"
HC	SC	SC 20min Fire Rated
1068	2068	2668
1268	2468	2868
1368	2668	21068
1468	2868	3068
1668	21068	2870
1868	3068	3070
11068	3070	
2068		
2268		
2468		
2668		
2868		
21068		
3068		



**Red Oak**

1 - 3/4"
SC 20min Fire Rated
3068
3070

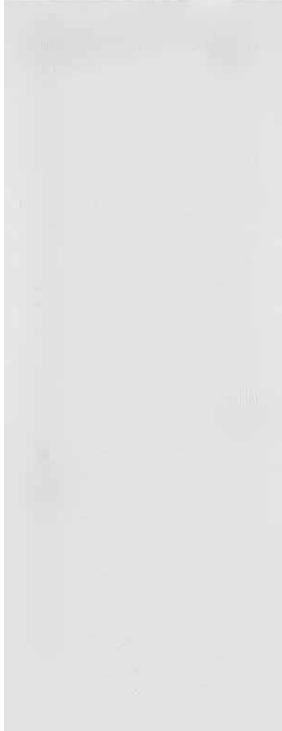

**Primed Hardboard  
SMOOTH**

1 - 3/8"		
HC	SC	SC
1668	1668	1670
2068	2068	2070
2468	2468	2470
2668	2668	2670
2868	2868	2870
21068	21068	21070
3068	3068	3070

1 - 3/4"		
HC	SC	SC 20min Fire Rated
3067	3067	3067
30711	30711	30711

# BI-FOLD DOORS

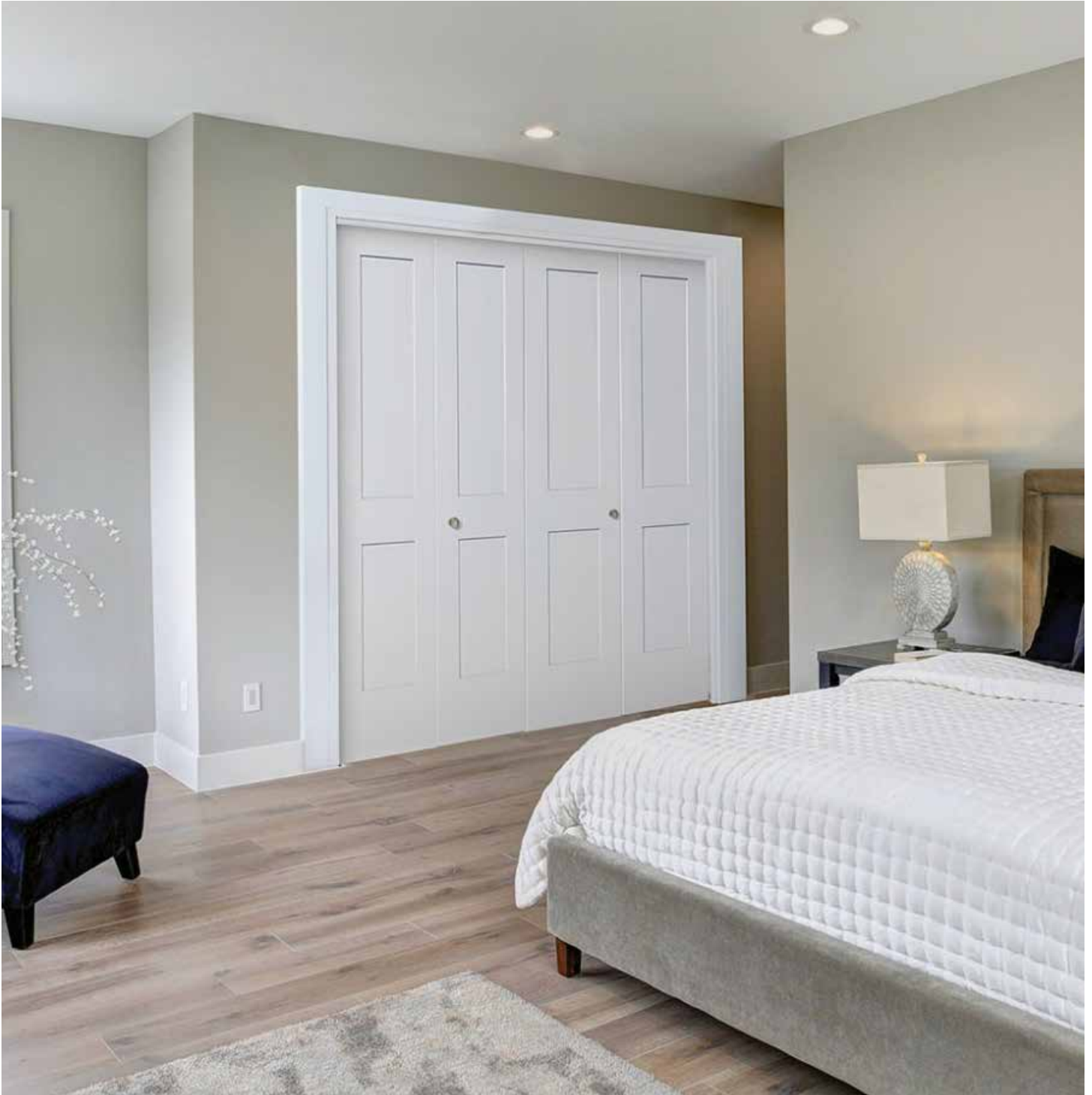

## SPACE - SAVING CHARM IN ANY ROOM

Bi-fold doors save space while delivering an attractive style. Bi-folds are available in the same designs as our molded panel and flush doors, all with the quality you expect from Dyke Industries.





1 - 1/8"
4/0
5/0
6/0

**Madison**  
SMOOTH



1 - 1/8"
4/0
5/0
6/0

**Monroe**  
SMOOTH



1 - 1/8"
4/0
5/0
6/0

**Birkdale**  
SMOOTH



1 - 1/8"
4/0
5/0
6/0

**Craftsman**  
SMOOTH



1 - 1/8"
4/0
5/0
6/0

**Conmore**  
SMOOTH

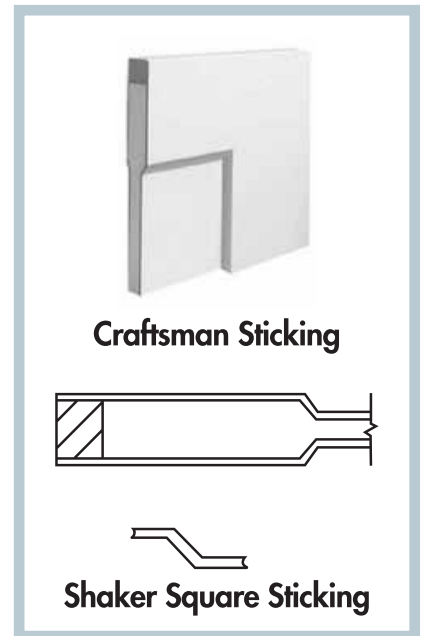

\*2/0, 2/6, 3/0 sizes available



1 - 1/8"
4/0
5/0
6/0

**Carrara and Coventry**  
SMOOTH



1 - 1/8"
4/0
5/0
6/0

**Camden**  
TEXTURED



1 - 1/8"
4/0
5/0
6/0

**Caiman**  
SMOOTH



1 - 1/8"
4/0
5/0
6/0

**Santa Fe**  
SMOOTH



1 - 1/8"
4/0
5/0
6/0

**Louver Over Louver**  
SMOOTH



1 - 1/8"
4/0
5/0
6/0

**Rockport**  
SMOOTH



**\*2/0, 2/6, 3/0 sizes available**





1 - 1/8"
4/0
5/0
6/0

**Colonist**  
SMOOTH & TEXTURED



1 - 3/8"
4/0
5/0
6/0

**Birch**



1 - 1/8"
4/0
5/0
6/0

**Louver Over Louver Pine**



1 - 1/8"
4/0
5/0
6/0

**6 Panel Pine**

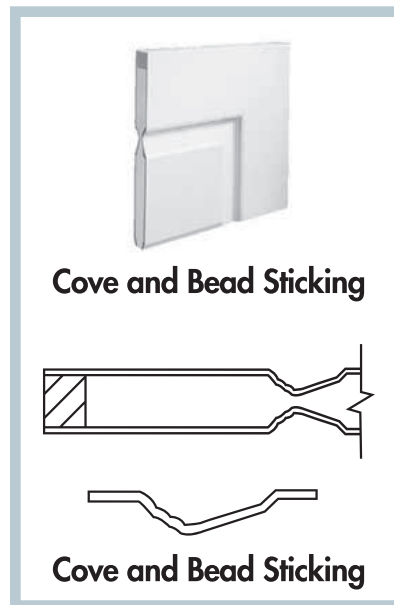

**\*2/0, 2/6, 3/0 sizes available**

# WOOD STILE AND RAIL



## NATURAL QUALITY, NATURAL BEAUTY

The charm and quality of true stile and rail construction blend perfectly in Dyke Industries' wood panel doors. These finely crafted doors offer excellent sound reduction and lasting beauty. Available in multiple species and various styles, these doors are ready to accept stain, paint or clear finish that will match your home's décor.

- Solid core stile and rail construction provides outstanding sound reduction
- Built for long-lasting beauty





1 - 3/8"
2670
2870
3070
3470

**1 Panel Knotty Pine**  
SHAKER



1 - 3/8"
1468
1668
1868
2068
2268
2468
2668
2868
21068
3068

**6 Panel Pine**  
OVOLO



1 - 3/8"
1668
2068
2468
2668
2868
3068

**6 Panel Poplar**  
OVOLO



1 - 3/8"
1668
2068
2468
2668
2868
3068

**6 Panel Red Oak**  
OVOLO



1 - 3/8"
1668
2068
2468
2668
2868
21068
3068

**Full Louver Pine**  
SMOOTH



1 - 3/8"  
2068

**Pine 10 Lite Clear**  
OVOLO



1 - 3/8"  
2668  
2868  
3068

**Pine 15 Lite Clear**  
OVOLO



1 - 3/8"  
2068

**Poplar 10 Lite Clear**  
OVOLO



1 - 3/8"  
2668  
3068

**Poplar 15 Lite Clear**  
OVOLO







1 - 3/8"
2068
2468
2668
2868
3068

**Pine 1 Lite Frosted**  
OVOLO



1 - 3/8"
2068
2468
2668
2868
3068

**Pine 1 Lite Clear**  
OVOLO



1 - 3/8"
2068
2468
2668
2868
3068

**Pine Pantry**  
OVOLO

# PRIMED



## SMOOTH AND DURABLE

You could sand wood all day and never make it feel as smooth as the finish on a Dyke Primed door. Assembled by hand and manufactured to exact specifications with a high density core to provide sound reduction, the Primed doors offer the weight and feel of solid wood, with a blend of craftsmanship to resemble true stile and rail construction. The wide range of designs and the primed finish give you the options to match the style of any home.





1 - 3/8"  
1668

**5 Lite Clear**  
OVOLO

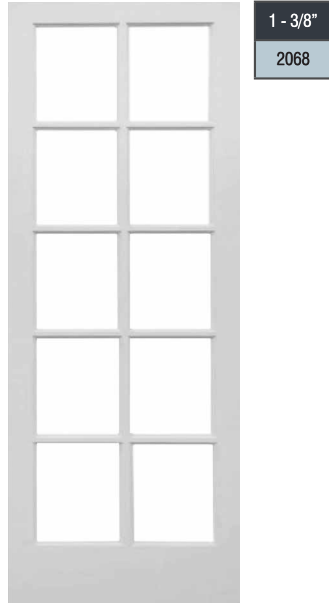

1 - 3/8"  
2068

**10 Lite Clear**  
OVOLO

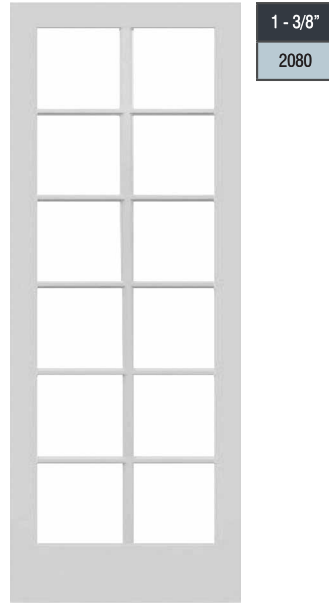

1 - 3/8"  
2080

**12 Lite Clear**  
OVOLO

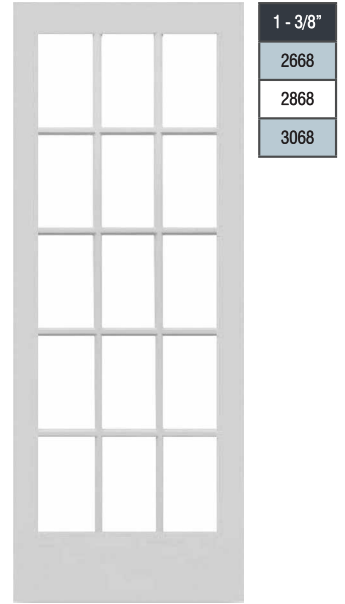

1 - 3/8"  
2668  
2868  
3068

**15 Lite Clear**  
OVOLO

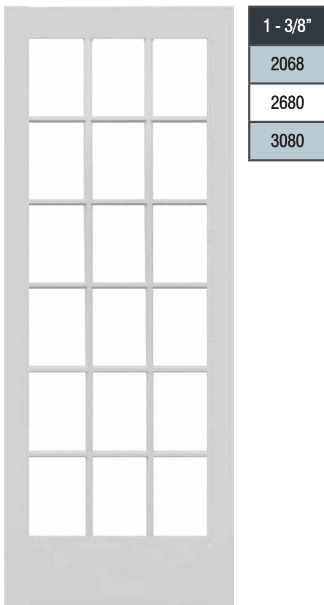

1 - 3/8"  
2068  
2680  
3080

**18 Lite Clear**  
OVOLO

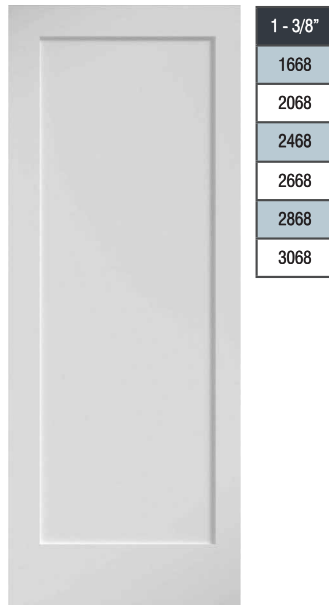

1 - 3/8"  
1668  
2068  
2468  
2668  
2868  
3068

**1 Panel**  
SHAKER

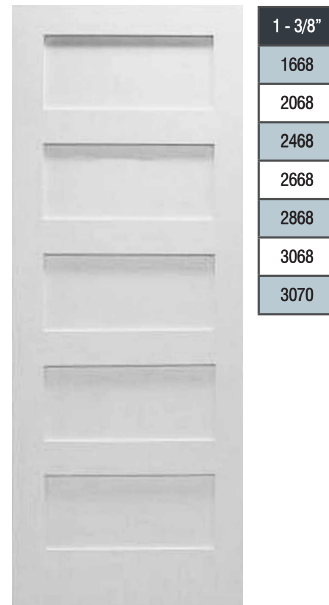

1 - 3/8"  
1668  
2068  
2468  
2668  
2868  
3068  
3070

**5 Panel Equal**  
SHAKER

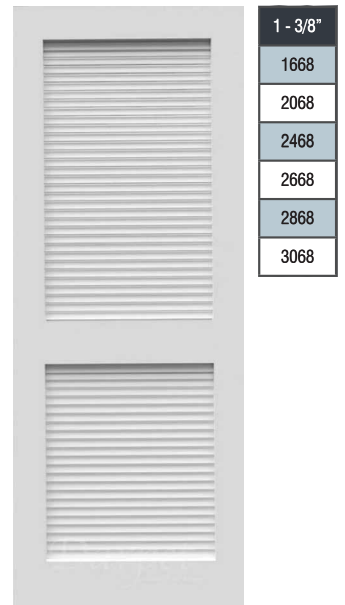

1 - 3/8"  
1668  
2068  
2468  
2668  
2868  
3068

**Full Louver**  
SHAKER

# BARNDOORS







Knotty Pine
2670
2870
3070
2470

DI 01



Knotty Pine
2670
2870
3070
2470

DI 02



Knotty Pine
2670
2870
3070
2470

DI 03



Knotty Pine
2670
2870
3070
2470

DI 04



Knotty Pine
2670
2870
3070
2470

DI 05



Knotty Pine
2670
2870
3070
2470

DI 06



Knotty Pine
2670
2870
3070
2470

DI 07



Knotty Pine
2670
2870
3070
2470

DI 07R

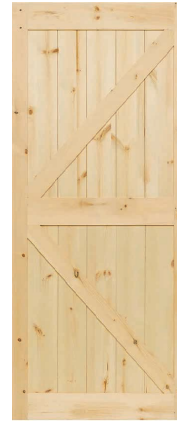

Knotty Pine
2670
2870
3070
2470

DI 08



Knotty Pine
2670
2870
3070
2470

DI 08R



Knotty Pine
2670
2870
3070
2470

DI 09



Knotty Pine
2670
2870
3070
2470

DI 10



Knotty Pine
2670
2870
3070
2470

DI 11



Knotty Pine
2670
2870
3070
2470

DI 11R



Knotty Pine
2670
2870
3070
2470

DI 12

Full panels are stock, custom SDL's call for lead time.

# STILE & RAIL CUSTOM SDL

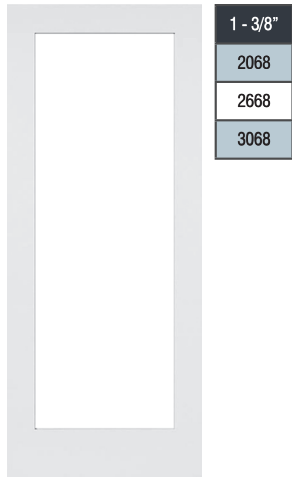

1 - 3/8"
2068
2668
3068

**1 Lite Clear**  
OVOLO

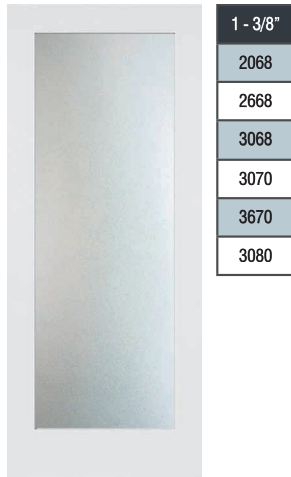

1 - 3/8"
2068
2668
3068
3070
3670
3080

**1 Lite Frosted**  
OVOLO

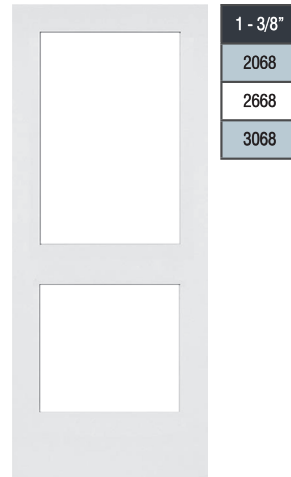

1 - 3/8"
2068
2668
3068

**Monroe Clear**  
SQUARE

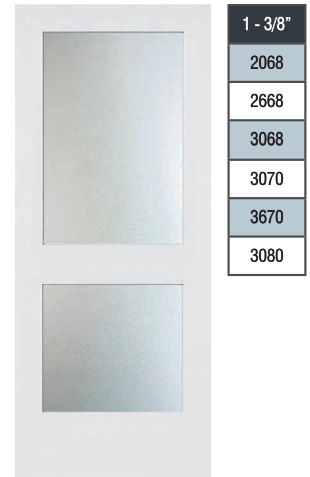

1 - 3/8"
2068
2668
3068
3070
3670
3080

**Monroe Frosted**  
SQUARE

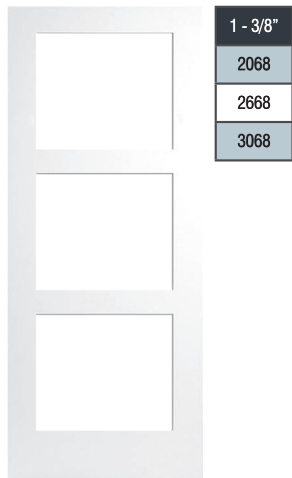

1 - 3/8"
2068
2668
3068

**Birkdale Clear**  
SQUARE

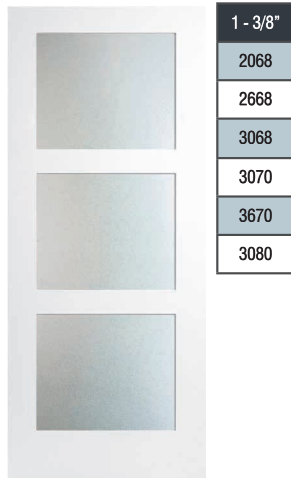

1 - 3/8"
2068
2668
3068
3070
3670
3080

**Birkdale Frosted**  
SQUARE

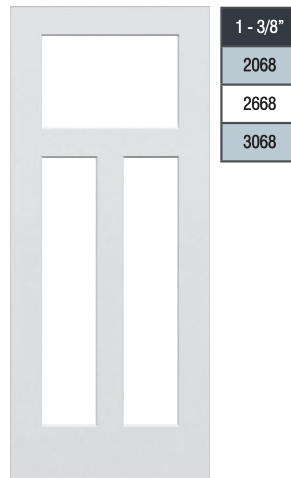

1 - 3/8"
2068
2668
3068

**Craftsman Clear**  
SQUARE

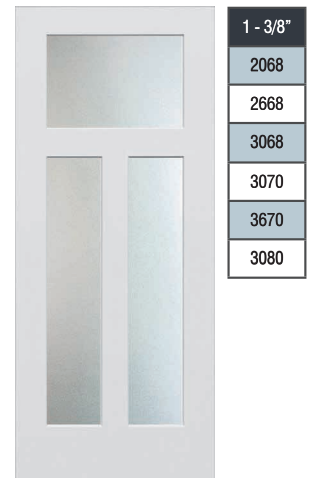

1 - 3/8"
2068
2668
3068
3070
3670
3080

**Craftsman Frosted**  
SQUARE

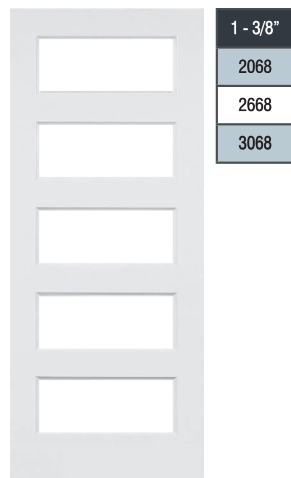

1 - 3/8"
2068
2668
3068

**Conmore Clear**  
SQUARE

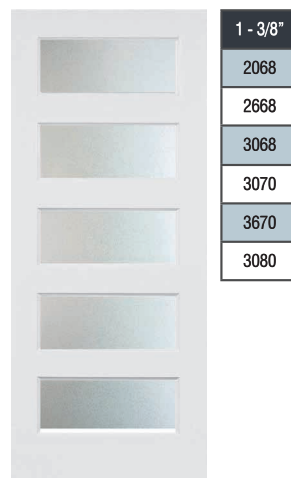

1 - 3/8"
2068
2668
3068
3070
3670
3080

**Conmore Frosted**  
SQUARE



Full lites are stock, custom SDL's call for lead time.

# HARDWARE

## Pocket Door Frames

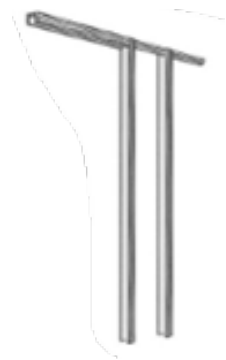

ROUGH OPENING FOR K.D. BOXED FRAME	
PDF2868	PDF2068
PDF2880	PDF2080
PDF3068	PDF2468
PDF3080	PDF2480
	PDF2668
	PDF2680

### Unassembled boxed unit

Easy to store and handle, carton packaged  
 Available in sizes up to 3068 and 3080 (universal frame and hardware)  
 1-3/8" or 1-3/4" width doors and up to 125 pounds.  
 Reinforced frame with steel stiffener  
 Cut marks make easy sizing to standardized door widths  
 Jump proof track due to 4 wheeled roller and V-groove track system



**Strike Plate**

SPAB
SPBB
SPSN
SPSC
SPBC
SPORB

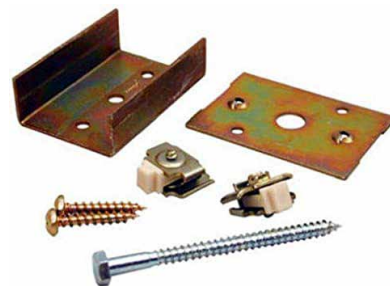

**Pocket Door Converging Kit**



4/0
5/0
6/0

**#2200 Aluminum Track and Hardware**



4/0
5/0
6/0

**#2200F Aluminum Track and Hardware**



**Bi-fold Door Track**

# BARN DOOR HARDWARE



BDTMHDW78  
BDTMHDW96



BDWM96MB  
BDWM96BRZ  
BDWM96SN

## Top Mount Barn Door Hardware

Type: Top Mount Single Wheel  
Material: Metal Construction  
Designed for Wood Doors: 1-3/8" and 1-3/4" (thickness)  
Maximum Door Weight: 250lbs (smooth operation)  
Kit Includes:

- 1 Hangers Set (pair)
- 2 Track Stoppers
- 5 Rail Mounting Clamps for Rail Size 78-3/4"
- 6 Rail Mounting Clamps for Rail Size 96"
- 1 Flat Track Rail, Length 78-3/4" or 96"
- 1 Floor Bottom Guide
- Mounting Screw Pack

## Bent Strap Barn Door Hardware

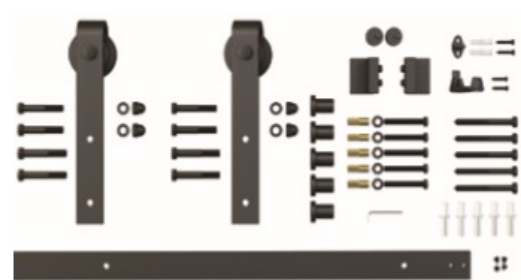

BDBENTSTRAP78(3/4)  
Bent Strap Wheel Set 78-3/4"  
Finish: Matte Black, Bronze, Satin Nickel  
BDBENTSTRAP96(3/4)  
Bent Strap Wheel Set 96"  
Finish: Matte Black, Bronze, Satin Nickel



Barn Door Flush Pull



Barn Door Latch



Bypass Kit

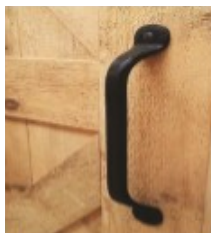

Barn Door Handle



Soft Close Kit



Joiner Kit



# JAMBS, CASING, STOPS AND HINGES

## JAMBS



Clear Pine

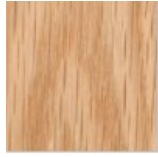

Red Oak



Poplar



Primed

## JAMB PROFILES

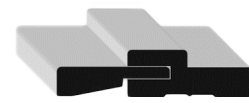

Adjustable Split Jamb  
Adjust up to 1"



Double Rabbeted

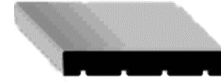

Flat Jamb

## CASING PROFILES



**327**  
PROFILE  
11/16" x 2-1/4"



**356**  
PROFILE  
11/16" x 2-1/4"



**366**  
PROFILE  
11/16" x 2-1/4"



**445**  
PROFILE  
11/16" x 3-1/4"



**Baby RB-3**  
PROFILE  
11/16" x 3-1/2"



**RB-3**  
PROFILE  
11/16" x 3-1/2"



**D488**  
PROFILE  
11/16" x 2-3/4"



**452**  
PROFILE  
11/16" x 2-1/2"



**1x4**  
PROFILE  
11/16" x 3-1/2"

## HINGE FINISH



Flat Black



Light Brass



Antique Brass



Oil Rubbed Bronze



Antique Nickel



Satin Nickel



Bright Chrome



Brushed Chrome

## STOPS

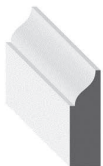

Colonial  
Available Pine  
947



Eased Edge  
Available Primed  
887

# DOOR DETAILS, HANDINGS AND ROUGH OPENING CHART

## FLUSH DOOR CORE

### Hollow Core, HC

- Wood/MDF Frame
- Corrugated honeycomb core
- Optional wood top & bottom rails
- 1-3/8" or 1-3/4" doors
- 2-3" x 16" lock blocks

### Solid Core, SC

- Wood or MDF Frame
- MDF top & bottom rails
- Optional wood top & bottom rails
- 1-3/8" or 1-3/4" doors

## MOLDED DOOR CORE

### Hollow Core, HC

- MDF Frame
- Blocking behind panels for support
- Two particleboard lock blocks
- Optional wood top & bottom rails
- 1-3/8" or 1-3/4" doors

### Solid Core, SC

- Wood Frame
- Optional MDF top & bottom rails
- 1-1/4" wood top & bottom rails available
- 1-3/8" or 1-3/4" doors
- 20 minute fire rating

## HANDINGS

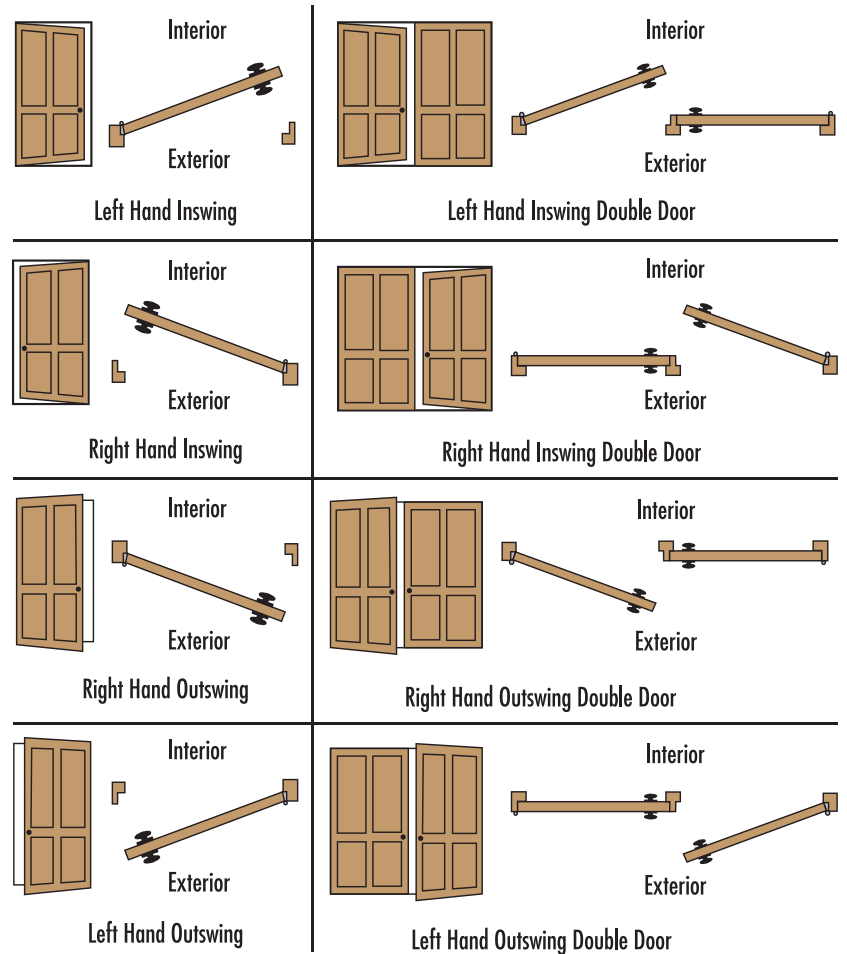

## ROUGH OPENINGS

\*Double door unit dimensions shown are for units with ball and catch only. For double door units with an astragal, add 1/2" to width.

NORMAL DOOR SIZE	SINGLE DOOR WIDTH					DOUBLE DOOR WIDTH*					HEIGHT		
	1/6	2/0	2/4	2/6	2/8	3/0	4/0	4/8	5/0	5/4	6/0	6/8	8/0
Rough Opening Required	20"	26"	30"	32"	34"	38"	50"	58"	62"	66"	74"	82-1/4"	98-1/4"
Unit Dimension	19-1/2"	25-1/2"	29-1/2"	31-1/2"	33-1/2"	25-1/2"	49-1/2"	57-1/2"	61-1/2"	65-1/2"	73-1/2"	81-1/2"	97-1/2"





# Dyke Industries

Dyke Industries is a third generation, family-owned company that has serviced Southeast/Midwest and Mid-Atlantic regions of the U.S. as a whole distributor of building materials, millwork and related products since 1866. We provide a full complement of hardware, door, windows, and trim and maintain an extensive inventory of products from the most popular manufacturers. Our core focus has been servicing customers who concentrate on the residential new construction business and replacement/remodel, both single and multi-family.

Dyke operates fifteen locations in Missouri, Indiana/Ohio, Tennessee, North Carolina, Georgia, Louisiana, and Florida. With a combined 1.75 million square feet of warehouse space, these strategically located outlets allow us to service major metropolitan markets in thirteen states. We are the largest, independent distributor in the Southeastern US.

Our production footprint allows Dyke to out-service our competition with better concentration in individual markets by carrying the right inventory, delivering to our customers multiple times per week with a knowledgeable sales force that is invested in the success of our customers. Our size and scope allows Dyke to leverage its buying power, ensuring that Dyke maintains a competitive advantage while focusing on quality and service.

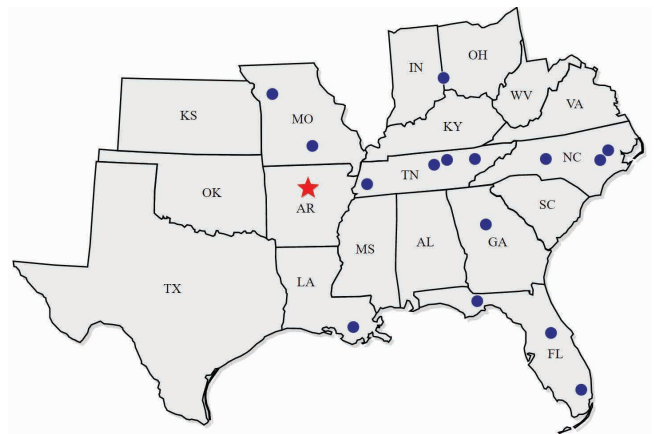

## Why Dyke Industries?

- Over 157 years of stability. Our purchasing autonomy (not being tied to one or two major vendor in any category) allows for strategic sourcing in order to keep our shelves stocked. This is one of our strongest competitive advantages.
- Our branches are strategically located to service key markets that are projected to grow over the next several years.
- We base decisions on long term strategy, not short-term decisions to meet financial obligations.
- Each General Manager is empowered to make decisions on what is best for his or her branch. We are streamlined, eliminating “red tape” and forced on being easy to do business with.
- Dyke is financially secure. We own all our facilities, a fleet of 100+ delivery trucks, and over \$70M in inventory. Our results speak for themselves.
- We are investing in the business from people, to technology, expansion, Warehouse Management Systems, online quoting/ordering tool, website configurations, updated websites with heavy emphasis on branding.



 **Dyke Industries, Inc.**  
*Serving the Building Industry Since 1866*

**Dyke Industries - Cincinnati**  
1360 Harrison Brookville Rd.  
West Harrison, IN 47060  
**859.341.5500**  
[cincinnati.dykedoors.com](http://cincinnati.dykedoors.com)

**Distributed By:**