

# Cub Cadet

## Owner's Manual

### TRACTORS

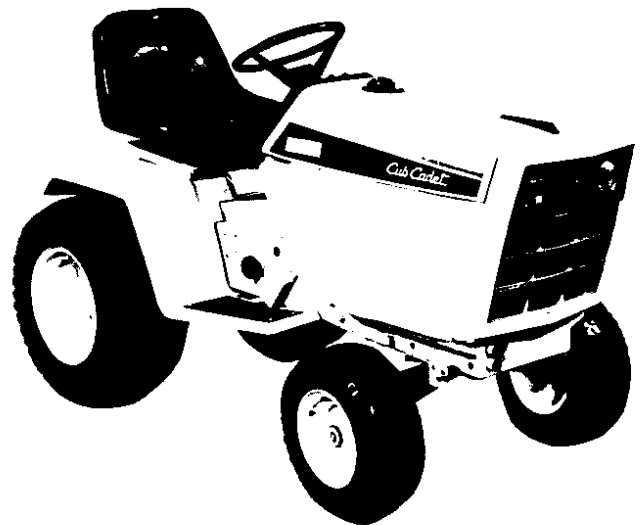

1712 Tractor Shown

### Model Numbers

1210 (680)

1710 (682)

1711 (782)

1712 (784)

### Important:

**Read Safety Rules and  
Instructions Carefully**

Thank you for purchasing  
an American-built product.

**CUB CADET CORPORATION • P.O. BOX 36930 • CLEVELAND, OHIO 44136**

PRINTED IN U.S.A.

FORM NO. 772-3504



# Cub Cadet Corporation Limited One Year Warranty For Outdoor Power Products

## **Cub Cadet Corporation's Promise To You**

We promise you, the first user purchaser, that we will replace or repair any part or parts of your new outdoor power product which is defective in material or workmanship without charge for either parts or labor during the first year following delivery to you.

## **What You Must Do**

We recommend that you take the product back to the dealership where you purchased it at your expense; however, you may also take it to the most convenient authorized Cub Cadet dealer. Transportation charges are your responsibility.

## **Replacement Parts Warranty**

Cub Cadet parts which are furnished and installed under this warranty are themselves within the coverage of this warranty for the duration of the original one year warranty period or for ninety days after installation, whichever period shall expire last.

## **What Is Not Covered**

Tires and tubes are not covered by this warranty, but are warranted by their manufacturer. Regular maintenance replacement items such as spark plugs, ignition points, condensers, filters, and lubricants and maintenance adjustments such as fuel system cleaning, engine tune-up, brake and/or clutch inspection or adjustment, when such replacement or adjustments are made as part of normal maintenance service are excluded from coverage. Any non-Cub Cadet product which you may have installed in or upon the product is also excluded.

No person is authorized to give any other warranties or to assume any other liabilities on the Company's behalf unless made or assumed in writing by the Company, and no person is authorized to give any warranties or to assume any liabilities on the seller's behalf unless made or assumed in writing by the seller.

## **Limitations On Our Responsibility**

Please carefully note that this is a two-way agreement. We promise to make free repairs or replacements as stated, but you agree that except for our obligation to make good on this promise we shall not be responsible for any expenses or inconvenience which you might incur or experience with respect to our product, nor shall we be liable for defects, damage, or failures caused by unauthorized alterations, unreasonable use, accident, or abuse, including failure to provide reasonable and necessary maintenance, after our product has been delivered to you. Some states do not allow the exclusion or limitation of incidental or consequential damages, so the above limitation or exclusion may not apply to you. This warranty gives you specific legal rights, and you may also have other rights which vary from state to state.

## **Personal Use**

The foregoing paragraphs constitute Cub Cadet Corporation's entire warranty with respect to any product purchased and used for personal, family, or household purposes as distinguished from commercial usage.

## **Commercial Use**

In the event our product is used for commercial purposes, INCLUDING FARMING OPERATIONS, the following additional limitations upon the application of this warranty will be applicable to such product.

**THIS WARRANTY IS IN LIEU OF ALL OTHER WARRANTIES, EXPRESSED OR IMPLIED. WARRANTIES OF MERCHANTABILITY AND FITNESS FOR PARTICULAR PURPOSE ARE EXCLUDED, AS ARE ALL OTHER REPRESENTATIONS TO THE USER-PURCHASER, AND ALL OTHER OBLIGATIONS OR LIABILITIES, INCLUDING LIABILITY FOR INCIDENTAL AND CONSEQUENTIAL DAMAGES, ON THE PART OF THE COMPANY OR THE SELLER.**

# CONTENTS

Safe Operations .....	4	Off-Season Storage .....	21
To The Owner .....	6	Optional Equipment and Accessories .....	21
Serial No. Location .....	6	Maintenance Chart .....	22
Controls .....	7	Trouble Shooting .....	23
Operation .....	11	Lubrication Table .....	24
Adjustments .....	13	Lubrication Guide .....	25
Maintenance .....	17	Specifications .....	28



Instructions given with this symbol are for personal safety. Be sure to follow them.



This unit is equipped with an internal combustion engine and should not be used on or near any unimproved forest-covered, brush-covered or grass-covered land unless the engine's exhaust system is equipped with a spark arrester meeting applicable local or state laws (if any). If a spark arrester is used, it should be maintained in effective working order by the operator.

In the State of California the above is required by law (Section 4442 of the California Public Resources Code). Other states may have similar laws. Federal laws apply on federal lands. A spark arrester muffler is available at your nearest engine authorized service center.



To reduce the potential for any injury, comply with the following safety instructions. Failure to comply with the instructions may result in personal injury.

## SAFE OPERATION PRACTICES FOR RIDING VEHICLES

1. Read this owner's manual carefully in its entirety before attempting to assemble or operate this unit. Keep this manual in a safe place for future and regular reference and for ordering replacement parts.
2. This unit is a precision piece of power equipment, not a plaything. Therefore exercise extreme caution at all times.
3. Know the controls and how to stop quickly—**READ THIS OWNER'S MANUAL.**
4. Do not allow children to operate vehicle. Do not allow adults to operate it without proper instruction. Only persons well acquainted with these rules of safe operation should be allowed to use your mower.
5. No one should operate this unit while intoxicated or while taking medication that impairs the senses or reactions.
6. Wear sturdy, rough-soled work shoes and close-fitting slacks and shirts to avoid entanglement in the moving parts. Never operate a unit in bare feet, sandals, or sneakers.
7. To prevent injury, do not carry passengers or give rides. Keep children, pets and bystanders out of the area while mowing. Only the operator should ride on the unit and only ride in the seat.
8. Check overhead clearance carefully before driving under power lines, guy wires, bridges or low hanging tree branches, before entering or leaving buildings, or in any other situation where the operator may be struck or pulled from the unit, which could result in serious injury.
9. To maintain control of the unit and reduce the possibility of upset or collision, operate the tractor smoothly. Avoid erratic operation and excessive speed.
10. Keep the area of operation clear of all persons, particularly small children and pets. Stop engine when they are in the vicinity of your mower. Although the area of operation should be completely cleared of foreign objects, a small object may have been overlooked and could be accidentally thrown by the mower in any direction and cause injury.
11. Clear work area of objects which might be picked up and thrown by the mower in any direction and cause injury.
12. Stop the blade(s) when crossing gravel drives, walks or roads.
13. Disengage all attachment clutches and shift into neutral before attempting to start engine.
14. Disengage power to attachment(s) and stop engine before leaving operating position.
15. Do not put hands or feet near or under rotating parts. Keep clear of the discharge opening at all times as the rotating blade(s) can cause injury.
16. Disengage power to attachment(s) and stop engine before making any repairs or adjustments. Disconnect the spark plug wire and keep the wire away from the plug to prevent accidental starting.
17. Before attempting to unclog the mower or discharge chute, stop the engine. The mower blade(s) may continue to rotate for a few seconds after the engine is shut off. Therefore, be sure the blade(s) have stopped completely. Disconnect the spark plug wire and keep the wire away from the plug to prevent accidental starting.
18. Disengage power to attachment(s) when transporting or not in use.
19. Take all possible precautions when leaving vehicle unattended such as disengaging power-take-off, lowering attachments, shifting into neutral, setting parking brake, stopping engine and removing key.
20. Do not stop or start suddenly when going uphill or downhill. Mow up and down face of steep slopes; never across the face. Use extreme caution if it is necessary to drive the tractor up an incline or back the tractor down an incline because the front of the tractor could lift and rapidly flip over backward which could cause serious injury.
21. Reduce speed on slopes and in sharp turns to prevent tipping or loss of control. Always keep the tractor in gear when going down steep hills to take advantage of engine braking action.
22. Stay alert for holes in terrain and other hidden hazards.
23. Use care when pulling loads or using heavy equipment.
  - A. Use only approved drawbar hitch points.
  - B. Limit loads to those you can safely control.
  - C. Do not turn sharply. Use care when backing.
  - D. Use counterweight(s) or wheel weights when suggested in owner's manual.
24. Watch out for traffic when crossing or near roadways.
25. When using any attachments, never direct discharge of material toward bystanders nor allow anyone near vehicle while in operation.
26. Handle gasoline with care. It is highly flammable.
  - A. Use approved gasoline container.
  - B. Never remove cap or add gasoline to a running or hot engine or fill fuel tank indoors. Wipe up spilled gasoline.
  - C. Open doors if engine is run in garage. Exhaust fumes are dangerous. Do not run engine indoors.

27. Keep the vehicle and attachments in good operating condition, and keep safety devices in place. Use guards as instructed in operator's manual.
28. Keep all nuts, bolts, and screws tight to be sure the equipment is in safe working condition.
29. Never store the equipment with gasoline in the tank inside a building where fumes may reach an open flame or spark. Allow engine to cool before storing in any enclosure.
30. To reduce fire hazard, keep engine free of grass, leaves or excessive grease.
31. The vehicle and attachments should be stopped and inspected for damage after striking a foreign object. The damage should be repaired before restarting and operating the equipment.
32. Do not change the engine governor settings or overspeed the engine.
33. When using the vehicle with mower, proceed as follows:
  - (1) Mow only in daylight or in good artificial light.
  - (2) Never make a cutting height adjustment while engine is running if operator must dismount to do so.
  - (3) Shut the engine off and wait until the blade comes to a complete stop before removing the grass catcher.
  - (4) Check blade mounting bolts for proper tightness at frequent intervals.
34. Check grass catcher bags frequently for wear or deterioration. For safety protection, replace only with new bag meeting original equipment specifications.
35. Look behind to make sure the area is clear before placing the transmission in reverse and continue looking behind while backing up. Disengage blades before shifting into reverse and backing up.
36. This unit should not be driven up a ramp onto a trailer or truck under power, because the unit could tip over, causing serious personal injury. The unit must be pushed manually to load properly.

# To The Owner

Assembled in this manual are operation, lubrication, and maintenance instructions for the Cub Cadet 1210, 1710, 1711 and 1712 Tractors. The material has been prepared in detail to help you better understand the correct care and efficient operation of your tractor. Before you operate the tractor, study this manual carefully. Additional copies may be ordered from your dealer at a nominal price.

Your local authorized dealer is interested in the performance you receive from your tractor. He has factory-trained servicemen, informed in the latest method of servicing tractors, modern tools, and original-equipment service parts which assure proper fit and good performance.

The Cub Cadet 1210, 1710, 1711 and 1712 Tractors have a hydrostatic drive. It is the best hydrostatic drive unit available and will require minimum ser-

vice if recommended operation and maintenance procedures are followed.

To obtain top performance and assure economical operation the tractor should be inspected, depending on its use, periodically, or at least once a year, by your authorized dealer.

When in need of parts, always specify the model, chassis, and engine serial numbers, including the prefix and suffix letters. Write these serial numbers in the space provided on this page.

Should you have difficulties with the unit consult your authorized dealer. **UNDER NO CIRCUMSTANCES SHOULD YOU ATTEMPT TO SERVICE THESE UNITS YOURSELF.** Only your dealer is authorized to repair or replace units on this drive under the terms of the warranty. Should you desire additional information not found in this manual, contact your authorized Cub Cadet dealer.

## SERIAL NUMBER LOCATION



FIGURE 1.

Serial number plate is located near left rear fender. See figure 1.

**NOTE:** LEFT and RIGHT indicate the left and right sides of the tractor when facing forward in the driver's seat. Reference to FRONT indicates the grille end of the tractor; to REAR the drawbar end.

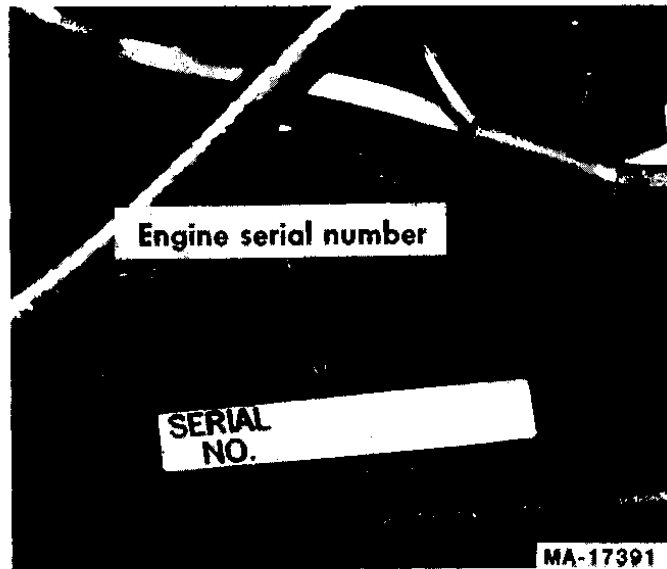

FIGURE 2.

MODEL \_\_\_\_\_

DELIVERY  
DATE \_\_\_\_\_

# CONTROLS

Your Cub Cadet Tractor has been safety engineered. Thoroughly acquaint yourself with all the instruments and controls before attempting to start or operate the tractor.

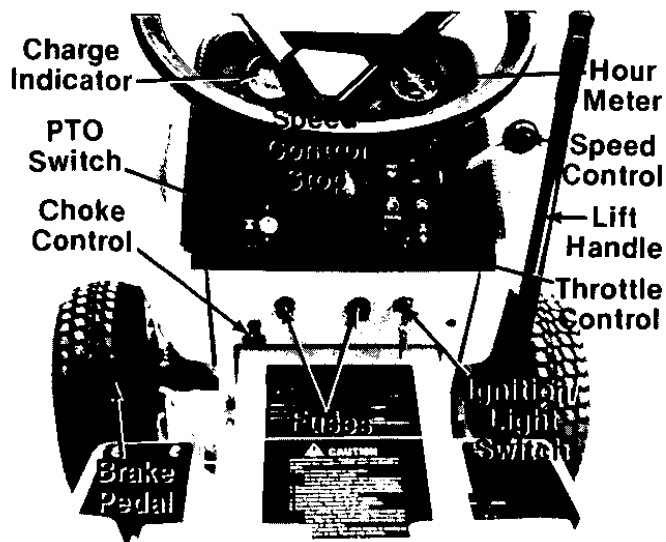

FIGURE 3. 1710 Shown

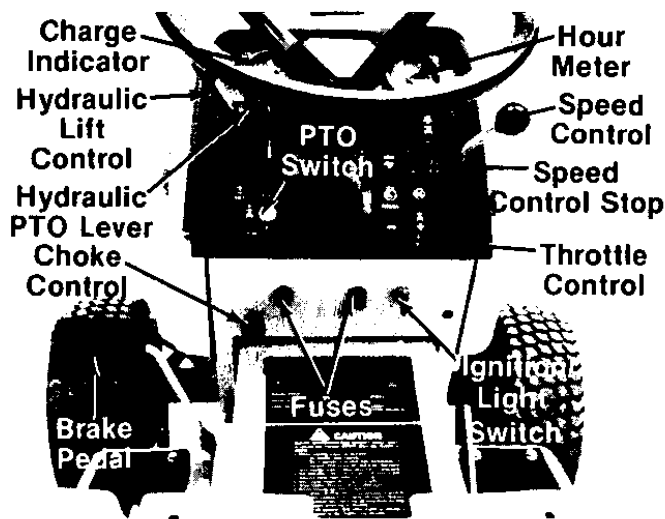

FIGURE 4. 1712 Shown

## THROTTLE CONTROL LEVER

This lever controls the speed of the engine. When set in a given position, it will maintain a uniform engine speed. See figure 3 or 4.

When using power take-off operated equipment, best performance is achieved with the throttle lever in the "FAST" position.



This symbol shows slow position.

This symbol shows fast position.

## CHOKE CONTROL

The choke control is operated manually. Pull knob out to choke engine. Push knob in to open choke. See figure 3 or 4.

## SPEED CONTROL

The lever is used to select any speed from a standstill "N" position to eight miles per hour in the forward direction and to four miles per hour in the reverse direction.

Moving the speed control lever forward provides increased forward speed, and moving the lever rearward provides the reverse speeds. Refer to figure 3 or 4.

**NOTE:** Do not rest your foot on the brake pedal while driving the tractor as this would cause the speed control lever to return to the "N" position.

## SPEED CONTROL STOP

An adjustable speed control stop is provided to allow the operator to return to a predetermined speed.

## BRAKE PEDAL

Brake pedal must be pressed all the way down to activate the safety starting switch. When brake pedal is in the depressed position it automatically moves the speed control lever to the "N" position.

The tractor can be stopped either by pressing the pedal all the way down, or placing the speed control lever in the "N" position.

## LOCKING THE BRAKE

Always lock the brake when the tractor is parked on a grade. To lock the brake, press down on the pedal; then place the brake pedal lock in the engaged position. See figure 5. To disengage the lock, press down on the pedal, lift the lock up and place it in the disengaged position.

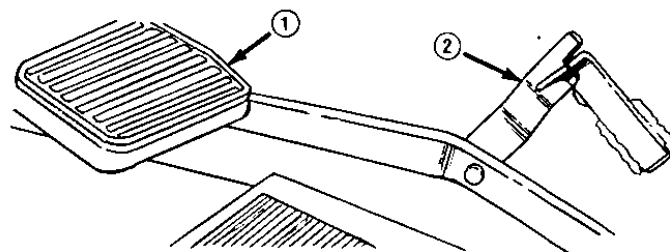

FIGURE 5.

1. Brake pedal
2. Brake pedal lock



The hydrostatic transmission will not hold the tractor on a hill. In a short period of time (depending on the hill) the oil will drain from the transmission and allow the tractor to roll down hill. To avoid an accident and/or possible injury, lock the brake.

### IGNITION/LIGHT SWITCH

The combination lights and ignition switch is a four position switch. See figure 6.

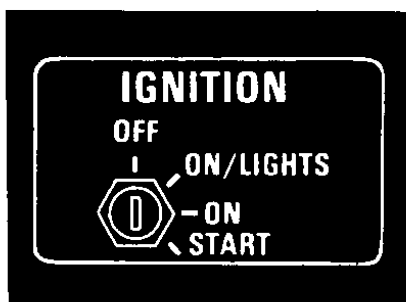

FIGURE 6.



Remove the key from the tractor when the tractor is not in use to prevent accidental starting and battery discharge.

### FRONT POWER TAKE-OFF (PTO)

The front power take-off is an electric clutch operated by a toggle switch on the left side of the instrument panel. See figure 3 or 4.

### INTERLOCKS (Not Shown)

Interlock safety switches are located at and activated by the clutch-brake pedal, the PTO switch and the seat.

The safety starting switches activated by the brake pedal and the power take-off clutch switch serve to prevent starting the engine accidentally. The clutch-brake pedal must be depressed and the PTO switch in the "OFF" position before engine will start.

When using PTO operated equipment, the operator must remain in tractor seat at all times. If operator should leave tractor seat without turning off the PTO switch, the engine will automatically shut off. In addition, the PTO switch must be in the "OFF" position when shifting tractor into reverse or the PTO will shut off automatically. To

re-engage the PTO, shift unit into neutral. Move PTO switch to the "OFF" position. Then pull knob out and lift up to start position and release.

### CHARGE INDICATOR

This instrument indicates whether the alternator is charging or the battery is discharging. If it shows discharge continuously, investigate the cause to avoid completely discharging the battery and possible damage to the charging circuit.

### HOURLY METER

The hour meter is located on the instrument panel. See figures 3, 4 and 7. It indicates the actual hours of engine operation, enabling the operator to determine without guesswork, when lubrication, change of oil or periodic inspections are necessary. It also provides a means of computing cost of specific jobs. The hour meter operates whenever the engine is running or the ignition key is in the "ON" position.

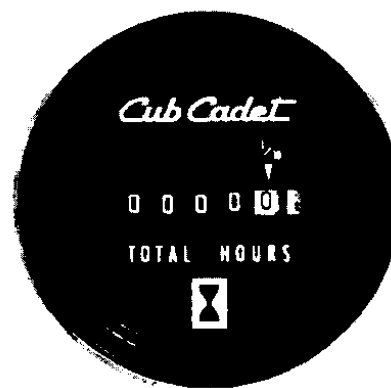

FIGURE 7.

### FUSES (Electric Lighting and Electric Power Take-Off Clutch)

There are two fuses on the tractor pedestal. The fuse on the left is for the lights, the fuse on the right is for the electric clutch. See figure 3 or 4.

### LIFT HANDLE

#### 1210 and 1710 Tractors Only

The lift handle is used to lift or lower equipment used with the tractor. The equipment can be set in multiple positions by depressing the button on the handle and releasing it when the desired position is reached.

An additional feature has been provided to give increased float capability to the deck by depressing the button and rotating the pin into the slot as shown in figure 8.



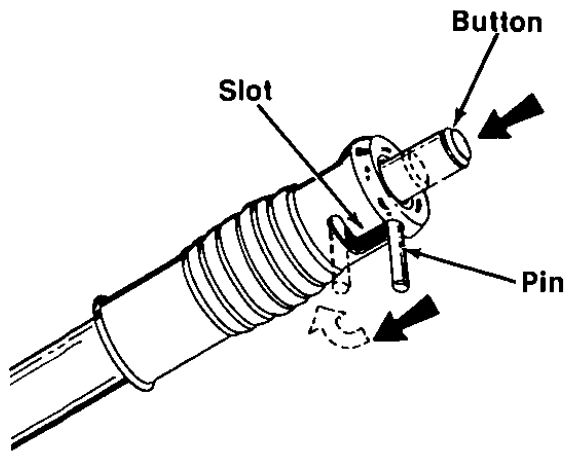

FIGURE 8.

The cam stop may be adjusted to allow the implement to return to a single preset height. See figure 9.

With implement in desired height position, release cam stop by turning locking knob counter-clockwise. Turn cam stop until it contacts lift bracket. Lock cam stop into this position by turning cam knob clockwise.

**NOTE:** Refer to the equipment manual for proper hitching instructions.

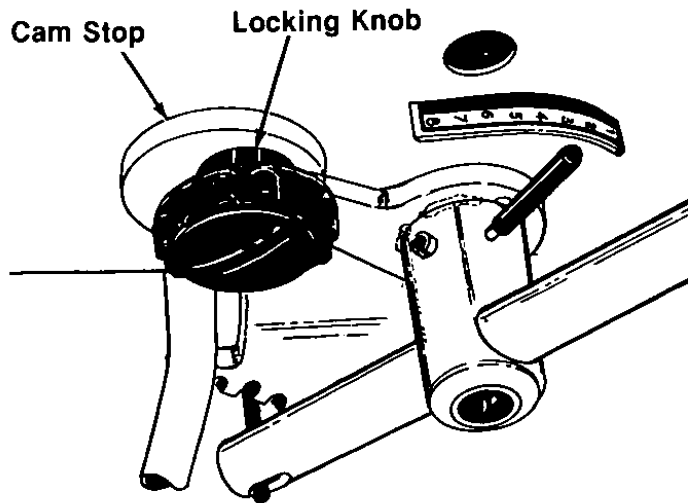

FIGURE 9.

**HYDRAULIC LIFT**  
1711 and 1712 Tractors Only

The hydraulic lift is ready to operate when the engine is running.

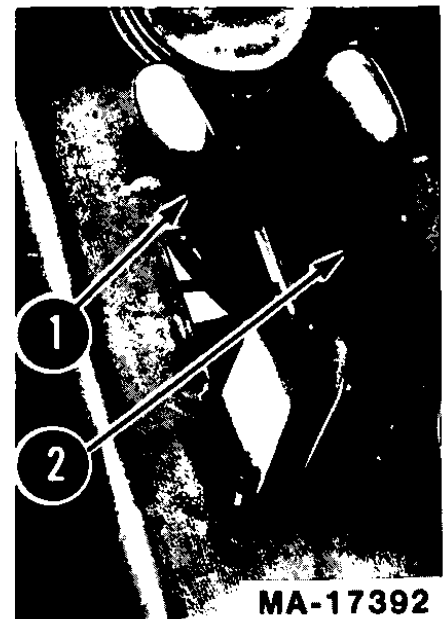

Figure 10.

1. Hydraulic lift control lever
2. Front hydraulic outlet control lever (Standard on 1712 Tractor)

The hydraulic lift control lever is spring loaded. To raise the equipment move the lever back, toward the tractor seat. To lower the equipment move the lever forward.

The front hydraulic outlet control lever (standard on 1712 tractor) provides for "on-the-go" angling of a front mounted blade.

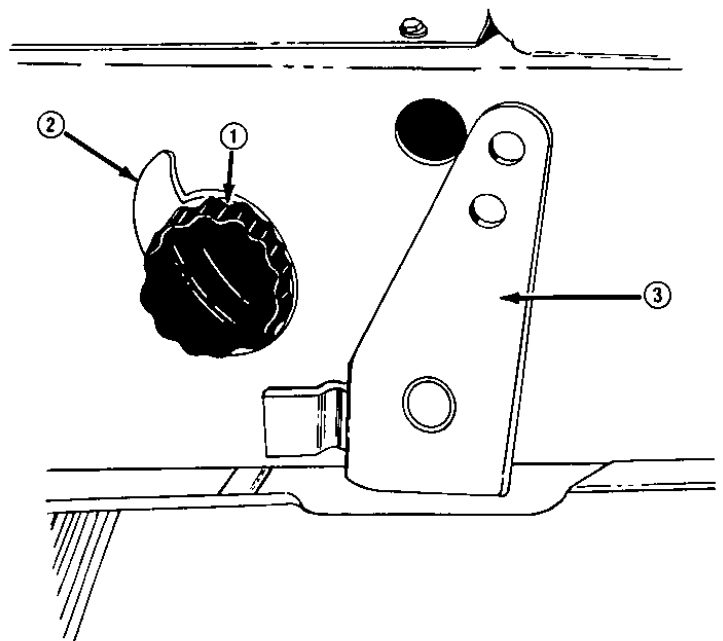
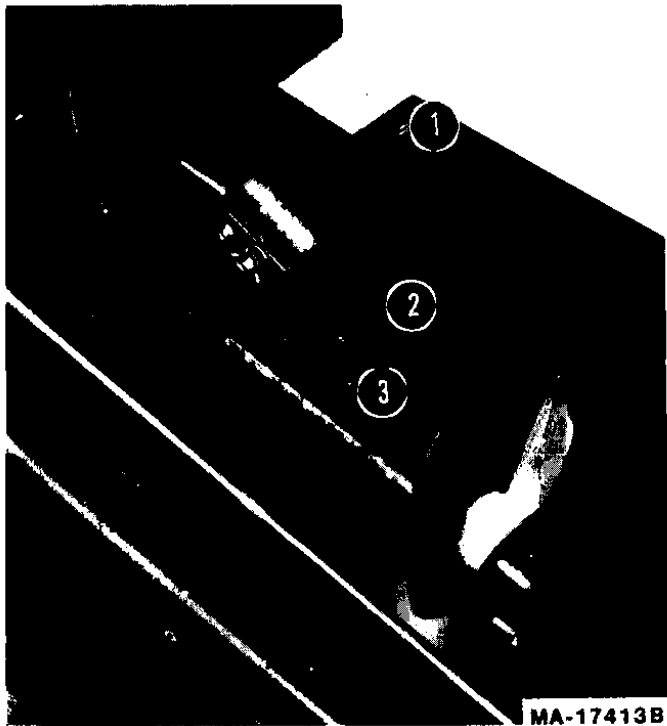

FIGURE 11.

1. Locking knob
2. Cam stop should be turned around
3. Rockshaft arm

The cam stop may be adjusted to allow the implement to return to a single preset height. See figure 11.

With implement in desired height position, release cam stop by turning locking knob counterclockwise. Turn cam stop until it contacts lift bracket. Lock cam stop into this position by turning cam knob clockwise.



**FIGURE 12.**

1. Lift bracket
2. Hole (not seen) for bolt
3. Lift arm

Equipment is normally operated in a "Float" position (implement free to move upward).

To operate equipment in a fixed "Locked" position, where down pressure of the implement is required (blade work), remove frame cover and install bolt, 1/2 x 1-1/8-inch, (not furnished with tractor) between the lift arm and lift bracket. See figure 12.

## **GASOLINE TANK**

The gasoline tank is located under the hood.

## **FUEL SHUT-OFF VALVE**

The fuel shut-off valve is located below the gasoline tank.

To turn the fuel on, turn the knob counterclockwise to the stop.

To turn the fuel off, turn the knob clockwise until it is tight.

## **HOOD AND NOISE ISOLATION PANELS**

The tractor hood is arranged to swing up and forward for easy access to the engine compartment. The hood locks automatically when raised. To lower hood, release latch on left side by gently pushing hood up to release tension and pull latch to left. See figure 13. Also, whenever engine maintenance is required, the noise isolation panels can be readily removed by removing the two wing nuts and two washers (one on each side) and disconnecting the panel spring.

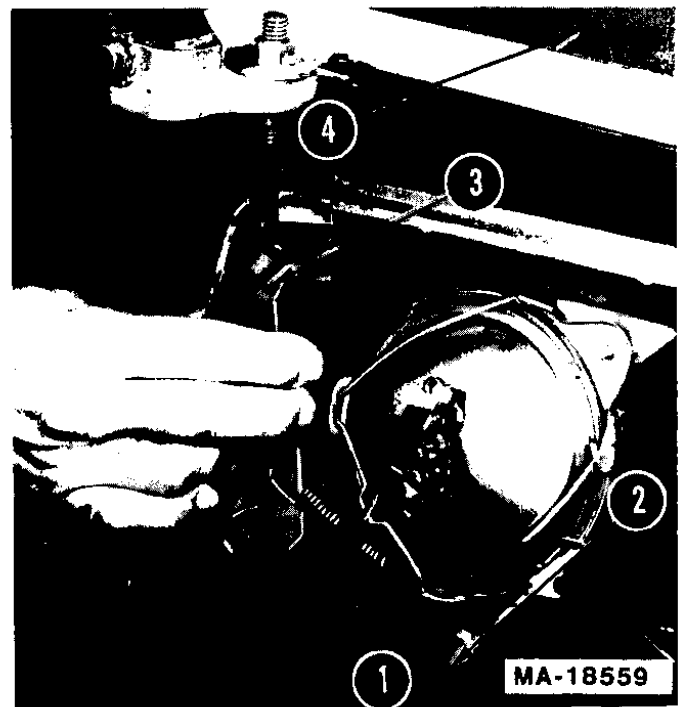

**FIGURE 13.**

1. Noise isolation panel (one on each side)
2. Panel spring
3. Latch
4. Hood

# OPERATION



## CAUTION

**RECEIVE INSTRUCTION**—Read operator's manual. Learn to operate this machine **SAFELY**. Don't risk **INJURY** or **DEATH**.

1. Before starting engine or operation:  
Be familiar with controls.  
Be in operator's position with transmission in neutral, PTO turned off, and brake depressed.
2. Keep shields in place. Keep away from moving parts.
3. **NO RIDERS!** Keep all people and pets a safe distance away. Look before backing up.
4. Don't point mower discharge at people.
5. Avoid slopes. Tractors can be rolled over.
6. Before leaving operator's position:  
Shut off PTO. Place transmission in neutral. Set parking brake. Shut off engine. Remove ignition key. Wait for all movement to stop before servicing or cleaning.
7. Do not fill gasoline tank when engine is running or while engine is hot. Tighten cap securely.

## BEFORE OPERATING YOUR TRACTOR

1. Before you operate the tractor study this manual carefully. It has been prepared to help you operate and maintain your tractor with utmost efficiency.
2. Familiarize yourself with the operation of all the instruments and controls.
3. Fill the fuel tank with clean, fresh, lead-free, low-lead or regular grade leaded gasoline.
4. Check the engine and transmission oil level.
5. Clean the air cleaner element if necessary.
6. Check the tire inflation pressures.
7. Adjust the seat for operator's maximum comfort, visibility, and complete control of the tractor.
8. Remove noise isolation panels and clean any accumulated grass and debris from the intake fan on engine.
9. Make certain that the backside of the grille is clean and unobstructed. Pull forward on top edge to expose rear side of grille. Remove by hand any accumulated grass and debris.

10. Refer to various sections of the operator's manual for additional information.

## STARTING THE ENGINE

**NOTE:** This unit is equipped with a safety interlock system for your protection. The purpose of the safety interlock system is to prevent the engine from cranking or starting unless the brake pedal is depressed and the PTO switch is in the off position. In addition, the PTO lever must be in the off position when the unit is put into reverse or the PTO will shut off. Operator must remain in the seat when the PTO is on or the engine will shut off.



## WARNING

Do not operate the tractor if the interlock system is malfunctioning because it is a safety device, designed for protection.

1. Pull choke control button to full choke position. Less choking may be necessary due to variations in temperature, grade of fuel, etc. Little or no choking will be needed when the engine is warm.
2. Place the throttle on the idle position.
3. To start the engine, safety starting switches must be activated by pressing the brake pedal all the way down and moving the power take-off clutch switch to the OFF position.

**NOTE:** The speed control lever will return to neutral when the brake pedal is pressed all the way down.

4. Turn the ignition key clockwise to the "START" position and release it as soon as the engine starts; however do not operate the starter for more than 30 seconds at any one time. If the engine does not start within this time, turn the key "OFF" and wait a few minutes, then try again.
5. After the engine starts, slowly release the brake pedal and gradually push the choke control button all the way in. Do not use the choke to enrich the fuel mixture, except as necessary to start the engine.

## STOPPING THE ENGINE

Move the throttle lever to the "SLOW" position and allow the engine to idle for a short time before stopping. Then turn the key to the "OFF" position.

**NOTE:** Remove the key to prevent accidental starting and battery discharge if equipment is left unattended.

## COLD WEATHER STARTING

Engine starting is possible in cold weather providing the correct weight of engine oil is used, the battery is fully charged, and the proper starting procedure is followed. The best procedure for starting at temperatures near or below freezing is as follows:

1. Pull the choke all the way out into the full choke position.
2. Move the throttle lever to idle position.
3. Press the brake pedal all the way down and be sure the power take-off switch is in the off position. The safety interlocks will prevent starting unless this is done.
4. Move the key switch into the start position and hold until the engine starts; however, do not operate the starter for more than 30 seconds at any one time. As soon as the engine starts, slowly push the choke in part way.



### CAUTION

During operation do not run the engine in confined area such as storage building any longer than is necessary. Immediately move the tractor outside into the air.

**NOTE:** In cold weather the starting motor may disengage prematurely. This is caused by the engine firing once but failing to continue running. If this happens several times, the engine will be flooded and it will be necessary to start as described in step 5.

5. Leave the throttle in the slow position but push the choke in all the way; then turn the ignition key to the start position and slowly pull the choke out to the position which will cause the engine to start and continue running. If the engine falters after putting tractor into motion, pull the choke out part way until the engine runs smoothly, then gradually push the choke back in as the engine warms.

## DRIVING THE TRACTOR

1. Depress the standard brake pedal, release the brake lock, and let the pedal up. Move the throttle lever to the position where the engine operates best for the load to be handled.
2. Start the tractor in motion by moving the speed control lever slowly forward or rearward to desired speed.



### CAUTION

Avoid sudden starts, excessive speed, sudden stops. Keep vehicle in gear when going down hills.

**NOTE:** When using power take-off operated equipment, best performance is achieved with the throttle lever in the "FAST" position.

Always be sure the rear wheels are free to turn. Under any adverse conditions, do not attempt to free the tractor by speeding up the engine and suddenly engaging the clutch. Try backing out instead of going forward.



### CAUTION

Do not leave the seat of the tractor without depressing the brake pedal and setting the brake lock. If leaving the tractor unattended, also turn the ignition key off and remove the key.

## DRIVING ON SLOPES

Before operating the tractor on any slope, walk the slope to look for possible hazards such as rocks, mounds, ruts, stumps or other surface irregularities which could cause an upset.

Back the tractor with implement up the steepest portion of each slope you intend to work. If the tractor cannot negotiate the slope in reverse, the slope is too steep to be worked.



### CAUTION

Always drive up or down the face of a slope. Do not drive so that the tractor may tip over sideways.

Avoid turns when driving on a slope. If a turn must be made, turn down the slope. Turning up a slope greatly increases the chance of a roll over.

Avoid stopping when driving up a slope. If it is necessary to stop while driving up a slope, start up smoothly and carefully to reduce the possibility of flipping the tractor over backward.

## STOPPING THE TRACTOR

Move the speed control lever to the "N" position or use the standard brake pedal. Before dismounting always lock the brake pedal and turn the ignition "OFF." Also disengage the power take-off control switch.



## CAUTION

Always engage brake pedal lock, lower equipment and shut off engine before dismounting. Never start engine from ground.

### OPERATING THE FRONT POWER TAKE-OFF CLUTCH (PTO)

**NOTE:** Be certain to follow break-in instructions, listed below.

1. Move the throttle lever back to the medium or "SLOW" position.
2. Flip the toggle switch to the "ON" position.
3. Advance throttle to operating speed (full speed).
4. The operator must remain in tractor seat at all times. If operator should leave tractor seat without turning off the power take-off switch, the engine will automatically shut off.
5. PTO switch must be in the "OFF" position when shifting the tractor into reverse or the PTO will shut off automatically. To re-engage the PTO, shift unit into neutral. Move PTO switch to "OFF" position. Then pull knob out and lift up to start position and release.

### FRONT PTO CLUTCH BREAK-IN PROCEDURE

To break-in the components and increase the life of the clutch assembly, proceed as follows.

1. Attach mowing deck, snow thrower, etc. to the tractor.
2. Adjust the belt tension as recommended in attachment owner's manual.
3. Engage and disengage the PTO ten to fifteen times without any load (not cutting grass, not blowing snow, etc.).

## ADJUSTMENTS

### ADJUSTING THE SEAT

Before starting the tractor, adjust the seat to the most comfortable driving position. Tilt the seat forward over the steering wheel, loosen the four cap screws in the seat support, and slide the seat assembly forward or rearward to the position which is most comfortable for the operator. See figure 14.

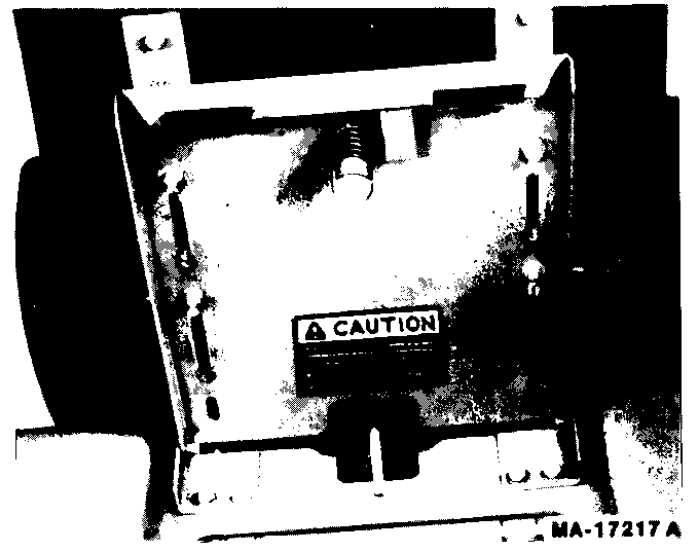

**FIGURE 14.**

Retighten the cap screws after the seat is adjusted.

**NOTE:** The battery is located in a well under the operator's seat for ease in servicing or replacement when necessary.

### ADJUSTING THE POWER TAKE-OFF CLUTCH

The clutch is factory adjusted and should not require further adjustment under normal operating conditions. However, if the clutch fails to operate properly check as follows:

Check fuse on pedestal.



## CAUTION

To avoid possible injury, always disengage all clutches, move speed control into neutral, depress the brake, set the brake pedal lock and turn the ignition "OFF" before working on the machine.

Using a feeler gauge, check the air gap. See figure 15. Insert feeler gauge into one of three access slots located around the outside of the brake plate. The air gap should be .010-.015-inches. Adjust the self-locking nuts to obtain the proper clearance. Repeat the operation in all three access slots.

**NOTE:** If brake plate drags on clutch at .010-.015-inches air gap, increase air gap to .020-inches.

If the above procedure does not work, see your authorized dealer.

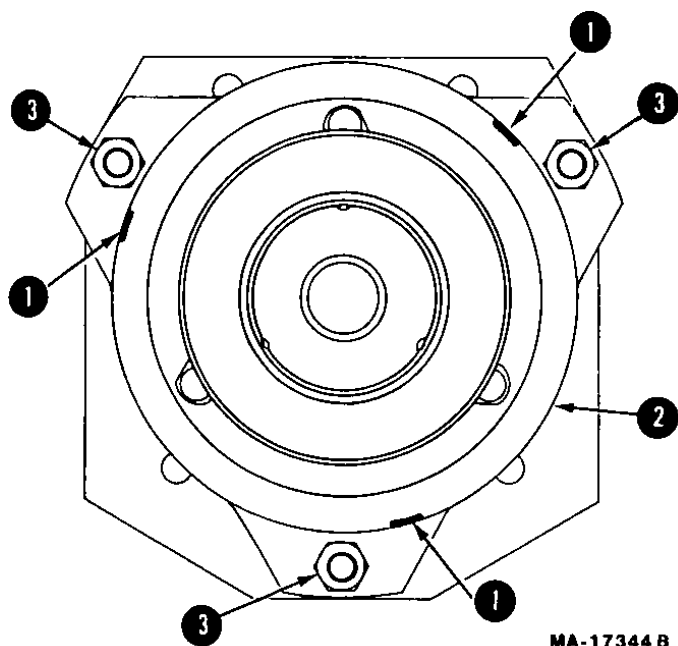

FIGURE 15.

1. Access slots
2. Brake plate
3. Self-locking nuts

#### ADJUSTING THE BRAKES

During normal operation of this machine, the brakes are subject to wear and will require periodic examination and adjustment.

With the brake pedal disengaged, remove the clevis pinned end of one of the brake rod assemblies from the jackshaft assembly by removing the cotter pin from the clevis pin. See figure 16.

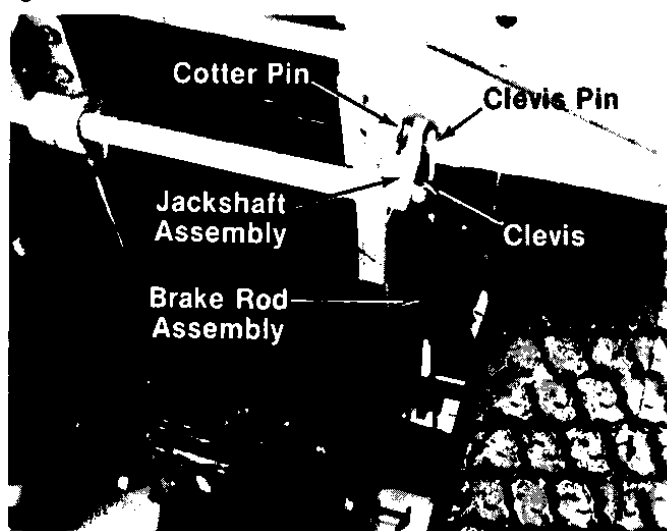

FIGURE 16.

Thread the clevis onto the brake rod one turn. Reconnect the clevis to the jackshaft assembly. There should be a minimum amount of clearance (no drag) between the brake pads and the rotor. See figure 17. If not, repeat adjustment as necessary.

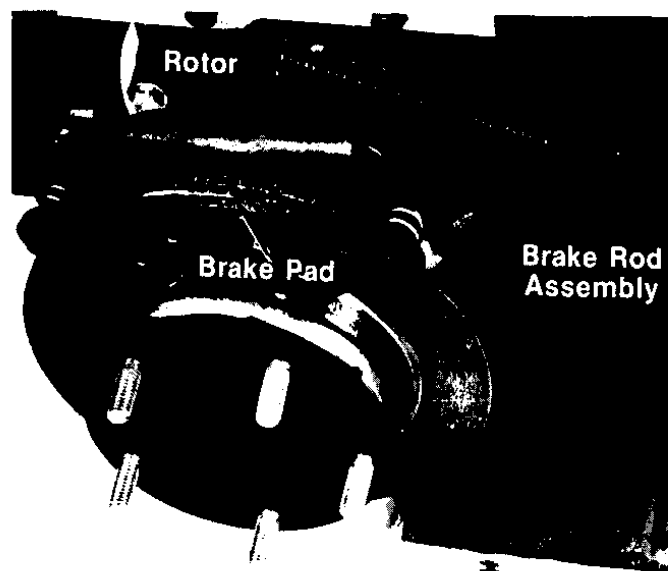

FIGURE 17.

**NOTE:** Figure 17 is shown with the wheel and fender assembly removed for clarity.

Repeat the adjustment on the brake rod assembly on the other side of the tractor.

Recheck brake adjustment and insure proper brake operation before operating the tractor.

#### WHEEL ALIGNMENT

The front wheels should toe-in approximately 1/8".

Measure the distances A and B on the front wheels. See figure 18.

**NOTE:** Dimension B should be approximately 1/8 inch less than dimension A.

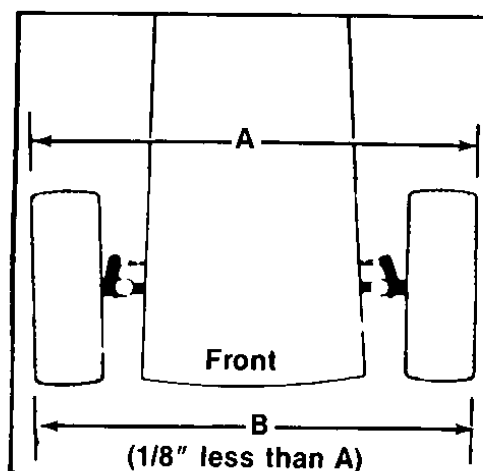
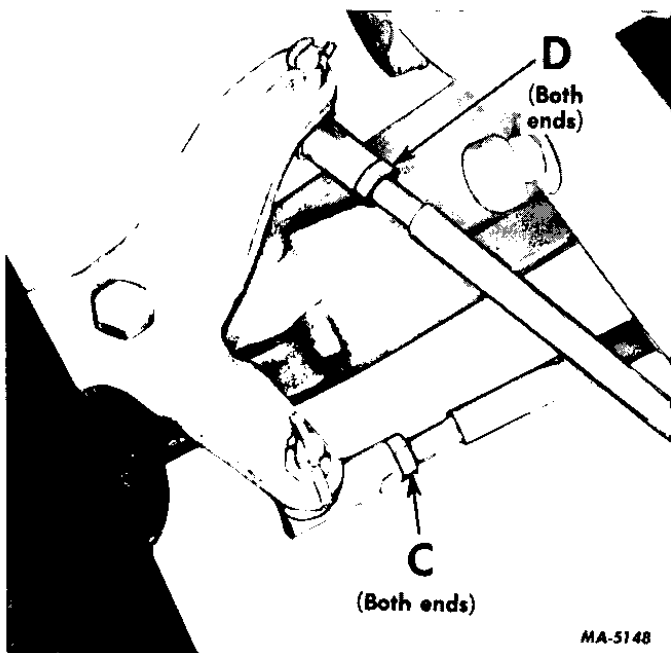

FIGURE 18.

#### Front wheel adjustments.

To adjust the toe-in remove one ball joint, loosen the lock nut "C" at the ball joint and turn the tie rod ball joint in or out as required.



**FIGURE 19.**  
Tie rod and drag link ball joints.

### TURNING RADIUS

The front wheels should have an equal angle for left and right turns. If adjustment is necessary, remove ball joint and loosen lock nut "D", turn the drag link ball joint clockwise or counterclockwise as required. See figure 19.



### CAUTION

Be sure all parts are reassembled tight with cotter pins in place and spread.

### CARBURETOR ADJUSTMENTS



### WARNING

If any adjustments are made to the engine while the engine is running (e.g. carburetor), disengage all clutches and blades. Keep clear of all moving parts and be careful of heated surfaces and muffler.



### CAUTION

To avoid injury or an accident, be sure the brake pedal is in the locked position, transmission is in neutral, and any equipment is disengaged before starting engine to make carburetor adjustments.

The carburetor is adjusted at the factory and under normal operating conditions it will not require readjusting. However, if the engine does not operate properly, what may appear to be a faulty carburetor adjustment is in many cases a clogged air filter. This possibility should be ruled out before attempting to readjust carburetor. Refer to "MAINTENANCE."

**NOTE:** To prevent possible damage to the carburetor needles, be very careful closing the carburetor needles before basic adjustments are made. Improper adjustment of the carburetor may result in engine damage.

### (1210 TRACTOR ONLY)

**NOTE:** Air cleaner has been removed from illustrations in order to show carburetor.

### Adjusting the High-Speed Adjustment Screw

Turn the high speed adjustment screw counterclockwise approximately two turns from the closed position and start the engine. Refer to figure 20.

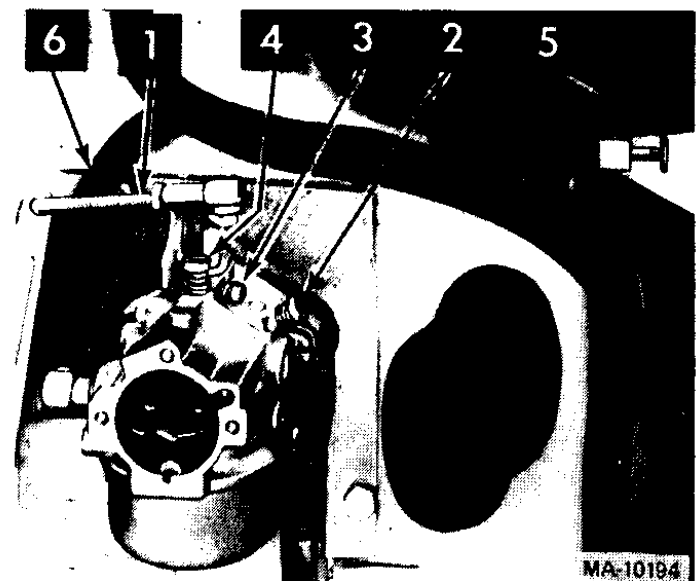

**FIGURE 20.**

1. Governor control rod
2. Idle adjusting screw
3. Idle speed screw
4. High speed adjustment screw
5. Fuel shut-off valve
6. Fuel line

Be sure the choke is fully open (knob fully in) when adjusting.

After the engine has reached normal operating temperature, place the throttle lever in the fast position and turn the high speed adjustment screw clockwise to the leanest mixture that will allow satisfactory acceleration and steady governor operation. Then, turn counterclockwise to the richest mixture that allows satisfactory operation. The difference between the rich and lean points is about ½ turn. Set the mixture to the rich end of this range.

If the engine misses and backfires under load, the high speed mixture is too lean. The high speed adjustment screw must be turned counterclockwise 1/8 turn at a time until the condition is corrected.

If the engine shows a sooty exhaust and is sluggish under load, the high speed mixture is too rich. The high speed adjustment screw must be turned clockwise 1/8 turn at a time until the condition is corrected.

### Adjusting the Idle Adjustment Screw

After the high speed adjustment screw is adjusted, it may be necessary to readjust the idle adjustment screw as each affects the other. Refer to figure 20.

Close the idle adjustment screw to its seat by turning it clockwise; then open it one turn. Start the engine and operate it at fast idling speed (without any load) until thoroughly warm.

While the engine is running at fast idle speed, it is advisable to screw in the idle speed screw a few turns to keep the engine from stopping when the throttle lever is moved to the fully retarded "SLOW" position. The engine will then be idling at a fairly high speed and the idle speed screw can be backed out a little at a time until the desired idle speed is obtained (1800 RPM).

If the engine misses or rolls while backing out the idle speed screw, the idle adjustment screw may be adjusted in or out until the engine operates smoothly. Speed up the engine for a few seconds; then recheck the idle adjustment. A slight adjustment in or out will give the smoothest idle.



Carbon monoxide fumes can be fatal! Do not make any adjustments to the carburetor in a confined area such as a storage building. Move the tractor outside into the air.

(1710, 1711 and 1712 TRACTORS)

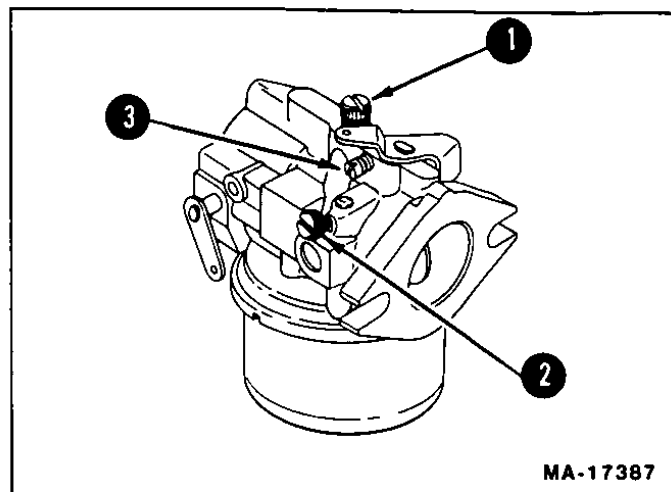

FIGURE 21.

1. Main fuel screw
2. Idle fuel screw
3. Idle speed screw

If readjustment becomes necessary, stop the engine, then turn the MAIN and IDLE fuel adjusting screws all the way in, until they bottom lightly. Refer to figure 21.

### Main Fuel Adjustment

Preliminary setting—turn screw out 2½ turns. Final setting—start engine and raise engine speed to maximum governed, no load speed. Turn screw in just until engine speed decreases and note the position of the screw. Now turn the screw out. The engine speed will first increase, but then decrease as screw is turned out. Note the position of screw when engine speed starts to decrease. Set the screw midway between the two points noted above.

### Idle Speed Adjustment

Run engine at maximum governed, no load speed for a minimum of 30 seconds, then allow engine speed to fall to idle or put throttle into idle position. Set engine speed to 1200 (± 75 RPM) by turning the idle speed screw in or out.

### Idle Fuel Adjustment

Set the idle fuel mixture by turning the idle fuel screw out, from the closed position, ¾ to 1 full turn.



# MAINTENANCE

## ENGINE OIL

The engine crankcase is filled with ship-away oil. This oil may be used for the first 5 hours of engine operation at temperatures between + 90 degrees F. and 0 degrees F. If temperatures are not within this range, drain the oil from the crankcase and replace with new oil as specified in the “**LUBRICATION TABLE**”. The engine oil must be drained and replaced with new oil every 25 hours of engine operation.

To aid starting, the selection of crankcase lubricating oils should be based on the lowest anticipated temperatures until the next drain period. Refer to “**LUBRICATION TABLE**”.

IH Low Ash Engine Oil or other oil meeting API Service Classification SF is recommended. For maximum engine life select API SF oils with lowest levels of barium, calcium, or magnesium additives and minimum ash content (approximately 0.5%). Lubricant suppliers will normally furnish this information on their engine oils.

Multi-viscosity numbered oils such as SAE 10W-30 or SAE 10W-40 can be used above 32 degrees Fahrenheit.

Regularly check the oil level of the engine crankcase to see that it is filled to the correct level.

**NOTE:** Check the oil level only while the engine is stopped and have the tractor level.

Always keep the oil level between the “FULL” and the “LOW” marks on the dipstick. When checking the oil level the dipstick must be withdrawn and wiped clean, then inserted all the way and withdrawn for a true reading.

### Filling the Crankcase

To fill the crankcase with oil, place the tractor on a level surface. Clean the area around oil fill before removing combination oil filler cap and dipstick.

**NOTE:** Never overfill the engine crankcase. Engine may overheat and/or damage may result if the crankcase is below the “LOW” mark or over the “FULL” mark. For oil capacity refer to the “**SPECIFICATIONS**” and “**LUBRICATION TABLE**” section.

Remove the cap and dipstick and fill to the full mark on the dipstick. POUR SLOWLY. Capacity 4 pints (1210 only) or 3 pints (1710, 1711 and 1712). When checking the oil level, push the dipstick assembly firmly but slowly until cap bottoms on tube. DO NOT OVERFILL. Dipstick assembly must be pushed fully into tube at all times when engine is operating.

## HYDROSTATIC DRIVE HYDRAULIC FLUID FILTER

Remove the throw-away can-type filter and replace with a new filter after the first 10 hours and 50 hours of operation, and every 100 hours of operation thereafter.

**NOTE:** Clean the outside area before removing the filter to keep dirt from getting into the transmission case. If a mower is mounted on the tractor, the mower must be lowered to facilitate removal of the filter.

To remove the filter, turn the filter counterclockwise using an automotive type filter wrench.

Before installing the new filter, apply a coating of oil on the filter gasket. Thread the filter on by hand until tight enough to seat the gasket. Loosen the filter. Then turn it until the gasket contacts the base. Tighten the filter an additional one half turn. Start engine and allow it to run for a few minutes. Shut engine off and check for leaks, check oil level in transmission case.

## AIR CLEANER

### Dry Type (1210 Tractor Only)

All engine air used for combustion is filtered by a dry type air cleaner to assure long engine life.

**NOTE:** Left engine side panel must be removed to have access to the air cleaner.

Service the air cleaner element when a loss of power is noticeable. Discard used element and replace with a new one at least once a year.

**Cleaning the element:** The left hand side panel must be removed to obtain access to the air cleaner housing. To clean the element, remove the wing nut and air cleaner cover (See figure 22), remove the element from the back plate. Take care to avoid dislodging accumulated dust on the element into the carburetor inlet. Tap the element lightly on a flat surface for cleaning. Do not water wash or use solvents to clean elements.

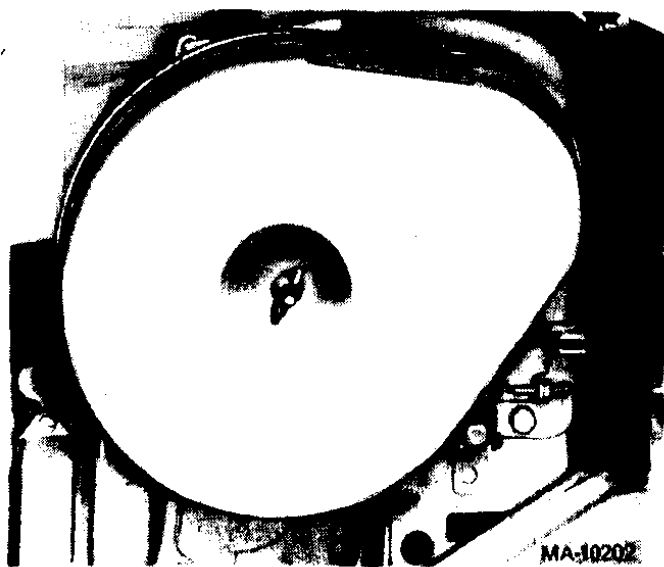

**FIGURE 22.**

**Replacing the element:** If the perforated metal sleeve is dented or the sealing surface damaged, discard and install a new element. When replacing an element, always examine the air cleaner backplate and be sure it is securely tightened to the carburetor. Install a new backplate if the old one is bent or cracked.

Be sure the element fits around the ledge on the backplate before installing air cleaner cover. Replace the cover (rubber gasket must be in place) and tighten the wing nut securely. Do not use pliers—finger tight is adequate. Reinstall the side panel.

Properly cleaned and installed air cleaner elements are the best guarantee to continued long and satisfactory engine life.

#### **Servicing Foam Pre-Cleaner Element (1710, 1711 and 1712 Tractors)**

Clean and re-oil foam pre-cleaner element at 1 month intervals or every 10 hours, whichever occurs first.

**NOTE:** Service more often under dusty conditions.

1. Remove wing nut and cover. See figure 23.
2. Remove foam pre-cleaner element by sliding it up off the paper cartridge.
3. A—Wash pre-cleaner element in liquid detergent and water.  
B—Squeeze dry in cloth.  
C—Saturate in engine oil. Squeeze to distribute oil evenly.  
D—Wrap in shop towel and squeeze to remove excess oil.

Discard used element and replace with new one at least once a year.

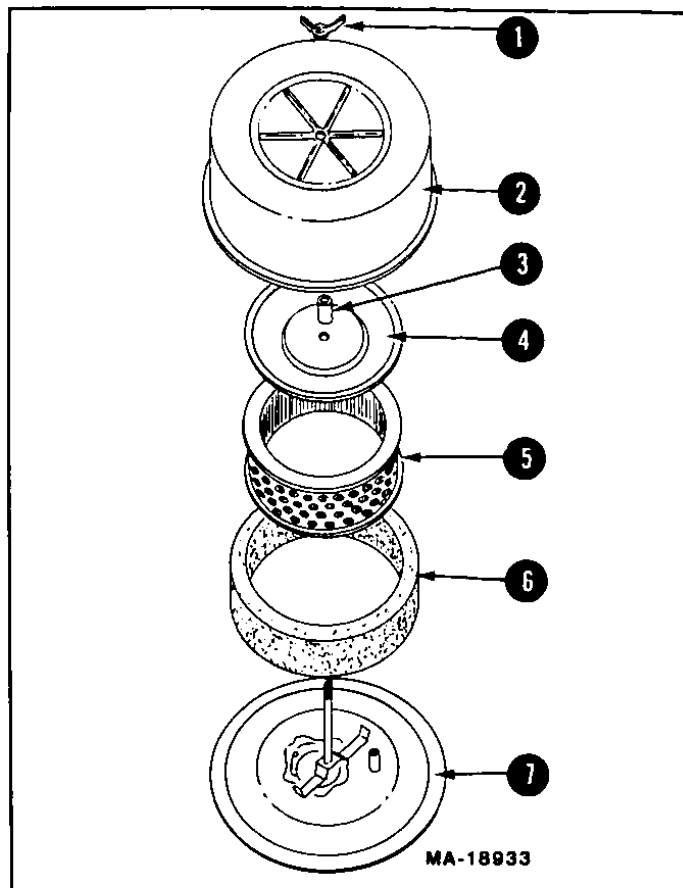

**FIGURE 23.**

- |                |                             |
|----------------|-----------------------------|
| 1. Wing nut    | 5. Paper cartridge          |
| 2. Cover       | 6. Foam pre-cleaner element |
| 3. Rubber tube | 7. Base back plate          |
| 4. Cover plate |                             |

#### **Air cleaner assembly**

#### **Servicing Paper Cartridge**

This engine is equipped with a dry type air cleaner element, which should be checked every 100 operating hours and replaced if dirty. It should be checked and if necessary replaced more often under extremely dirty dusty conditions. Do not wash element in any liquid or attempt to blow dirt off with air hose as this will puncture filter element. Carefully handle new element—do not use if gasket surfaces are bent or twisted. Check the following when installing a new element.

1. Back plate must be flat on gasket of carburetor elbow. Replace back plate if bent or cracked.
2. Gasket surfaces of element must be flat against back plate and cover to seal effectively.
3. Seal on cover must be in place to reduce noise and vibration of the cover. Vibration can cause stud hole in cover to enlarge, thus permitting dirt to enter carburetor.

4. Wing nuts must be finger tight—do not over-tighten.

Properly cleaned and installed air cleaner elements are the best guarantee to continued long and satisfactory engine life.

### CLEANING ENGINE

This tractor has an air-cooled engine. Air must be able to circulate freely around the engine, through the screen, shroud, and over the fins of the cylinder head and cylinder block. Keep these areas free of accumulated dirt and trash or engine will overheat and result in damaged moving parts. **Periodically** clean the inside of the side panels and grille for adequate cooling.

**NOTE:** This machine is designed to cool properly with the engine side panels in place. Operating the machine without panels in place may result in inadequate cooling.

### SPARK PLUGS



A-69529A

FIGURE 24.

**NOTE:** Remove all dirt from around the spark plugs before removing.

To remove spark plugs, always use a spark plug wrench. Check gap after every 100 hours of operation.



### CAUTION

To avoid possible injury, be sure engine is off and cool before making any adjustments or repairs.

Replace a defective plug with a new plug. Set gap at .025-inch (.035-inch for 1210 model). See figure 24. Tighten plug to 10-15 ft-lbs. (and 22 ft-lbs. model 1210). See your authorized dealer for the correct replacement plug.

### Cleaning Spark Plug

Clean spark plugs with a penknife or wire brush and solvent. If electrode is burned away or the porcelain is cracked, replace with new plug.

**NOTE:** Do not sandblast or use any abrasive machines to clean spark plugs; because any grit introduced into the engine could cause severe damage.

### LIGHTS

The headlights are sealed-beam units. Refer to "SPECIFICATIONS" when replacement is necessary.

To replace the taillight lamp, remove socket and bulb from the back of the taillight by rotating socket ¼ turn. Refer to "SPECIFICATIONS".

### FUSES

Always use the same capacity fuse for replacement. Refer to "SPECIFICATIONS." If the lights fail or the electric clutch does not engage, check the appropriate fuse.

To install a new fuse, press in on the fuse housing cap and turn counterclockwise to remove it from the fuse housing. Remove the old fuse and replace it with a new one. Then reassemble the cap to the housing.

**NOTE:** The fuse on the left is for the lights; the fuse on the right is for the electric clutch.

### BATTERY INFORMATION



- A. Battery acid must be handled with great care as contact with it can burn and blister the skin. It is also advisable to wear protective clothing (goggles, rubber gloves and apron) when working with it.\*
- B. Should battery acid accidentally splatter into the eyes or onto the face, rinse the affected area immediately with clean cold water. If there is any further discomfort, seek prompt medical attention.
- C. If acid spills on clothing, first dilute it with clean water, then neutralize with a solution of ammonia/water or baking soda/water.

- D. Since battery acid is corrosive, do not pour it into any sink or drain. Before discarding empty electrolyte containers, rinse them with a neutralizing solution.
- E. NEVER connect or disconnect charger clips to battery while charger is turned on as it can cause sparks.
- F. Keep all lighted materials (cigarettes, matches, lighters) away from the battery as the hydrogen gas generated during charging can be combustible.
- G. As a further precaution, only charge the battery in a well-ventilated area.

**\*Always shield eyes, protect skin and clothing when working near batteries.**



**BATTERIES CONTAIN SULFURIC ACID AND MAY CONTAIN EXPLOSIVE GASES (when electrolyte has been added).**

**KEEP BATTERIES OUT OF THE REACH OF CHILDREN.**

#### **MAINTENANCE OF BATTERY**

1. Check electrolyte level periodically (at least every two weeks). Keep the level to the split rings. Use only distilled water or a good quality drinking water. Never add acid or any other chemicals to the battery after initial activation.
2. The battery should be checked with a hydrometer after every 25 hours of operation. If the specific gravity is less than 1.225, the battery should be recharged. Maximum charge rate 5 AMPS.
3. Coat the terminals and exposed wire with a thin coat of grease or petroleum jelly for longer service and protection against corrosion.
4. The battery should be kept clean. Any deposits of acid should be neutralized with baking soda and water. Be careful not to get this solution in the cells.
5. Avoid tipping the battery. Even a "sealed" battery will leak electrolyte when tipped.

#### **STORAGE OF THE BATTERY**

1. When storing battery for extended periods, disconnect battery cables. Removing battery from unit is recommended.

2. Keep the exterior of the battery clean, especially the top. A dirty battery will discharge itself.
3. Check the battery with a hydrometer. The battery must be stored with a full charge. A discharged battery will freeze.

Specific Gravity	Freezing Point
1.265	-71° F.
1.250	-62° F.
1.200	-16° F.
1.150	5° F.
1.100	16° F.



**NOTE**  
All batteries discharge during storage.

4. Recharge battery whenever the specific gravity is less than 1.225, before returning to service or every two months, whichever comes first.

#### **COMMON CAUSES FOR BATTERY FAILURE**

1. Overcharging
2. Undercharging
3. Lack of water
4. Loose hold downs and/or corroded connections
5. Excessive loads
6. Battery electrolyte substitutes
7. Freezing of electrolyte

**NOTE:** These failures do not constitute warranty.

#### **BATTERY REMOVAL OR INSTALLATION**



When removing the battery, follow this order of disassembly to prevent your wrench from shorting against the frame.

1. Remove the Negative cable.
  2. Remove the Positive cable.
- To install a battery:
1. Attach the Positive cable.
  2. Attach the Negative cable.

#### **JUMP STARTING**

1. Attach the first jumper cable from the Positive terminal of the good battery to the Positive terminal of the dead battery.

2. Attach the second jumper cable from the Negative terminal of the good battery to the FRAME OF THE UNIT WITH THE DEAD BATTERY.



Failure to use this starting procedure could cause sparking, and the gases in either battery could explode.

## TIRES

Keep the pneumatic tires properly inflated. Over-inflation will cause operator discomfort. Under-inflation will cause short tire life.

Inflate the front and rear tires for normal or heavy load operations as shown in the following table.

Tire Size	Pounds per square inch
Front Tires	
16 x 6.50-8	12
Rear Tires	
23 x 10.50-12	10

Always see that the tire valve caps are in place and tightened securely to prevent loss of air and protect the valve core and stem.

Do not overload the tractor tires by mounting equipment on the tractor which exceeds the load capacity of the size of the tires on the tractor.

### Mounting Tires On The Rim

After mounting a new or old tire on the rim, inflate it to 20 pounds pressure to seat the tire bead on the rim flange. Then deflate the tire to the correct operating pressure.

**NOTE:** After the first 10 hours of operation, check and retorque the wheel lug nuts (both sides) to 35 lbf. ft. to make sure they have seated properly.

## OFF-SEASON STORAGE

If the machine is to be inoperative for a period longer than 30 days, the following procedures are recommended:

1. Working outdoors, drain all fuel from the fuel tank. Use a clean dry cloth to absorb the small amount of fuel remaining in the tank, then run the engine until all fuel in the carburetor is exhausted.
2. Drain all the oil from the crankcase (this should be done after the engine has been operated and is still warm) and refill the crankcase with clean new oil.
3. Disconnect the spark plug wires and remove the spark plugs from the cylinders. Pour about 2 or 3 tablespoons of engine oil into each cylinder, and then turn the engine over several times to spread out the oil. Replace the spark plugs but do not connect the wires.
4. Clean the engine and the entire tractor thoroughly.
5. Lubricate all lubrication points and wipe the entire machine with an oiled rag in order to protect the surfaces.
6. Follow battery storage instructions on page 20.
7. Protect tires and seat from sunlight. Inflate tires at regular intervals.

## OPTIONAL EQUIPMENT AND ACCESSORIES

When you purchased your tractor, you probably had it completely equipped for your particular needs at the time. However, later you may wish to obtain optional equipment or accessories. These items and other allied equipment can be purchased from, and installed by, your authorized dealer.

The tractor is used for so many different types of work, and because it is called on to operate under so many different conditions, a variety of equipment is available to adapt it to the requirements of the user. Refer to equipment catalog.

# MAINTENANCE CHART

Operation to be performed	Before each use	10 hours or once a month	30 hours three times a season	50 hours or twice a season	100 hours or yearly	Before storage
Clean grille (front & backside) & engine inlet air screen		More often under dirty conditions X				
Check engine oil level	X					
Fill fuel tank	X					
Change engine oil	After first 5 hours		More often under dirty conditions X			X
Replace transmission oil filter		After first 10 hours X		After first 50 hours X	Every 100 hours there-after	
Re-oil & clean foam air precleaner		X				
Check battery electrolyte level		X				
Grease front axle pivot bolt		X				X
Lubricate steering knuckles (2) and steering arm		X				
Retorque rear wheel lug nuts		After first 10 hours X				
Lubricate brake shaft			X			
Check transmission oil level			X			
Clean cooling fins & external surfaces			X			
Service air cleaner paper cartridge					More often under dirty conditions	
Check spark plugs					X	X
Lubricate steering gear housing					X	
Lubricate speed control linkage cam plates					X	
Check and regrease front wheel bearings					X	X
Drain fuel						X

# TROUBLE SHOOTING

## Possible Cause

## Possible Remedy

### HARD TO START

No gasoline in fuel tank or carburetor .....	Fill the tank with gasoline; open the fuel shut-off valve. Check the fuel line, and carburetor.
Fuel line or carburetor clogged .....	Clean the fuel line and carburetor with commercial carburetor cleaner.
Gas filter plugged .....	Replace.
Water in gasoline .....	Drain the fuel tank and carburetor. Use new fuel and dry the spark plug.
Choked improperly. Flooded engine .....	Follow the starting instructions.
Defective ignition or loose wiring .....	Check the wiring, spark plug, or breaker.
Defective battery .....	Check and service. Refer to "BATTERY".
Spark plug dirty or improper gap .....	Clean, adjust the gap to .025-inch (.035-inch on 1210 model) or replace the plug.

### ENGINE OPERATES IRREGULARLY OR KNOCKS

Engine incorrectly timed .....	*
Spark plug dirty; wrong gap or wrong type .....	Clean, reset the gap, or replace.
Poor or weak spark .....	Check the breaker points and breaker point opening, spark plug, and wiring.*
Carburetor setting incorrect .....	Adjust. Refer to "ADJUSTMENTS".
Poor grade fuel or water in fuel .....	Drain and use a good grade of clean fuel.
Engine overheating .....	Refer to "MAINTENANCE".
Engine valves at fault .....	*
Engine smokes .....	Adjust the carburetor. Check for worn piston and rings.*
Oil level will rise due to gasoline in crankcase .....	Refer to "OPERATING IN COLD WEATHER".
Air filter will become oil and fuel soaked .....	Refer to "OPERATING IN COLD WEATHER".
Engine leaks oil .....	Refer to "OPERATING IN COLD WEATHER".
Mis-firing .....	Refer to "OPERATING IN COLD WEATHER".
Other engine problems .....	*
Excessive oil in air cleaner .....	Be sure that oil dipstick is fully seated and all excess oil is squeezed out of pre-cleaner foam element.

### LACK OF POWER

Air cleaner clogged .....	Service the air cleaner element. Refer to "MAINTENANCE".
Engine overload .....	Reduce the load.
Engine overheated .....	Make sure air intake screen, shrouding, engine fins, and grille are free of accumulated dirt and trash. Refer to "MAINTENANCE".
Poor fuel, too rich, or too lean a mixture .....	Refer to "ADJUSTMENTS".
Fuel tank air vent clogged .....	Open the vent in the cap.
Air leakage between carburetor and engine .....	Remove air cleaner. Tighten the carburetor and manifold mounting nuts. Replace as indicated in "MAINTENANCE".
Incorrect timing or faulty ignition .....	*
Brake drags .....	Adjust the brake. Refer to "ADJUSTMENTS".

\*See your authorized dealer.

## TROUBLE SHOOTING

Possible Cause

Possible Remedy

### ENGINE OVERHEATS

Insufficient cool air, dirty air intake screen, shroud, cooling fins, or dirty grille .....	Keep the air intake area and cooling fins clean; Refer to "MAINTENANCE".
Lean carburetor adjustment .....	Readjust; Refer to "ADJUSTMENTS".
Oil level incorrect .....	Engine oil level must not be over the "FULL" mark or below the "LOW" mark. Refer to "MAINTENANCE".

\*See your authorized dealer.

## LUBRICATION TABLE

Point of Lubrication	Check at Hours	Change at Hours	Capacity	Anticipated Air Temperature		
				Above + 32°F.	+ 32°F. to 0°F.	Below 0°F.
Engine crankcase	Check before each use	30	4 pt. (1210) 3 pt. (1710, 1711 & 1712)	I.H. Low Ash Engine Oil SAE-30 <b>Note:</b> Do not substitute 10W-30 or 10W-40	I.H. Low Ash Engine Oil SAE-10W	I.H. No. 1® Engine Oil SAE-5W-20 or SAE-5W-30
Hydro-drive unit mounted on transmission case with filter	30	Add as needed	14 pt. Approx.	<b>IH Hy - Tran® Fluid</b> If fluid is used which does not meet requirements of IH B-6 Specifications, Cub Cadet will not be responsible for substandard performance. Failures due to use of improper fluid is not covered by warranty. <b>For maximum protection, use IH Hy - Tran® Fluid.</b>		
Steering gear housing	100 or Yearly		¼ lb.	Two strokes of the lubricator using IH-251H EP grease or equivalent No. 2 multi-purpose lithium grease.		
Steering knuckles & front axle pivot bolt	10			Use IH-251H EP grease or equivalent No. 2 multi-purpose lithium grease and apply two or three strokes of the lubricator or sufficient grease to flush out old grease and dirt.		
Front wheel bearings	100 or Yearly			Remove front wheels and pack bearings with IH-251H EP grease or equivalent No. 2 multi-purpose lithium grease and reinstall wheels.		



# LUBRICATION GUIDE

The life of any machine depends upon the care it is given. Proper lubrication is a very important part of that care.

Be certain that all lubrication fittings are assembled in place, using the lubrication illustrations as a guide.

Always lubricate the tractor thoroughly before taking it to the field. Use a pressure lubricating gun.

Be sure all fittings are free from dirt and paint so the lubricant is certain to enter the bearing.

Always force the lubricant through the full length of each bearing until it emerges at the end, carrying with it the worn lubricant and any dirt that may have entered the bearing.

Miscellaneous working parts not provided with lubrication fittings should be oiled daily with a good grade of lubricating oil.

Lubricant is cheap. Use plenty of it. Worn parts can be expensive to replace.

Keep your supply of lubricating oil and grease stored in clean containers, and covered to protect from dust and dirt.

Keep the lubricating gun nozzle clean and wipe dirt from grease fittings before lubricating.

The symbols in the illustration indicate the method of application and the hourly intervals to apply the lubricant.



Use a pressure lubricating gun and apply IH 251H EP grease (or equivalent No. 2 multi-purpose lithium grease) sufficient to flush out the old grease and dirt. Lubricate at hourly intervals indicated on symbols.



Dipstick, use to check engine oil before each use.

# LUBRICATION GUIDE

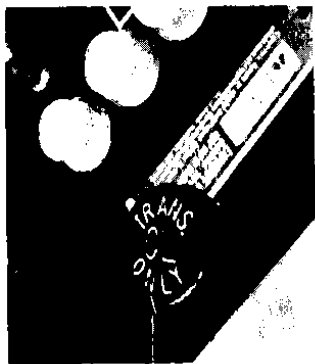

30 6

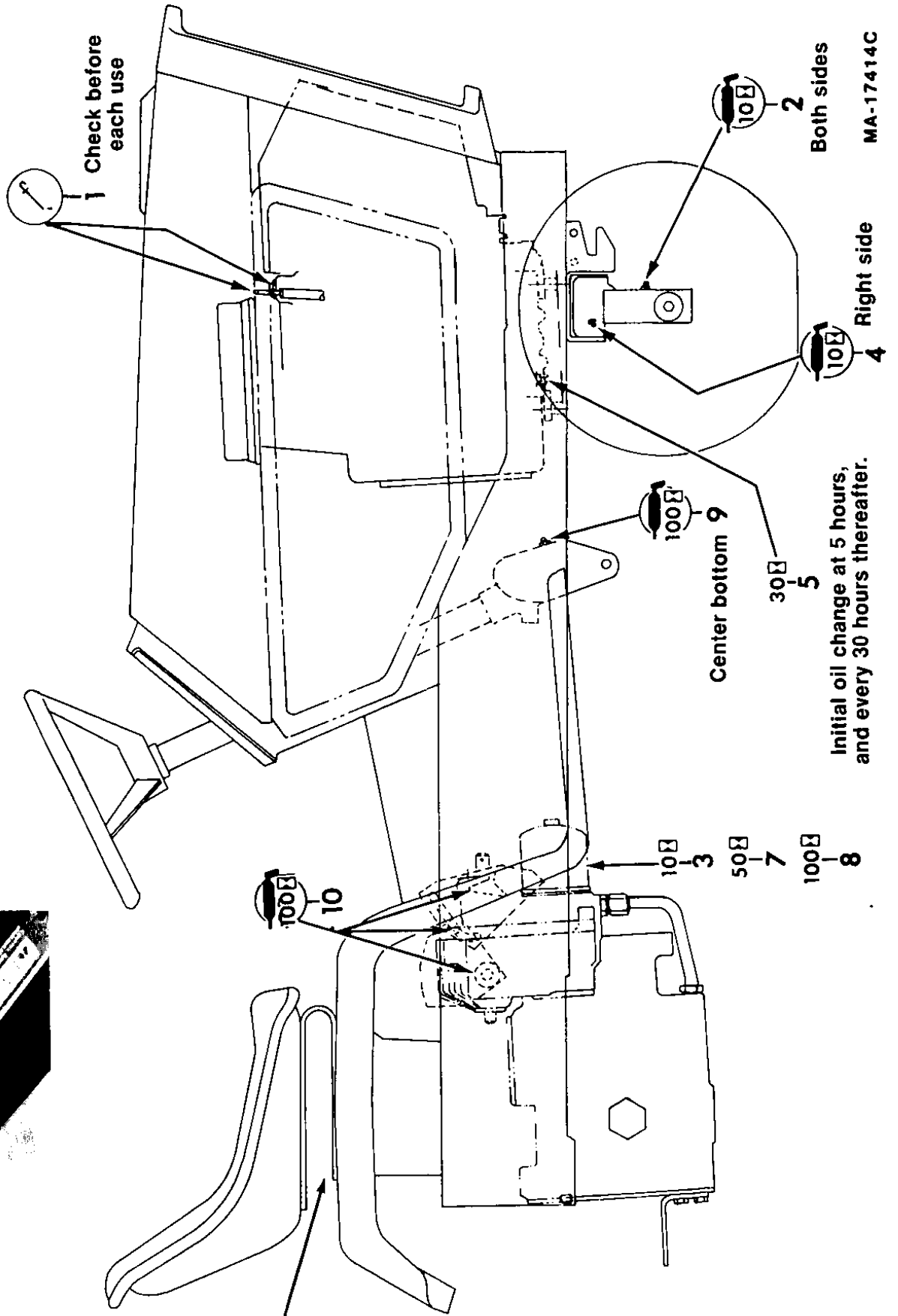

Both sides  
MA-17414C

Right side

Center bottom 9  
Initial oil change at 5 hours,  
and every 30 hours thereafter.

## LUBRICATION GUIDE

### —Before Each Use

- 1—Engine filler cap and dipstick. Check the oil (with the engine stopped) and add sufficient new oil to bring it to the “FULL” mark on the dipstick. Do not overfill. Do not operate the engine if the oil level is below the “LOW” mark on the dipstick.

### —After Every 10 Hours of Operation

- 2—Steering knuckles (2). (Both sides) Use IH 251H EP grease or equivalent No. 2 multi-purpose lithium grease and apply sufficient grease to flush out old grease and dirt.

- 3—Transmission oil filter. **NOTE:** After the first 10 hours only, remove the oil filter and replace with a new filter. Refer to “**MAINTENANCE.**” Change the oil filter after 50 hours and every 100 hours of operation thereafter.

- 4—Front Axle pivot bolt. (Right side) Use IH 251H EP grease or equivalent No. 2 multi-purpose lithium grease and apply sufficient grease to flush out old grease and dirt. **NOTE:** It may be necessary to rotate the front axle to reach the grease fitting.

### —After Every 30 Hours of Operation

- 5—Engine oil drain plug. While the oil is warm, remove the drain plug (5) and drain all of the oil from the crankcase. Replace the drain plug. Refill the crankcase with new oil up to the “FULL” mark on the dipstick. Refer to the “**LUBRICATION TABLE**” for the proper quantity and viscosity to use.

- 6—Transmission oil level and fill tube. Check the oil with the engine stopped. Keep the lubricant up to “FULL” mark on dipstick (6).

### —After Every 50 Hours of Operation

- 7—Transmission oil filter. **NOTE:** After the first 50 hours only, remove the oil filter and replace with a new filter. Refer to “**MAINTENANCE.**” Change the oil filter every 100 hours of operation thereafter.

### —Every 100 Hours of Operation

- 8—Transmission oil filter. Change the oil filter and replace with a new filter. Refer to “**MAINTENANCE.**”

- 9—Steering gear housing. (Center bottom) Once a year, apply two strokes of the lubricator, using IH 251H EP grease or equivalent No. 2 multi-purpose lithium grease.

**NOTE:** To locate the lubrication fitting, turn the front wheels to the maximum right turn position. Then reach up under the right side of the tractor frame to locate the fitting.

### Speed Control Linkage

- 10—Cam plates. Once a year, apply a small amount of IH 251H EP grease or equivalent No. 2 multi-purpose lithium grease in the slots.

### Miscellaneous

- Brake pedal shaft Lubricate the brake pedal shaft and linkage with eight or ten drops of engine oil.

# SPECIFICATIONS

CAPACITIES	1210 Cub Cadet	1710, 1711 and 1712 Cub Cadet
Fuel Tank .....	4 Gals.	
Crankcase .....	4 Pts.	3 Pts.
Transmission case with Hydro-drive unit mounted .....	7 Qts.	
Steering gear housing .....	¼ Lb.	
<b>HYDROSTATIC DRIVE</b>		
Speed: Forward .....	0 to 7.5 mph	
Reverse .....	0 to 4 mph	
<b>ENGINE</b>		
Make and model .....	Kohler	
(electric starting) .....	K301AQS	KT 17
Cylinders .....	1	2
Bore .....	3.38 in.	3.125 in.
Stroke .....	3.25 in.	2.75 in.
Displacement (cubic inches) .....	29.07	42.18
Engine Speed		
(governed)		
Low Speed .....	1800 RPM	1200 RPM
High idle speed		
(no load) .....	3600 RPM	
(full load) .....	3400 RPM	3350 RPM
Valve Clearance		
(engine cold) .....	.008-.010 in. (intake) .017-.020 in. (exh.)	.003-.006 in. (intake) .011-.014 in. (exh.)
Ignition .....	Battery	
Spark plug gap		
(Champion RBL-15Y or equivalent)		
1710, 1711 & 1712 .....	.035 in. gap	.025 in. gap
(Champion RH10 or equivalent) 1210 only .....		
Breaker points .....	.017-.023 in. gap	
<b>ELECTRICAL SYSTEM</b>		
System voltage .....	12 volt neg. ground	
Battery .....	1 HPRLU	
Alternator .....	15 amp	
Fuse (cartridge type) (1 or 2) .....	15 amp slow blow	
Headlights		
all glass, sealed beam units .....	Lamp No. H7610	
Taillight .....	Lamp No. 194	
<b>BRAKES</b>	Dual disc, external	
<b>TIRE SIZES</b>		
Front .....	16 x 6.50-8	
Rear .....	23 x 10.50-12	

Specifications are subject to change without notice.

## SPECIFICATIONS

<b>DIMENSIONS</b>	<b>1210 Cub Cadet</b>	<b>1710, 1711 and 1712 Cub Cadet</b>
Tread:		
Front with 16 x 6.50-8 tires .....		29 in.
Rear with 23 x 10.50-12 tires .....		27 in.
Wheelbase .....		44 in.
Length, over-all .....		72 in.
Width, over-all .....		37.75 in.
Height, over-all (to top of steering wheel) .....		43 in.
Ground clearance .....		6 in.
Turning radius .....		6.8 ft.

**Specifications are subject to change without notice.**





