

**INTERNATIONAL®
CUB CADET®
782—DIESEL
TRACTOR**

INTERNATIONAL®

OPERATOR'S MANUAL



To The Owner

BE SURE THIS OPERATOR'S MANUAL IS KEPT WITH THIS MACHINE AT ALL TIMES, REGARDLESS OF OWNERSHIP.

Assembled in this manual are operation, lubrication, and maintenance instructions for the Cub Cadet 782-D Tractor. The material has been prepared in detail to help you better understand the correct care and efficient operation of your tractor. Before you operate the tractor, study this manual carefully. Additional copies may be ordered from your dealer at a nominal price.

Your local authorized dealer is interested in the performance you receive from your tractor. He has factory-trained servicemen, informed in the latest method of servicing tractors, modern tools, and original-equipment service parts which assure proper fit and good performance.

The Cub Cadet 782-D Tractor has a hydrostatic drive transmission. It is the best hydrostatic drive unit available and will require minimum service if

recommended operation and maintenance procedures are followed.

To obtain top performance and assure economical operation the tractor should be inspected, depending on its use, periodically, or at least once a year, by your authorized dealer.

When in need of parts, always specify the model, chassis, and engine serial numbers, including the prefix and suffix letters. Write these serial numbers in the space provided.

Should you have difficulties with the unit consult your authorized dealer. **UNDER NO CIRCUMSTANCES SHOULD YOU ATTEMPT TO SERVICE THESE UNITS YOURSELF.** Only your dealer is authorized to repair or replace components under the terms of the warranty. Should you desire additional information not found in this manual, contact your authorized Cub Cadet dealer.

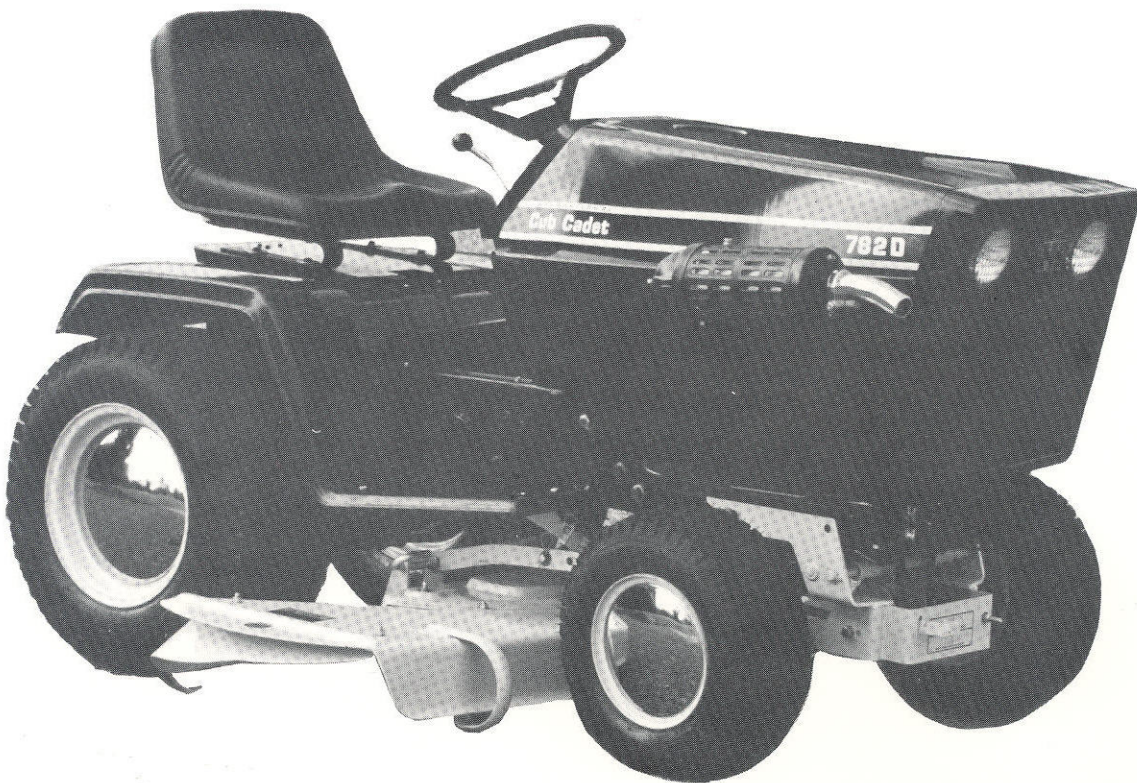

**Tractor Equipped with
Optional 44" Mower Deck**

CONTENTS

To The Owner	Inside Front Cover	Off-Season Storage	21
Serial No. Location	1	Optional Equipment and Accessories	21
Safe Operations	2 & 3	Maintenance Chart	22
Controls	4 & 5	Trouble Shooting	23 & 24
Operation	7	Specifications	25
Adjustments	11	Lubrication Table	26
Maintenance	14	Lubrication Guide	27 & 28

SERIAL NUMBER LOCATION

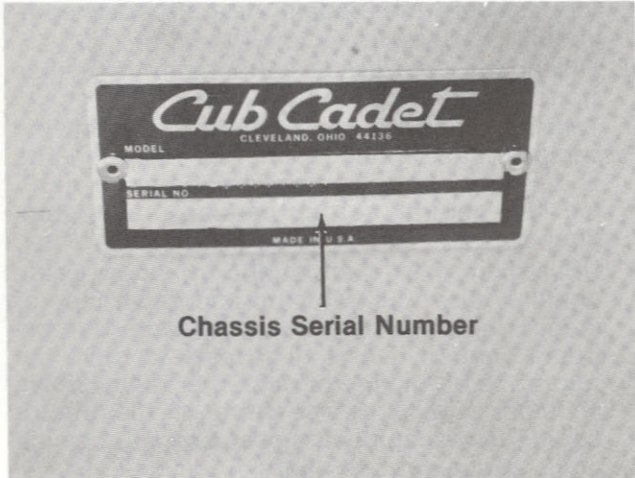

FIGURE 1.

Serial number plate is located left hand side frame. See figure 1.

NOTE: LEFT and RIGHT indicate the left and right sides of the tractor when facing forward in the

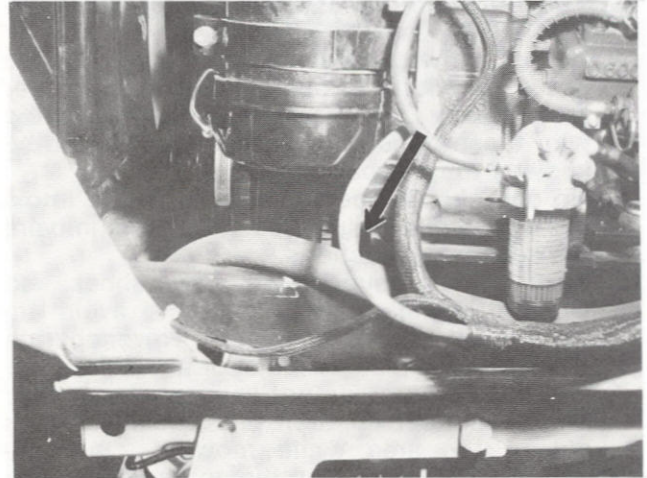

FIGURE 2.

driver's seat. Reference to FRONT indicates the grille end of the tractor; to REAR the drawbar end. Engine serial number plate is located on the left hand, forward part of engine at engine mounting plate. See figure 2.

CHASSIS S/N _____

ENGINE S/N _____

MODEL _____

DELIVERY DATE _____



This unit is equipped with an internal combustion engine and should not be used on or near any unimproved forest-covered, brush-covered or grass-covered land unless the engine's exhaust system is equipped with a spark arrester meeting applicable local or state laws (if any). If a spark arrester is used, it should be maintained in effective working order by the operator.

In the State of California the above is required by law (Section 4442 of the California Public Resources Code). Other states may have similar laws. Federal laws apply on federal lands.

WORK SAFELY — FOLLOW THESE RULES



Instructions given with this symbol are for personal safety. Be sure you and your workers follow them.

A CAREFUL OPERATOR IS THE BEST INSURANCE AGAINST AN ACCIDENT

1. Read this owner's manual carefully in its entirety before attempting to assemble or operate this unit. Keep this manual in a safe place for future and regular reference.
2. This unit is a precision piece of power equipment, not a plaything. Therefore exercise extreme caution at all times.
3. Know the controls and how to stop quickly—**READ THIS OWNER'S MANUAL.**
4. Do not allow children to operate vehicle. Do not allow adults to operate it without proper instruction. Only persons well acquainted with these rules of safe operation should be allowed to use your tractor.
5. No one should operate this unit while intoxicated or while taking medication that impairs the senses or reactions.
6. Wear sturdy, rough-soled work shoes and close-fitting slacks and shirts to avoid entanglement in the moving parts. Never operate a unit in bare feet, sandals, or sneakers.
7. To prevent injury, do not carry passengers or give rides. Keep children, pets and bystanders out of the area while mowing. Only the operator should ride on the unit and only ride in the seat.
8. Check overhead clearance carefully before driving under power lines, guy wires, bridges or low hanging tree branches, before entering or leaving buildings, or in any other situation where the operator may be struck or pulled from the unit, which could result in serious injury.
9. To maintain control of the unit and reduce the possibility of upset or collision, operate the tractor smoothly. Avoid erratic operation and excessive speed.
10. Keep the area of operation clear of all persons, particularly small children and pets. Stop engine when they are in the vicinity of your tractor. Although the area of operation should be completely cleared of foreign objects, a small object may have been overlooked and could be accidentally thrown by the mower in any direction and cause injury.
11. Clear work area of objects which might be picked up and thrown by the mower in any direction and cause injury.
12. Stop the blade(s) when crossing gravel drives, walks or roads.
13. Disengage all attachment clutches and shift into neutral before attempting to start engine.
14. Disengage power to attachment(s) and stop engine before leaving operating position.
15. Do not put hands or feet near or under rotating parts. Keep clear of the discharge opening at all times as the rotating blade(s) can cause injury.
16. Disengage power to attachment(s) and stop engine before making any repairs or adjustments.
17. Before attempting to unclog the mower or discharge chute, stop the engine. The mower blade(s) may continue to rotate for a few seconds after the engine is shut off. Therefore, be sure the blade(s) have stopped completely.
18. Disengage power to attachment(s) when transporting or not in use.
19. Take all possible precautions when leaving vehicle unattended such as disengaging power-take-off, lowering attachments, shifting into neutral, setting parking brake, stopping engine and removing key.
20. Do not stop or start suddenly when going uphill or downhill. Mow up and down face of steep slopes; never across the face. Use extreme caution if it is necessary to drive the tractor up an incline or back the tractor down an incline because the front of the tractor could lift and rapidly flip over backward which could cause serious injury.
21. Reduce speed on slopes and in sharp turns to prevent tipping or loss of control. Always keep the tractor in gear when going down steep hills to take advantage of engine braking action.
22. Stay alert for holes in terrain and other hidden hazards.
23. Use care when pulling loads or using heavy equipment.
 - A. Use only approved drawbar hitch points.
 - B. Limit loads to those you can safely control.
 - C. Do not turn sharply. Use care when backing.
 - D. Use counterweight(s) or wheel weights when suggested in owner's manual.
24. Watch out for traffic when crossing or near roadways.
25. When using any attachments, never direct discharge of material toward bystanders nor allow anyone near vehicle while in operation.
26. Handle fuel with care. It is highly flammable.
 - A. Use approved fuel container.
 - B. Never remove cap or add fuel to a running or hot engine or fill fuel tank indoors. Wipe up spilled fuel.
 - C. Open doors if engine is run in garage. Exhaust fumes are dangerous. Do not run engine indoors.
27. Keep the vehicle and attachments in good operating condition, and keep safety devices in place. Use guards as instructed in operator's manual.

28. Keep all nuts, bolts, and screws tight to be sure the equipment is in safe working condition.
29. Never store the equipment with fuel in the tank inside a building where fumes may reach an open flame or spark. Allow engine to cool before storing in any enclosure.
30. To reduce fire hazard, keep engine free of grass, leaves or excessive grease.
31. The vehicle and attachments should be stopped and inspected for damage after striking a foreign object. The damage should be repaired before restarting and operating the equipment.
32. Do not change the engine governor settings or overspeed the engine.
33. When using the vehicle with mower, proceed as follows:
 - (1) Mow only in daylight or in good artificial light.
 - (2) Never make a cutting height adjustment while engine is running if operator must dismount to do so.
- (3) Shut the engine off and wait until the blade comes to a complete stop before removing the grass catcher.
- (4) Check blade mounting bolts for proper tightness at frequent intervals.
34. Look behind to make sure the area is clear before placing the transmission in reverse and continue looking behind while backing up. Disengage blades before shifting into reverse and backing up.
35. This unit **should not** be driven up a ramp onto a trailer or truck under power, because the unit could tip over, causing serious personal injury. The unit must be pushed manually to load properly.

PRODUCT GRAPHICS

Keep safety product graphics (decals) clean. Replace any safety product graphic that is damaged, destroyed, missing, painted over or can no longer be read. Replacement safety product graphics are available through your International Harvester dealer.



CAUTION

RECEIVE INSTRUCTION—Read operator's manual. Learn to operate this machine SAFELY. Don't risk INJURY or DEATH.

1. Before starting engine or operation:
Be familiar with controls. Be in operator's position with transmission in neutral, PTO turned off, and brake depressed.
2. Keep Shields in place. Keep away from moving parts.
3. **NO RIDERS!** Keep all people and pets a safe distance away.
4. Don't point mower discharge at people.
5. Avoid slopes. Tractors can be rolled over.
6. Before leaving operator's position:
Shut off PTO. Place transmission in neutral. Set parking brake. Shut off engine. Remove ignition key. Wait for all movement to stop before servicing or cleaning.
7. Do not fill fuel tank when engine is running. Tighten cap securely.



CAUTION

Electrical system is 12 volt negative ground. When using booster with jumper cables, precautions must be taken to prevent personal injury or damage to electrical parts.

1. Attach one end of jumper cable to positive terminal of booster battery and other end to positive terminal of vehicle battery.
2. Attach one end of second cable to negative terminal of booster battery and other end to vehicle frame away from battery. Do not attach to cab or cab support.
3. To remove cables, reverse above sequence exactly to avoid sparks. See operator's manual for additional information.

CAUTION—BOOSTER BATTERY INSTRUCTIONS LOCATED UNDER THE HOOD.

GENERAL SAFETY INSTRUCTIONS CAUTION LOCATED ON THE DASH.



CAUTION

HOT SURFACE - DO NOT TOUCH

CAUTION—MUFFLER LABEL LOCATED ON THE MUFFLER.

CONTROLS

Your Cub Cadet Tractor has been safety engineered. Thoroughly acquaint yourself with all the instruments and controls before attempting to start or operate the tractor.

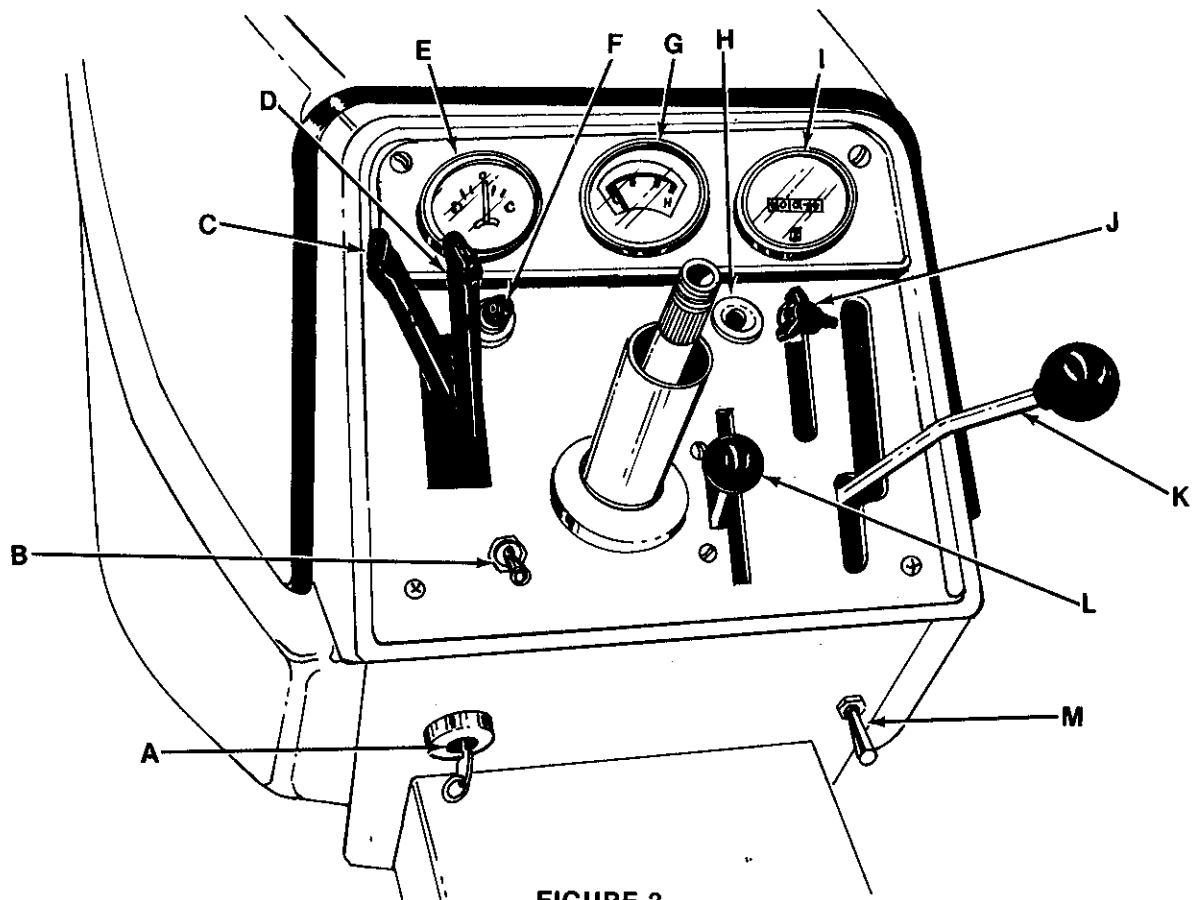

FIGURE 3.

- A. Ignition Switch
- B. Front Power Take-Off (PTO)
- C. Hydraulic Lift Control Lever
- D. Front Hydraulic Outlet Control Lever
- E. Charge Indicator
- F. Engine Oil Light (Red)
- G. Water Temperature Gauge
- H. Glo-Plug Indicator
- I. Hour Meter
- J. Speed Control Stop
- K. Speed Control
- L. Throttle Control and Fuel Shut-Off Lever.
- M. Light Switch

A. IGNITION SWITCH

The ignition switch is a four position switch. Turn key to glo-plug position until glo-plug indicator is red (for required time, see operating section of this manual). Turn key to start position when engine starts, release key. Key will retract to on position. See figure 3.



Remove the key from the tractor when the tractor is not in use to prevent accidental starting and battery discharge.

NOTE: Under certain conditions it is possible for a Diesel Engine to start and run in a reverse condition.

Reversed engine revolution and remedies

Reversed engine revolution must be stopped immediately since engine oil circulation is cut quickly leading to serious engine trouble.

How to tell when the engine starts running backwards

1. Lubricating oil pressure drops sharply. Oil pressure warning light will light, and remain on.

2. Since the intake and exhaust side are reversed, the sound of the engine changes, and exhaust gas will come out of the air cleaner.
3. A louder knocking sound will be heard when the engine starts running backward.

Remedies

1. Immediately set the engine throttle to off position, to stop the engine.
2. After stopping the engine, check the air cleaner, intake rubber tube and other parts and replace parts as needed.

B. FRONT POWER TAKE-OFF (PTO)

The front power take-off is an electric clutch operated by a toggle switch on the left side of the instrument panel. See figure 3.

C. HYDRAULIC LIFT CONTROL LEVER

HYDRAULIC LIFT

The hydraulic lift is ready to operate when the engine is running.

The hydraulic lift control lever is spring loaded, for hold position. To raise the equipment move the lever back, toward the tractor seat. To lower the equipment move the lever forward.

D. FRONT HYDRAULIC OUTLET CONTROL LEVER

The front hydraulic outlet control lever provides for "on-the-go" angling of a front mounted blade. See figure 3.

E. CHARGE INDICATOR

This instrument indicates whether the alternator is charging or the battery is discharging. If it shows discharge continuously, investigate the cause to avoid completely discharging the battery and possible damage to the charging circuit. See figure 3.

F. ENGINE OIL LIGHT (RED)

The engine oil light will light up when the ignition key is held in the glo-plug position for starting, and when the engine oil is low or no oil pressure. See figure 3.

G. WATER TEMPERATURE GAUGE

This gauge is used to indicate engine coolant temperature and possible overheating of engine. See figure 3.

H. GLO-PLUG INDICATOR

The glo-plug is used to assist cold starting. See figure 3.

I. HOUR METER

The hour meter is located on the instrument panel. See figure 3. It indicates the actual hours of engine operation, enabling the operator to determine without guesswork, when lubrication, change of oil or periodic inspections are necessary. The hour meter operates whenever the engine is running or the ignition key is in the "ON" position.

J. SPEED CONTROL STOP

An adjustable speed control stop is provided to allow the operator to return to a predetermined speed. See figure 3.

K. SPEED CONTROL

The lever is used to select any speed from a standstill "N" position to eight miles per hour in the forward direction and to four miles per hour in the reverse direction.

Moving the speed control lever forward provides increased forward speed, and moving the lever rearward from the neutral position provides the reverse speeds. Refer to figure 3.

NOTE: Do not rest your foot on the brake pedal while driving the tractor as this will cause the speed control lever to return to the "N" position.

L. THROTTLE CONTROL AND FUEL SHUT-OFF LEVER

This lever controls the speed of the engine and fuel turn-on/shut-off. When set in a given position, it will maintain a uniform engine speed. See figure 3.

When using power take-off operated equipment, best performance is achieved with the throttle lever in the "FAST" position.



This symbol shows slow position.



This symbol shows fast position.

M. LIGHT SWITCH

The lights are turned on and off by a toggle switch on the lower right hand side of instrument panel. See figure 3. Flip switch up for on, down for off.

BRAKE PEDAL

Brake pedal must be pressed all the way down to activate the safety starting switch. When brake pedal is in the depressed position it automatically moves the speed control lever to the "N" position.

The tractor can be stopped either by pressing the pedal all the way down, or placing the speed control lever in the "N" position.

LOCKING THE BRAKE

Always lock the brake when the tractor is parked on a grade. To lock the brake, press down on the pedal; then place the brake pedal lock in the engaged position. See figure 4. To disengage the lock, press down on the pedal, lift the lock up and place it in the disengaged position.

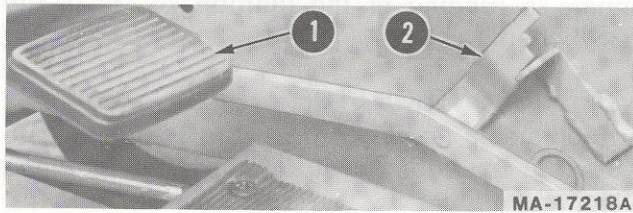

FIGURE 4.

1. Brake pedal
2. Brake pedal lock



The hydrostatic transmission will not hold the tractor on a hill. In a short period of time (depending on the hill) the oil pressure will drop in the transmission and allow the tractor to roll down hill. To avoid an accident and/or possible injury, lock the brake.

INTERLOCKS (Not Shown)

Interlock safety switches are located at and activated by the clutch-brake pedal, the PTO switch and the seat.

The safety starting switches activated by the brake pedal and the power take-off clutch switch serve to prevent starting the engine accidentally. The clutch-brake pedal must be depressed and the PTO switch in the "OFF" position before engine will start.

When using PTO operated equipment, the operator must remain in tractor seat at all times. If operator should leave tractor seat without turning off the PTO switch, the PTO will automatically shut off. In addition, the PTO switch must be in the "OFF" position when shifting tractor into reverse or the PTO will shut off automatically. To re-engage the PTO, shift unit into neutral. Move PTO switch to the "OFF" position and then move PTO switch to "ON" position.

POSITION STOP FOR HYDRAULIC LIFT

The cam stop may be adjusted to allow the implement to return to a preset height. See figure 5.

With implement in desired lowered height position, release cam stop by turning locking knob

counterclockwise. Turn cam stop until it contacts lift bracket. Lock cam stop into this position by turning cam knob clockwise.

NOTE: Refer to the equipment manual for proper hitching instructions.

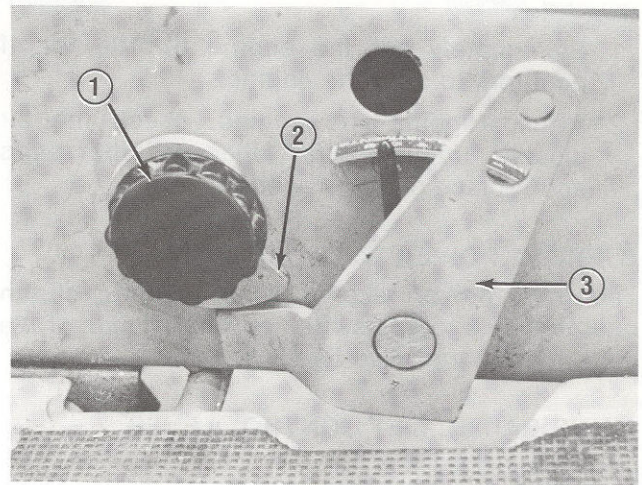

FIGURE 5.

1. Locking knob
2. Cam stop
3. Rockshaft arm

Equipment is normally operated in a "Float" position (implement free to move upward).

To operate equipment in a fixed "Locked" position, where down pressure of the implement is required (blade work), remove frame cover and install bolt, 1/2 x 1-1/8-inch, (not furnished with tractor) between the lift arm and lift bracket. See figure 6.

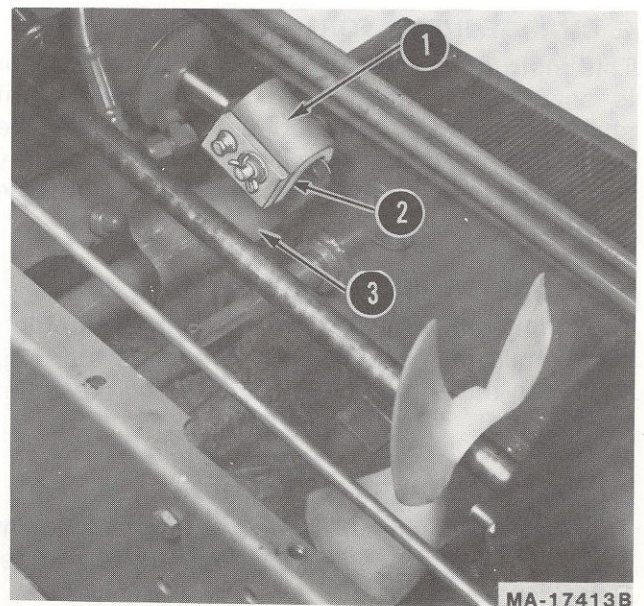

FIGURE 6.

1. Lift bracket
2. Hole (not seen) for bolt
3. Lift arm

FUEL TANK

The fuel tank is located under the seat. See figure 7.

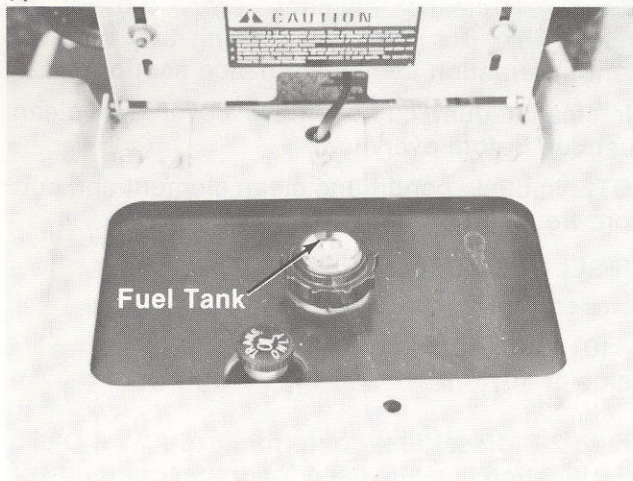

FIGURE 7.

HOOD AND NOISE ISOLATION PANELS

The tractor hood is arranged to swing up and forward for easy access to the engine compartment. The hood locks automatically when raised. To lower hood, release latch on left side by gently pushing hood up to release tension and pull latch to left. See figure 8. Also, whenever engine maintenance is required, the noise isolation panels can be readily removed by removing the two wing nuts and two washers (one on each side) and disconnecting the panel spring.

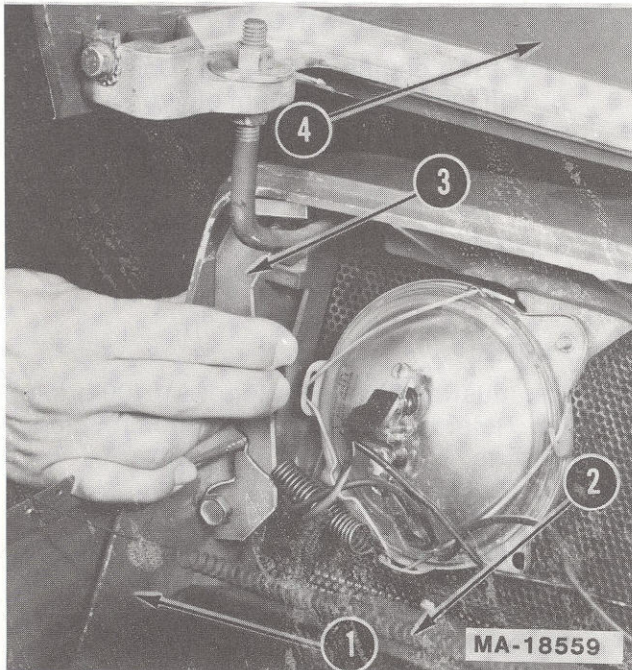

FIGURE 8.

1. Noise isolation panel (one on each side)
2. Panel spring
3. Latch
4. Hood

OPERATION

PRE-OPERATION CHECKLIST

1. Check Oil Level
2. Check Radiator Coolant Level
3. Check Air Cleaner Dust Cup
4. Clean Radiator Screen
5. Fill Fuel Tank with Diesel Fuel
6. Check Transmission Fluid Level

ENGINE OIL REQUIREMENTS

RECOMMENDED OIL

Ambient Temperature	Viscosity (Grade CD)
Above 77°F	SAE 30
32°F to 77°F	SAE 20 or 15W-40
Below 32°F	SAE 10 or 10W-40

DO NOT USE: Synthetic oil, non-detergent oil or other non-recommended oils.

DO NOT MIX different brands of oil.

ENGINE OIL CAPACITY—98.4 oz. (6.2 pints) including oil in oil filter.

OIL CHANGE INTERVALS

	OIL	OIL FILTER
Initial Change	35 hrs.	35 hrs.
Normal Change	100 hrs.	100 hrs.

OIL DIPSTICK CHECKS

Dipstick should be checked before starting the unit **EVERY TIME**.

Dipstick markings indicate upper and lower limits at a cold oil condition.

Never overfill engine oil.

RADIATOR COOLANT MIXTURE

Total Coolant—2/3 gallon (6 pints)

Coolant Consists of 50-50 mixture—3 pints water, 3 pints anti-freeze (ethylene glycol)

NOTE: Water and anti-freeze must be mixed prior to filling radiator.

RADIATOR SCREEN

Radiator screen must be cleaned before each use and kept free of debris.

NOTE: Radiator screen must be cleaned more frequently in dusty and high grass cutting conditions. This is to prevent overheating of the engine.

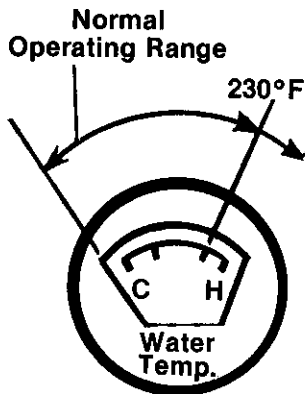

CAUTION: Readings above 230°F can indicate possible overheating of engine. If overheating occurs, vapor can be seen coming from overflow tube.

Check The Following:

1. Radiator Screen
2. Coolant Level



WARNING

Turn the radiator cap slowly counter-clockwise to the pressure release point to allow the pressure or any steam to escape; then press down on the cap and continue to turn until the cap is free to be removed.

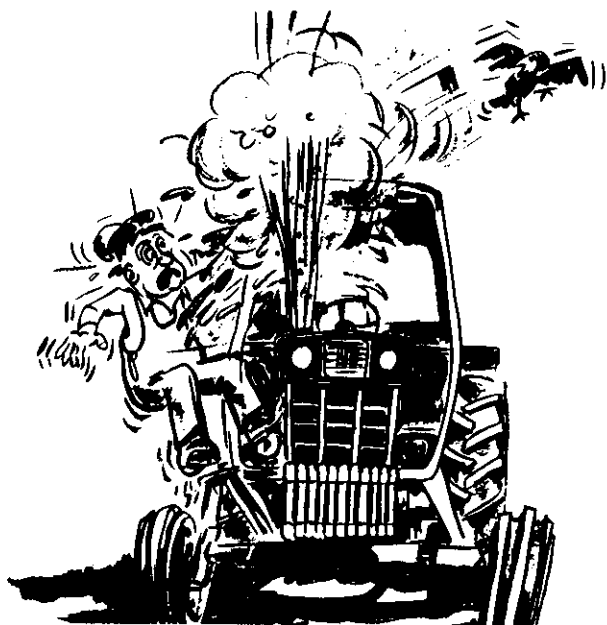

CAUTION

Pressure cooling system—REMOVE CAP SLOWLY.

GLO-PLUG INSTRUCTIONS

Ambient Temperature	Preheating Time
Higher Than 86°F	Approx. 10 Sec.
Between 86°F and 50°F	Approx. 15 Sec.
Between 50°F and 32°F	Approx. 20 Sec.
Between 32°F and 0°F	Approx. 30 Sec.
Below 0°F	Approx. 45 Sec.

AIR CLEANER MAINTENANCE

Clean air cleaner element—every 100 hrs.

Change air cleaner element—every 400 hrs. or once a year (for element cleaning and replacement information see maintenance section).

Air cleaner dust cup—remove cover and clean dust cup before every use.

NOTE: In dusty conditions clean element and cup more frequently.

DIESEL FUEL REQUIREMENTS

Temperature	Type
+ 10°F and Above	#2-D
Below + 10°F	#1-D

Grade 2-D diesel fuel conforming to ASTM D-975 specification must be used for proper operation of these tractors. Grade 1-D diesel fuel may be used at temperatures below +10°F (-12.2°C) or for operations entailing considerable idling. Use only winter grade fuel for ease of starting. Winter grade diesel fuel must have a cloud point of at least 10°F (6°C) below the lowest anticipated temperature to avoid plugging of the fuel circulation system, especially the fuel filters.

NOTE: Type #1-D and #2-D diesel fuels must have a cetane rating of 45 and above.

Fuel tank capacity—approx. 4 gallons.

WARNING

Never run engine out of fuel. Doing so will require fuel system bleeding. (See maintenance section.)

TRANSMISSION FLUID

Transmission Fluid—IH Hy Tran Only

Transmission Fluid Capacity—13 Pints

FUEL FILTER

Fuel filter must be cleaned after every 100 hrs. of operation. Refer to maintenance section for cleaning procedure.



WARNING

Explosion hazard. Do not use starting aids such as gasoline or ether in the air intake.

ATTENTION

Engine warm up at idle speed for approximately 5 minutes is recommended before operating unit.



CAUTION

RECEIVE INSTRUCTION-Read operator's manual. Learn to operate this machine SAFELY. Don't risk INJURY or DEATH.

1. Before starting engine or operation:
Be familiar with controls.
Be in operator's position with transmission in neutral, PTO turned off, and brake depressed.
2. Keep shields in place. Keep away from moving parts.
3. **NO RIDERS!** Keep all people and pets a safe distance away. Look before backing up.
4. Don't point mower discharge at people.
5. Avoid slopes. Tractors can be rolled over.
6. Before leaving operator's position:
Shut off PTO. Place transmission in neutral. Set parking brake. Shut off engine. Remove ignition key. Wait for all movement to stop before servicing or cleaning.
7. Do not fill fuel tank when engine is running or while engine is hot. Tighten cap securely.

2. Familiarize yourself with the operation of all the instruments and controls.
3. Fill the fuel tank with clean, fresh, diesel fuel. See figure 9. Tank is located under the seat.

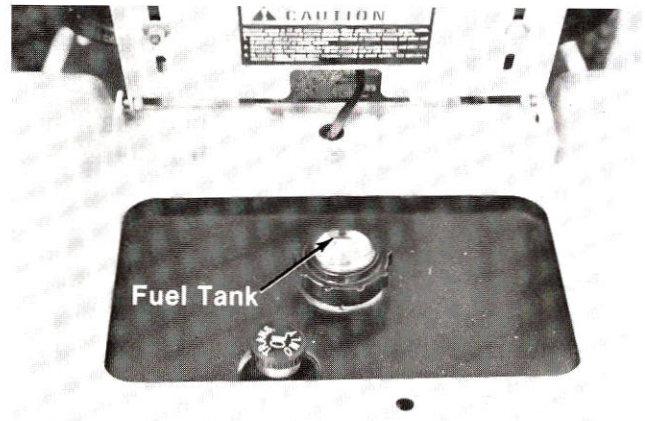

FIGURE 9.

4. Check the tire inflation pressures.
5. Adjust the seat for operator's maximum comfort, visibility, and complete control of the tractor.
6. Make certain that the grille is clean and unobstructed. Pull forward on top edge to expose rear side of grille. Remove by hand any accumulated grass and debris.
7. Refer to various sections of the operator's manual for additional information.

ENGINE COOLANT HEATER (Optional)

At temperatures below freezing, it may be necessary to use an engine coolant heater as a starting aid.

An engine heater is available, to warm the engine coolant, as a starting aid during cold weather. It is located on the left side of the engine and requires a 3 wire extension cord and a 120 volt AC grounded outlet for safe operation.

After engine starts, be sure to disconnect extension cord before moving tractor.



CAUTION

Connecting heater to power source before it is immersed in coolant may result in **EXPLOSION** and **INJURY**. Always be sure that the element is immersed in coolant before connecting to power source.

BEFORE OPERATING YOUR TRACTOR

1. Before you operate the tractor study this manual carefully. It has been prepared to help you operate and maintain your tractor with utmost efficiency.

STARTING THE ENGINE

NOTE: This unit is equipped with a safety interlock system for your protection. The purpose of the safety interlock system is to prevent the engine from cranking or starting unless the brake pedal is depressed and the PTO switch is in the off position. In addition, the PTO lever must be in the off position when the unit is put into reverse or the PTO will shut off. Operator must remain in the seat when the PTO is on or the PTO will shut off.



Do not operate the tractor if the interlock system is malfunctioning because it is a safety device, designed for your protection.

TO START

1. Before starting engine run through pre-operation checklist (located inside hood). Be familiar with controls. Be in operator's position with transmission speed control in neutral; PTO switch off and brake depressed.

2. Move throttle control forward to start position (never start engine at full throttle).
3. Turn key to glo-plug position until glo-plug indicator is red (for required time, see instructions inside hood). Note: if engine is warm, step 3 may be bypassed. (See figure 10.)
4. Turn key to start position. When engine starts, release key. Key will retract to on position.
5. Throttle should remain in start position (idle) for approximately 5 minutes for proper engine warm up.

TO SHUT OFF

1. Return transmission speed control lever to neutral, depress brake. Return PTO to off position.
2. Move throttle to start position (idle) for approximately (1) minute.
3. Move throttle to off position.
4. Turn key to off position and remove. Note: Key will not turn off engine.



FIGURE 10.



CAUTION

During operation do not run the engine in confined area such as storage building. Immediately move the tractor outside of the building.



WARNING

Exhaust fumes can kill. Never run engine inside buildings.

DRIVING THE TRACTOR

1. Depress the standard brake pedal, release the brake lock, and let the pedal up. Move the throttle lever to the position where the engine operates best for the load to be handled.
2. Start the tractor in motion by moving the speed control lever slowly forward or rearward to desired speed.



CAUTION

Avoid sudden starts, excessive speed, sudden stops. Keep vehicle in gear when going down hills.

NOTE: When using power take-off operated equipment, best performance is achieved with the throttle lever in the "FAST" position.

Always be sure the rear wheels are free to turn. Under any adverse conditions, do not attempt to free the tractor by speeding up the engine and suddenly moving speed control lever to extreme forward or reverse position. Try backing out instead of going forward.

Do not leave the seat of the tractor without depressing the brake pedal and setting the brake lock. If leaving the tractor unattended, stop engine by moving throttle to off position, also turn the ignition key off and remove the key.

DRIVING ON SLOPES

Before operating the tractor on any slope, walk the slope to look for possible hazards such as rocks, mounds, ruts, stumps or other surface irregularities which could cause an upset.

Back the tractor with implement up the steepest portion of each slope you intend to work. If the tractor cannot negotiate the slope in reverse, the slope is too steep to be worked.



CAUTION

Always operate up or down the face of a slope. Do not drive so that the tractor may tip over sideways.

Avoid turns when driving on a slope. If a turn must be made, turn down the slope. Turning up a slope greatly increases the chance of a roll over.

Avoid stopping when driving up a slope. If it is necessary to stop while driving up a slope, start up smoothly and carefully to reduce the possibility of flipping the tractor over backward.

STOPPING THE TRACTOR

Move the speed control lever to the "N" position or use the standard brake pedal. Before dismounting always lock the brake pedal, stop engine by moving throttle to off position, and turn ignition "OFF." Also disengage the power take-off control switch.



CAUTION

Always engage brake pedal lock, lower equipment and shut off engine before dismounting. Never start engine from ground.

OPERATING THE FRONT POWER TAKE-OFF CLUTCH (PTO)

1. Move the throttle lever back to the medium or "SLOW" position.
2. Flip the toggle switch to the "ON" position. See figure 11.

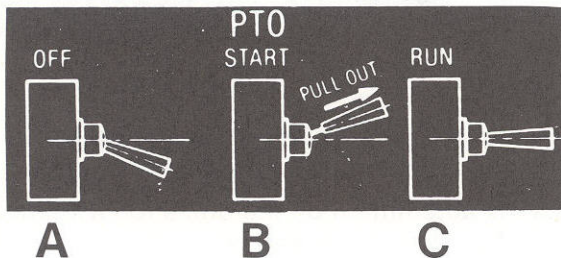

FIGURE 11.

- A. PTO switch must be in off position before starting unit and before shifting tractor into reverse.
 - B. To start the front PTO, pull knob out and lift up (Note: Knob will retract into run position).
 - C. Position at which PTO will run if starting procedure has been completed. (Note: If PTO is running and unit is shifted into reverse or operator leaves the seat, the PTO will disengage. To reactivate PTO, pull knob out and lift up into start position.)
3. Advance throttle to operating speed (full speed).
 4. The operator must remain in tractor seat at all times. If operator should leave tractor seat without turning off the power take-off switch, the PTO will automatically shut off.
 5. PTO switch must be in the "OFF" position when shifting the tractor into reverse or the PTO will shut off automatically. To re-engage the PTO, shift unit into neutral. Move PTO switch to "OFF" position and then move PTO switch to "ON" position.

ADJUSTMENTS

ADJUSTING THE SEAT

Before starting the tractor, adjust the seat to the most comfortable driving position. Tilt the seat forward over the steering wheel, loosen the four bolts in the seat support, and slide the seat assembly forward or rearward to the position which is most comfortable for the operator. See figure 12.

Retighten the four bolts after the seat is repositioned.

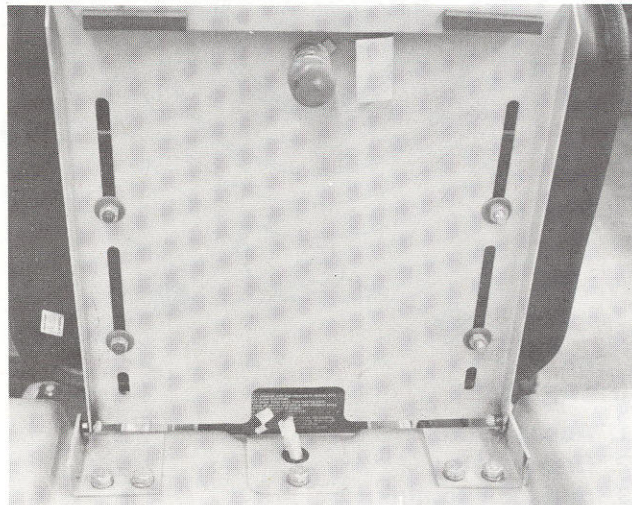

FIGURE 12.

ADJUSTING THE POWER TAKE-OFF CLUTCH

The clutch is factory adjusted and should not require further adjustment under normal operating conditions. However, if the clutch fails to operate properly check as follows:

Check circuit breaker located on right side of battery tray.



CAUTION

To avoid possible injury, always disengage all clutches, move speed control lever into neutral, depress the brake, set the brake pedal lock, move throttle to off position, and turn the ignition "OFF" before working on the machine.

Using a feeler gauge, check the air gap. See figure 13. Insert feeler gauge into one of three access slots located around the outside of the brake plate. The air gap should be .010-.015-inches. Adjust the self-locking nuts to obtain the proper clearance. Repeat the operation in all three access slots.

NOTE: If brake plate drags on clutch at .010-.015-inches air gap, increase air gap to .020-inches.

If the above procedure does not work, see your authorized dealer.

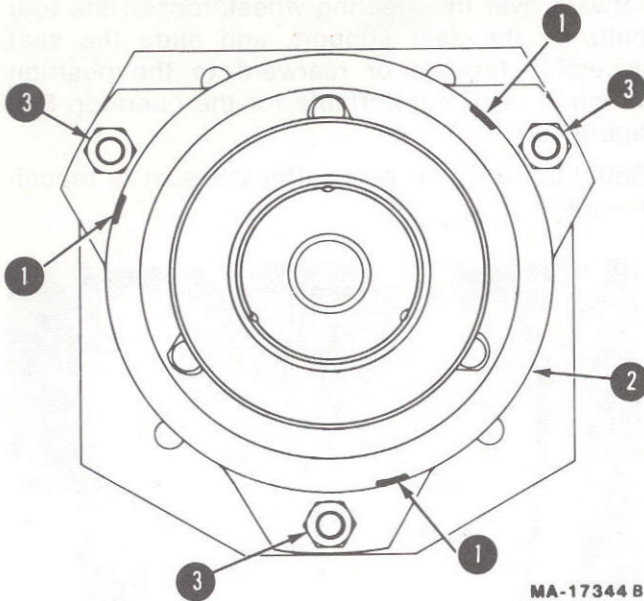

FIGURE 13.

1. Access slots
2. Brake plate
3. Self-locking nuts

ADJUSTING THE BRAKES

During normal operation of this machine, the brakes are subject to wear and will require periodic examination and adjustment.

With the brake pedal disengaged, remove the clevis pinned end of one of the brake rod assemblies from the jackshaft assembly by removing the cotter pin from the clevis pin. See figure 14.

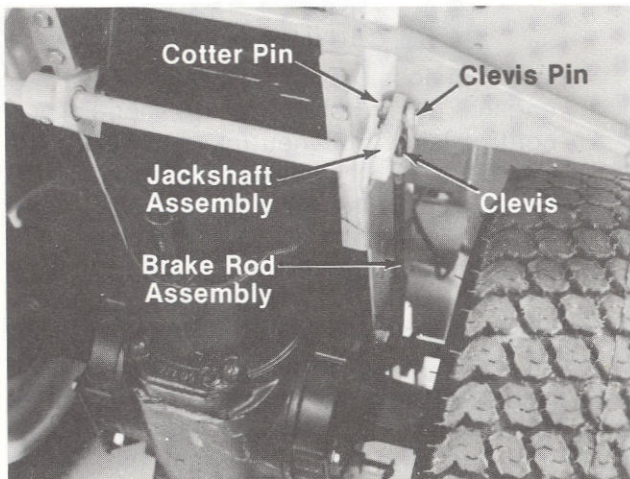

FIGURE 14.

Thread the clevis onto the brake rod one turn. Reconnect the clevis to the jackshaft assembly. There should be a minimum amount of clearance (no drag) between the brake pads and the rotor. See figure 15. If not, repeat adjustment as necessary.

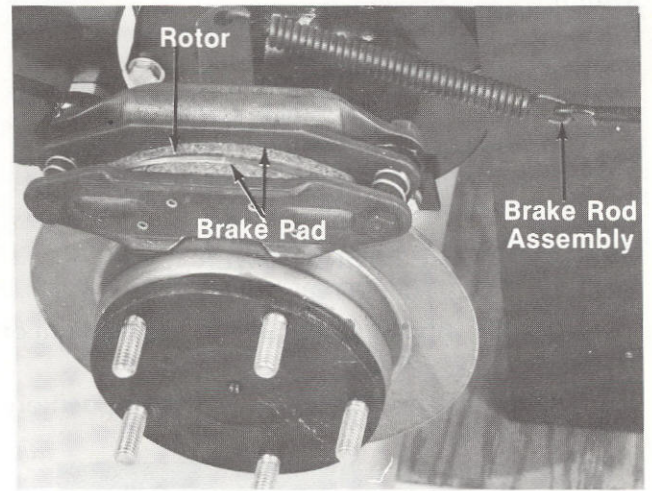

FIGURE 15.

NOTE: Figure 15 is shown with the wheel and fender assembly removed for clarity.

Repeat the adjustment on the brake rod assembly on the other side of the tractor.

Recheck brake adjustment and insure proper brake operation before operating the tractor.

WHEEL ALIGNMENT

The front wheels should toe-in approximately 1/8". Measure the distances A and B on the front wheels. See figure 16.

NOTE: Dimension B should be approximately 1/8 inch less than dimension A.

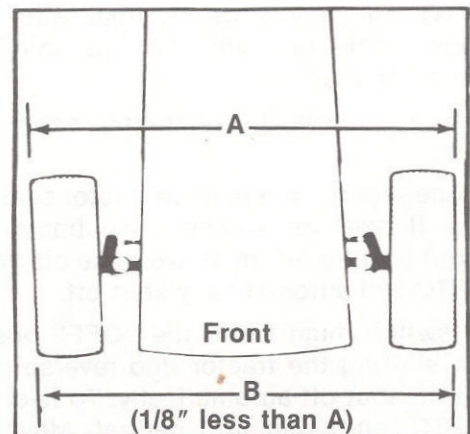

FIGURE 16.

Front wheel adjustments.

To adjust the toe-in remove one ball joint, loosen the lock nut "C" at the ball joint and turn the tie rod ball joint in or out as required.

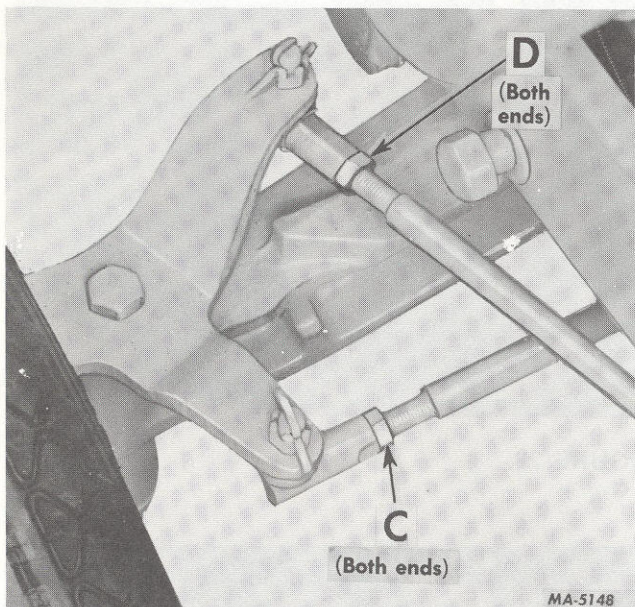

FIGURE 17.
Tie rod and drag link ball joints.

TURNING RADIUS

The front wheels should have an equal angle for left and right turns. If adjustment is necessary, remove ball joint and loosen lock nut "D", turn the drag link ball joint clockwise or counterclockwise as required. See figure 17.



CAUTION

Be sure all parts are reassembled tight with cotter pins in place and spread.

FAN AND GENERATOR BELT Fan Belt Tension and Damage

An improperly adjusted fan belt can cause engine overheating. Push on the fan belt at the middle with a finger, and check that it deflects about 0.4 in. (10mm) [at a load of 22.1 lb. (10kg)]. Also check the belt for cracks or tears.

Tension Adjustment Generator Belt (See figure 18.)

Loosen the two bolts holding the generator, and adjust until proper tension is obtained. Be sure to retighten the nuts and bolts after adjustment.

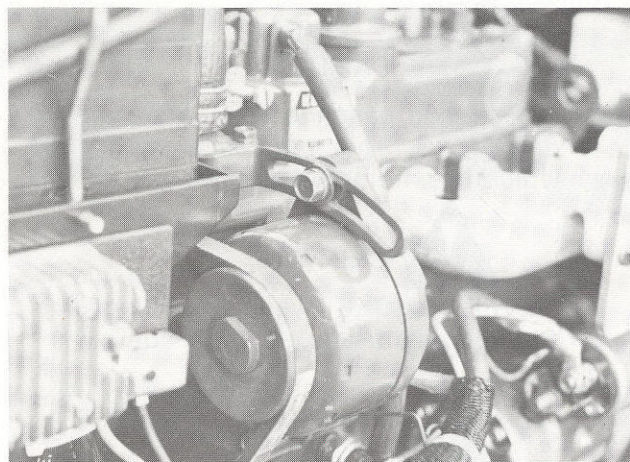

FIGURE 18.

Tension Adjustment Fan Belt (See figure 19.)

Loosen two hex bolts. Insert 3/8" drive ratchet wrench at top square hole. Apply pressure, and while applying pressure retighten two bolts.

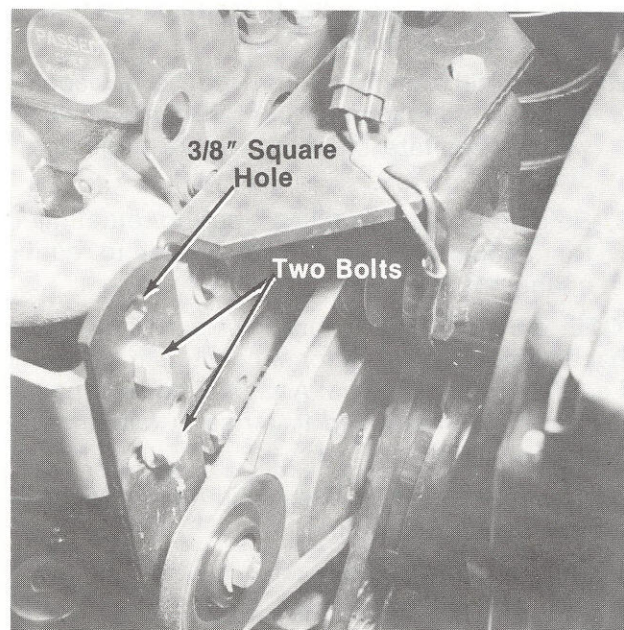

FIGURE 19.

MAINTENANCE

FUEL

Fuel Level Check and Refueling

For fuel, always use diesel light oil. You are required not to use alternative fuel, because its quality is unknown or it may be inferior in quality. Do not use kerosene, which is very low in cetane rating, and adversely affects the engine.

See page 8 on fuel required.



CAUTION

Do not add gasoline or alcohol to diesel fuel. This creates a vapor which is extremely explosive.



CAUTION

NEVER SMOKE while refueling. Shut off engine and electrical equipment.



CAUTION

Never remove the fuel tank cap or fill the fuel tank near an open flame. Do not smoke when working around inflammable fuel.



IMPORTANT

1. Be sure to use a strainer when filling the fuel tank. Dirt or sand in the fuel will cause fuel injection pump failure.
2. Be careful not to let the fuel tank become empty, or air can enter the fuel system, which will necessitate bleeding before engine will start.
3. Be careful not to spill fuel during refueling. If fuel should spill, wipe it off at once to reduce chance of a fire.

NOTE: Do not fill the tank to its full capacity. Space is required for vapor expansion in the event of a temperature change. A tank filled to capacity may overflow if exposed to a rise in temperature or direct sunlight.

Be sure that the filler cap is tightened securely before starting the engine.

Bleeding the Fuel System

Bleeding the fuel system is required:

1. after the fuel filter and lines have been detached and refitted;
2. after the fuel tank has become empty;
3. before the tractor is to be used after long storage.

PROCEDURE

1. Fill the fuel tank. Open the fuel shut-off valve. See figures 20 and 21.
2. Loosen air vent plugs of the fuel filter a few turns.
3. Turn ignition key switch to "ON" position to activate fuel pump.

4. Retighten screw plugs when air bubbles do not appear anymore.
5. Turn ignition key to "OFF" position.

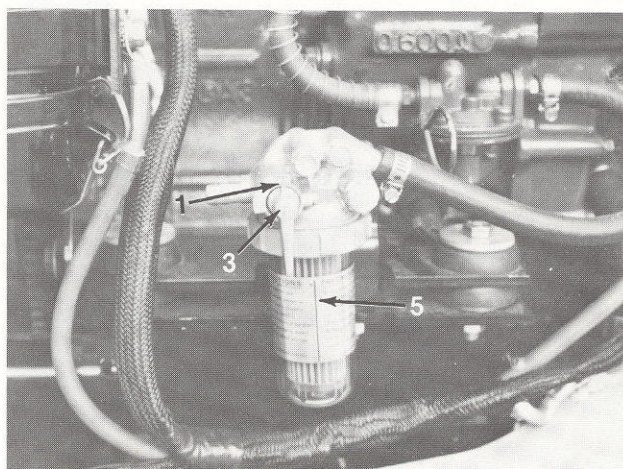

FIGURE 20.

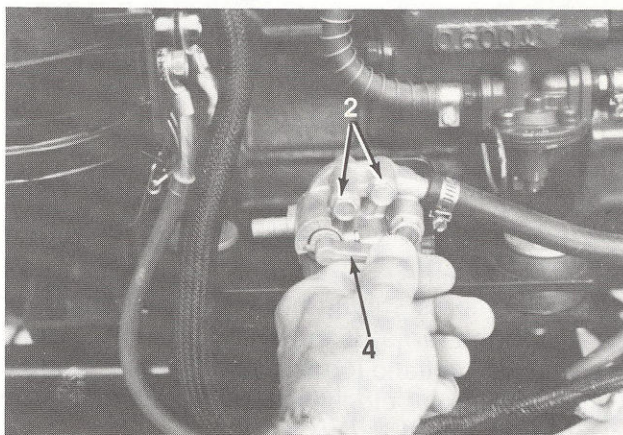

FIGURE 21.

1. Fuel shut-off valve
2. Air vent plugs
3. "ON"
4. "OFF"
5. Fuel filter bowl

WARRANTY NOTICE

The warranty on these engines and/or power train components shall not apply to any failure that results from an unauthorized adjustment of the fuel injection system.

Any attempt to increase the engine horsepower by increasing engine r.p.m. above its rated maximum, or by other means, not only affects traveling speeds but affects the life of matching parts and voids the company responsibility as outlined in the warranty.

INJECTION PUMP (Air Bleeding)

If the engine will not start after bleeding the fuel pump, bleed the air further in the system, as follows.

1. Loosen the air vent plug. See figure 22.
2. Turn ignition key switch to "ON" position to activate fuel pump.
3. Tighten the air vent plug.

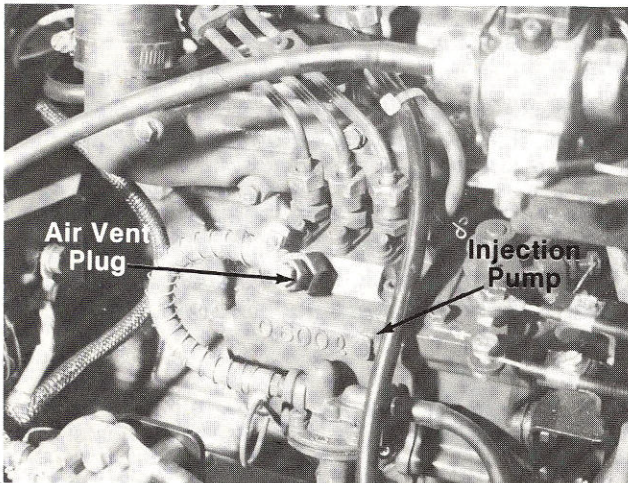

FIGURE 22.

▶ IMPORTANT

Always keep the air vent plug on the fuel injection pump closed except when bleeding system, or it may cause the engine to stop.

Checking the Fuel Lines

Check the fuel lines every 50 hours of operation.

1. The fuel lines deteriorate regardless of amount of use of tractor.
2. Replacement of fuel lines are recommended every 2 years. If the fuel lines and clamps are found worn or damaged before two years, replace or repair immediately.
3. After replacement of the lines and clamps, bleed the fuel system.



CAUTION

Check or replace the fuel lines only after stopping the engine. Broken fuel lines can cause fires.

▶ IMPORTANT

When the fuel lines are disconnected, plug them at both ends with clean cloth or paper to prevent dirt from entering the lines. Dirt in the lines can cause fuel injection pump malfunction.

Cleaning the Fuel Filter Bowl

Clean the fuel filter every 100 hours.

This should not be done in the field, but in a clean place so as to prevent dust intrusion.

1. Close the fuel filter bowl shut-off valve. See figures 20 and 21.
2. Unscrew and remove the top cap, and rinse with kerosene.
3. Take out the element and rinse in kerosene.
4. After cleaning, reassemble the fuel filter, keeping out dust and dirt.
5. Bleed the injection pump.

▶ IMPORTANT

If dust and dirt enter the fuel, the fuel pump and injection nozzle are subject to quick wear. To prevent this, be sure to clean the fuel filter bowl periodically.

ENGINE OIL

Checking Level and Adding Engine Oil

See figures 23 and 24.

1. Check the engine oil level before starting the engine or after five minutes once it has been stopped.
2. Remove the dipstick, wipe it clean, reinsert it, take it out again, and check the oil level. Oil level should be between the two marks at lower end of dipstick.
3. If the oil level is low, remove the oil port fill plug, and add new oil to the prescribed level.

If the engine is operated with the oil level nearing the lower mark, however, oil may deteriorate quickly. Keeping the oil level near the upper mark is recommended (never over fill).

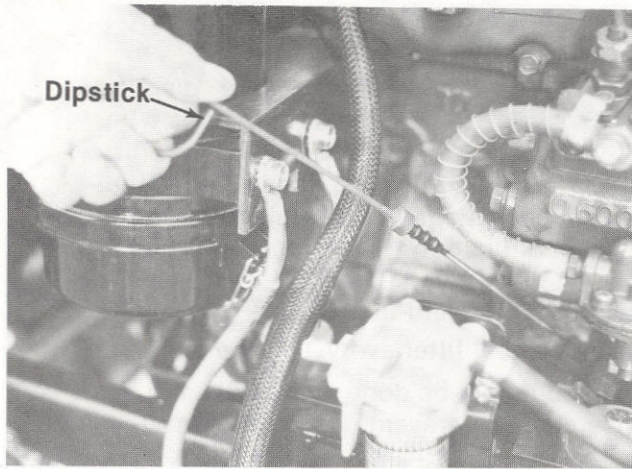

FIGURE 23.

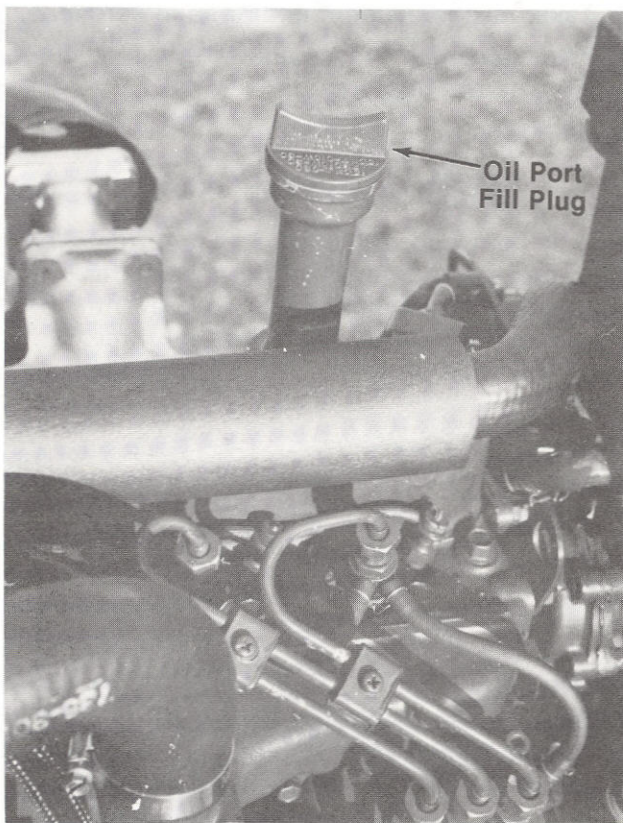

FIGURE 24.

Changing Engine Oil

1. Remove the drain plug at the bottom of the engine, and drain all the old oil. Draining oil will be easier and complete if done while the engine is still warm.
2. Replace drain plug and add new engine oil up to the upper mark of the dipstick.
3. Engine should be started, run briefly, stopped and oil level rechecked.



CAUTION

Change engine oil only after stopping the engine.

Replacing the Oil Filter Cartridge (See figure 25)

1. Replace the oil filter cartridge every 100 hours of operation, when engine oil is changed.
2. Remove the oil filter cartridge with a filter wrench.
3. Apply a film of oil to the gasket of the new cartridge.
4. Screw in the cartridge by hand. When the gasket comes into contact with the seal surface, tighten the cartridge an additional $\frac{1}{2}$ turn by hand.
5. After the cartridge has been replaced, the engine oil level drops. Thus, run the engine for a while and check for oil leaks around the seal. Recheck the engine oil level. Add oil if necessary.



CAUTION

Stop the engine before replacing the oil filter cartridge.



IMPORTANT

Wipe off any excess oil.

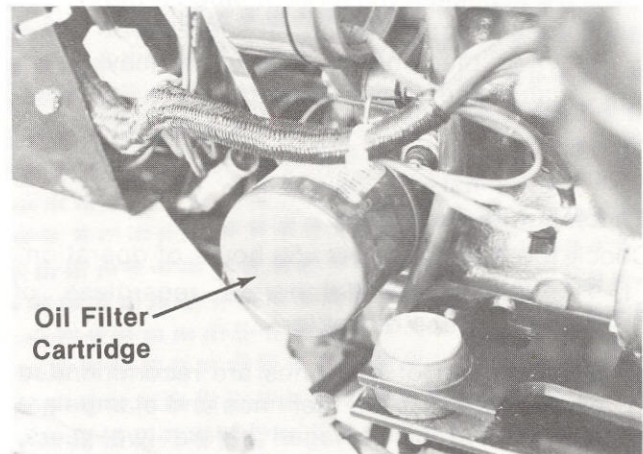

FIGURE 25.

RECOMMENDED OIL

Ambient Temperature

Above 77°F
32°F to 77°F
Below 32°F

Viscosity (Grade CD)

SAE 30
SAE 20 or 15W-40
SAE 10 or 10W-40

DO NOT USE: Synthetic oil, non-detergent oil or other non-recommended oils.

DO NOT MIX different brands of oil.

ENGINE OIL CAPACITY—98.4 oz. (approx. 6.2 pts.) including oil in oil filter.

OIL CHANGE INTERVALS

	OIL	OIL FILTER
Initial Change	35 Hrs.	35 Hrs.
Normal Change	100 Hrs.	100 Hrs.

ENGINE OIL LEVEL CHECKS

Engine oil level should be checked before starting the unit **every time**.

Dipstick markings indicate upper and lower limits at a cold oil condition.

Never overfill engine oil.

RADIATOR AND COOLANT

Make it a rule to check the coolant level before every operation.



CAUTION

It is dangerous to remove the radiator pressure cap when the system is hot. Allow the system to cool and remove the cap cautiously.

Checking Level, Adding and Changing Coolant See figure 26.

1. Remove the radiator pressure cap, and check to see if water reaches the supply port.
2. In the event of insufficient coolant, fill the radiator with proper coolant. In addition, check two drain cocks at the lower part of the radiator and the side of the crankcase to see if they are securely closed.

Tractors shipped in the United States and Canada have the cooling systems filled with antifreeze solution.

Hot Weather Operation

We recommend the use of water with the addition of I.H. cooling system conditioner. The boiling point of ethylene glycol solution is higher than water, but the ability to transfer heat is less. As a result, the engine will run cooler with conditioned water.

Other than Hot Weather Operation

We recommend the use of I.H. antifreeze with a mixture ratio to protect the coolant to the lowest anticipated temperature or a minimum of 33 percent antifreeze for rust and corrosion protection.

IMPORTANT

1. Never use dirty or salt water as coolant.
2. Be sure to tighten the radiator pressure cap securely after checking coolant.
3. When coolant is added, coolant level may drop the first time the engine is started. After operating tractor briefly, allow system to cool and recheck coolant level.

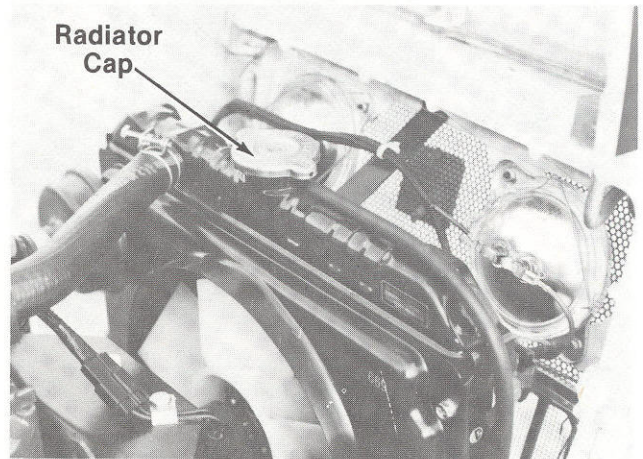

FIGURE 26.

4. To drain coolant, always open both coolant cocks located at the crankcase side and at the lower part of the radiator; simultaneously open the radiator cap as well. With the cap tightly closed, a complete drain of coolant is impossible.

RADIATOR COOLANT MIXTURE

Total coolant— $\frac{3}{4}$ U.S. gallon (6 pints).

Coolant consists of 50-50 mixture—3 pints water, 3 pints antifreeze (ethylene glycol).

NOTE: Water and antifreeze must be mixed prior to filling radiator.

AIR CLEANER

See figures 27, 28, 29 and 30.

1. The element of the air cleaner on this engine is a dry type. Never apply oil to it.
2. Remove and clean out the dust cup every day if the working surroundings are dusty. Never allow dust cup to become half full with dust.
3. Avoid disassembling the element except when cleaning.
4. To clean the element, use clean dry compressed air on the inside of the element.

Air pressure at the nozzle must not exceed 690 kPa (7 kgf/cm², 100 psi).

Maintain reasonable distance between the nozzle and the filter.

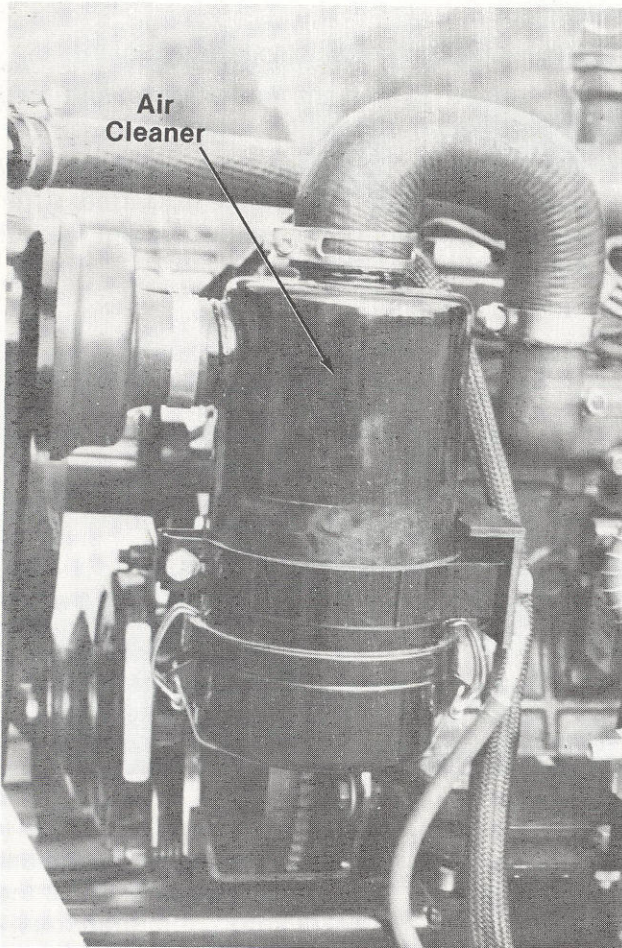

FIGURE 27.

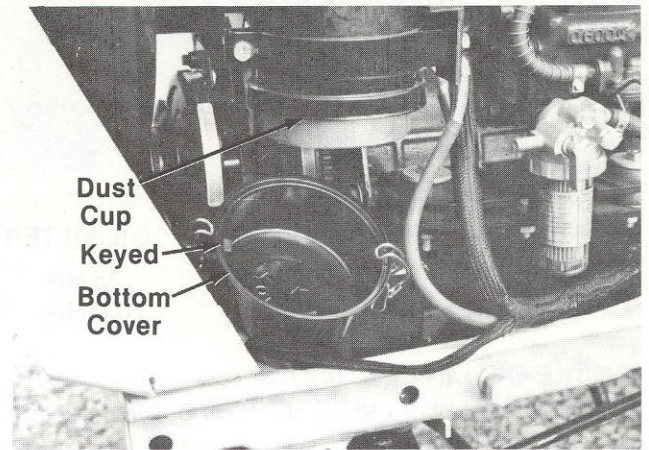

FIGURE 28.

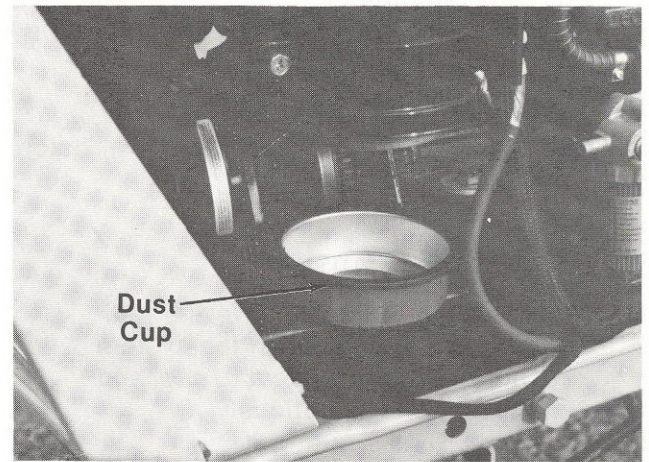

FIGURE 29.

5. When carbon or oil adheres to the element, soak the element in a mixture of 2 oz. detergent dissolved in 1 gallon of water for 15 minutes, then wash it several times in water, rinse with clean water and air dry completely. After element is fully dried, inspect inside of the element with a light and check if it is damaged. (Refer to the instruction on the label attached to the element.)
6. Replace the element every year or after every six cleanings.



IMPORTANT

Install the bottom cover with the keyed edged towards the front of tractor.

If the dust cup is mounted incorrectly, dust or dirt does not collect in the cup, and dust will cause severe engine damage.

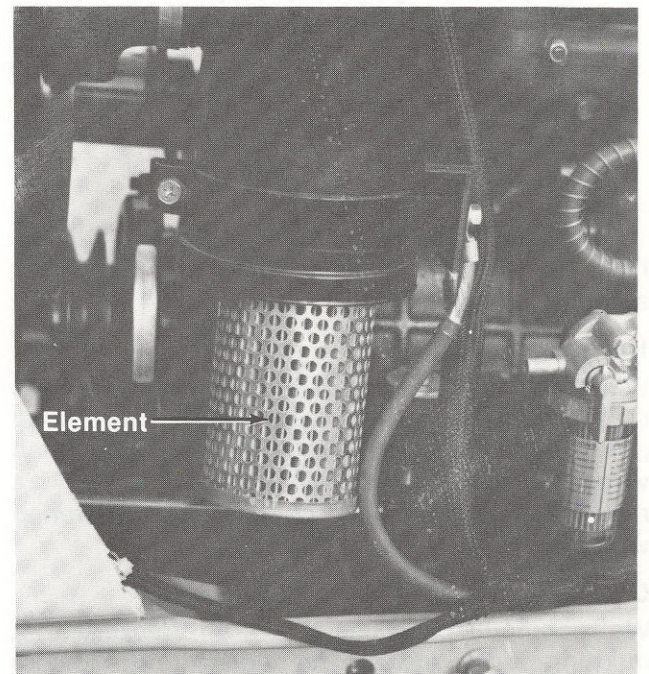

FIGURE 30.

BATTERY INFORMATION



WARNING

- A. Battery acid must be handled with great care as contact with it can burn and blister the skin. It is also advisable to wear protective clothing (goggles, rubber gloves and apron) when working with it.*
 - B. Should battery acid accidentally splatter into the eyes or onto the face, rinse the affected area immediately with clean cold water, and seek prompt medical attention.
 - C. If acid spills on clothing, first dilute it with clean water, then neutralize with a solution of ammonia/water or baking soda/water.
 - D. Since battery acid is corrosive, do not pour it into any sink or drain. Before discarding empty electrolyte containers, rinse them with a neutralizing solution.
 - E. NEVER connect or disconnect charger clips to battery while charger is turned on as it can cause sparks.
 - F. Keep all lighted materials (cigarettes, matches, lighters) away from the battery as the hydrogen gas generated during charging can be combustible.
 - G. As a further precaution, only charge the battery in a well-ventilated area.
- * Always shield eyes, protect skin and clothing when working near batteries.

DANGER

BATTERIES CONTAIN SULFURIC ACID AND MAY CONTAIN EXPLOSIVE GASES (when electrolyte has been added).

KEEP BATTERIES OUT OF THE REACH OF CHILDREN.

MAINTENANCE OF BATTERY

1. Check electrolyte level periodically. Keep the level to the split rings. Use only distilled water. Never add acid or any other chemicals to the battery after initial activation.
2. The battery should be checked with a hydrometer after every 25 hours of operation. If the specific gravity is less than 1.225, the battery should be recharged. Maximum charge rate 5 AMPS.
3. Coat the terminals and exposed wire with a thin coat of grease or petroleum jelly for longer service and protection against corrosion.

4. The battery should be kept clean. Any deposits of acid should be neutralized with baking soda and water. Be careful not to get this solution in the cells.
5. Avoid tipping the battery. Even a "sealed" battery will leak electrolyte when tipped.

STORAGE OF THE BATTERY

1. When storing battery for extended periods, disconnect battery cables. Removing battery from unit is recommended.
2. Keep the exterior of the battery clean, especially the top. A dirty battery will discharge itself.
3. Check the battery with a hydrometer. The battery must be stored with a full charge. A discharged battery will freeze.

Specific Gravity	Freezing Point
1.265	-71° F.
1.250	-62° F.
1.200	-16° F.
1.150	5° F.
1.100	16° F.



NOTE

All batteries discharge during storage.

4. Recharge battery whenever the specific gravity is less than 1.225, before returning to service or every two months, whichever comes first.

COMMON CAUSES FOR BATTERY FAILURE

1. Overcharging
2. Undercharging
3. Lack of water
4. Loose hold downs and/or corroded connections
5. Excessive loads
6. Battery electrolyte substitutes
7. Freezing of electrolyte

NOTE: These failures do not constitute warranty.

BATTERY REMOVAL OR INSTALLATION



WARNING

When removing the battery, follow this order of disassembly to prevent your wrench from shorting against the frame.

1. Remove the Negative cable.
2. Remove the Positive cable.

To install a battery:

1. Attach the Positive cable.
2. Attach the Negative cable.

BOOSTER BATTERIES AND CHARGING THE BATTERY



CAUTION

Batteries can explode during boosting or charging. Always wear proper eye protection, such as safety goggles.

If the electric circuit inside the battery is broken, charging or boosting can generate a spark inside the battery which may cause it to explode.

If the battery is discharged, and the reason for the discharge is unknown and if the lights or horn do not indicate some battery voltage, check the battery with a volt meter for an open circuit. Disconnect negative (-) battery cables. Connect the volt meter across battery terminals. If there is no voltage present, an open internal circuit is indicated. Replace the battery. If voltage is present, the battery is OK to charge or boost.

If using a battery charger, be certain the charger is turned off before connecting to the battery.

Charge in a well ventilated area.

Do not attempt to charge a frozen battery.

When required, a booster 12-volt battery may be connected in parallel with the 12-volt system on the tractor.

NOTE: All circuits must be turned "OFF". The electrical system is NEGATIVE (-) ground only. Reversed polarity will result in permanent damage to components of the electrical system.

When using a booster battery with jumper cables, precautions must be taken to prevent personal injury or damage to electrical parts.

JUMP STARTING

If jump starting is necessary use only a 12 volt battery for this purpose.

1. Attach the first jumper cable from the Positive terminal of the good battery to the Positive terminal of the dead battery.
2. Attach the second jumper cable from the Negative terminal of the good battery to the **FRAME OF THE UNIT WITH THE DEAD BATTERY.**

TIRES

Keep the pneumatic tires properly inflated. Overinflation will cause operator discomfort. Underinflation will cause short tire life.

Inflate the front and rear tires for normal or heavy load operations as shown in the following table.

Tire Size	Pounds per square inch
Front Tires	
16 x 6.50-8	12 PSI
Rear Tires	
23 x 10.50-12	10 PSI

Always check that the tire valve caps are in place and tightened securely to prevent loss of air and protect the valve core and stem.

Do not overload the tractor tires by mounting equipment on the tractor which exceeds the load capacity of the size of the tires on the tractor.



CAUTION

Never inflate tires beyond 30 pounds per square inch to seat beads. Allowing air pressure to build within the assembly in an attempt to seat the beads is a dangerous practice. Inflation beyond 30 pounds per square inch pressure before seating bead may break the bead (or even the rim) with explosive force. If beads have not seated by the time pressure reaches 30 pounds per square inch, deflate the assembly, reposition the tire on the rim, re-lubricate then re-inflate. Inspect both sides of tire to be sure beads are evenly seated. If not, completely deflate tire, unseat beads and repeat entire mounting procedure. After seating beads, adjust inflation to recommended pressure.

Mounting Tires On The Rim

After mounting a new or old tire on the rim, inflate to 20 PSI pressure to seat the tire bead on the rim flange. Then deflate the tire to the correct operating pressure.

NOTE: After the first 10 hours of operation, check and retorque the rear wheels lug nuts (both sides) to 35 lbf. ft. to make sure they have seated properly.

OFF-SEASON STORAGE

If the machine is to be inoperative for a period longer than 30 days, the following procedures are recommended:

1. Remove dirty engine oil, fill with new oil and run the engine for about 5 minutes to let the oil circulate to all the parts.
2. Drain the coolant in the radiator, if tractor has water. Open the cock at the bottom of the radiator and at crank case side of engine, remove the pressure caps to drain water completely. Leave the cock open. Hang a note

written "No water" on the pressure cap. Since water may freeze when the temperature drops below 0°C (32°F), it is very important that no water is left in the machine.

3. Always set the throttle lever on "OFF" position.
4. Check all the bolts and nuts, and tighten if necessary.
5. Remove the battery from the tractor; recharge it, and adjust the electrolyte level. Store the battery in a dry and dark place. Never set directly on concrete.
6. Clean the engine and the entire tractor thoroughly.
7. Lubricate all lubrication points.
8. Protect tires and seat from sunlight. Inflate tires at regular intervals.

OPTIONAL EQUIPMENT AND ACCESSORIES

When you purchased your tractor, you probably had it completely equipped for your particular needs at the time. However, later you may wish to obtain optional equipment or accessories. These items and other allied equipment can be purchased from, and installed by, your authorized dealer.

The tractor is used for so many different types of work, and because it is called on to operate under so many different conditions, a variety of equipment is available to adapt it to the requirements of the user. Refer to equipment catalog.

MAINTENANCE CHART

Operation to be performed	Before each use	10 hours or once a month	35 hours three times a season	50 hours or twice a season	100 hours or yearly	Before storage
Clean grille (front & backside) & engine inlet air screen		More often under dirty conditions X				
Check engine oil level	X					
Fill fuel tank	X					
Change engine oil and oil filter			1st time & more often under dirty conditions		X	X
Replace transmission oil filter		After first 10 hours X		After first 50 hours X	Every 100 hours there-after	
Check battery electrolyte level		X				
Grease front axle pivot bolt		X				X
Lubricate steering knuckles (2) and steering arm		X				X
Retorque rear wheel lug bolts		After first 10 hours X				
Lubricate brake shaft			X			X
Check transmission oil level	X					
Clean cooling fins & external surfaces			X			
Service air cleaner element and dust cup	Dust Cup X				Air Cleaner Element More often under dirty conditions	
Lubricate steering gear housing					X	
Lubricate speed control linkage cam plates					X	X
Check and regrease front wheel bearings					X	
Radiator coolant level	X					X
Radiator Screen	X					

TROUBLE SHOOTING

Possible Cause

Possible Remedy

WHEN ENGINE IS DIFFICULT TO START

Fuel is thick and doesn't flow	Check if fuel shut-off valves are open. Check the fuel tank and fuel filters. Remove water, dirt and other impurities. Clean fuel filter with kerosene.
Air or water mixed in fuel system	If air is in the fuel filter or injection lines, the fuel pump will not work properly. To attain proper fuel injection pressure, check carefully for loosened fuel line coupling, loose cap nut, etc. Loosen air vent screws on base of fuel filter and fuel injection pump to eliminate all the air in the fuel oil system. Bleed fuel system, see maintenance section.
Thick carbon deposits on orifice of injection nozzle	This is caused when water or dirt is mixed in the fuel. Clean the nozzle injection piece, being careful not to damage the orifice.* Check to see if nozzle is working properly or not. If not, install a new nozzle.*
Valve clearance is wrong	Adjust valve clearance to 0.0057-0.0073 in. (0.145-0.185mm) when the engine is cold.*
Leaking valves	Grind valve.*
Fuel injection timing is wrong	Adjust injection timing. The injection timing is 21.5° (0.375 rad) before top dead center.*
Engine oil becomes thick in cold weather and engine cranks slow	Change grade of oil according to the weather (temperature).
Low compression	Bad valve or excessive wear of rings, pistons and liners cause insufficient compression. Replace with new parts.*
Battery is discharged and the engine will not crank	Charge or replace battery. Refer to battery section.

INSUFFICIENT H.P. OUTPUT

Carbon struck orifice of nozzle piece	Clean orifice and needle valve, being very careful not to damage the nozzle orifice. Check nozzle to see if good. If not, replace with new parts.*
Compression is insufficient. Leaking valves	Bad valve and excessive wear of rings, pistons and liners cause insufficient compression. Replace with new parts. Grind valves.*
Insufficient fuel to engine	Check fuel system.
Overheating of moving parts	Clean grille insert, radiator screen and radiator. Check oil level. Check for proper coolant level. Check to see if lube oil filter is working properly.* Check engine timing. Adjust timing 21.5° (0.375 rad) before top dead center.*

* See your authorized dealer.

TROUBLE SHOOTING

Possible Cause

Possible Remedy

INSUFFICIENT H.P. OUTPUT (Continued)

Valves out of adjustment	Adjust to proper valve clearance of 0.0057-0.0073 in. (0.145-0.22mm) with engine cold.*
Air cleaner element is dirty	Clean or replace with new element every 100 hours of operation.
Fuel injection pressure is incorrect	Adjust to proper pressure of 1991 psi (140 kgf/cm ² , 13.7 MPa)*
Injection pump wear	*(Do not use poor quality fuel for it will cause wear of the pump. Only use No.2-D diesel fuel. Check the fuel injection pump element and delivery valve assembly and replace as necessary.)

WHEN ENGINE SUDDENLY STOPS

Fuel leak	Check the fuel level in tank and refill if necessary. Also check the fuel system for air or leaks.
Bad nozzle	If necessary, replace with a new nozzle.*
Moving parts are overheated due to shortage of lube oil or improper lubrication	Check engine level. Check to see if element inside the lubricating oil filter (2) has become old and clogged. If necessary, replace with new element.

WHEN COLOR OF EXHAUST IS SPECIALLY BAD

When engine is operating properly, the exhaust is nearly colorless.

Fuel governing device bad	Contact dealer for repairs.*
Fuel is of extremely poor quality	Select good quality fuel oil. No.2-D diesel only.
Nozzle is bad	If necessary replace with new nozzle.*
Combustion is incomplete	Cause is poor atomization, improper injection timing, etc. because of trouble in injection system or in poor valve adjustment, or compression leakage, poor compression, etc. Check for the cause.*

ENGINE MUST BE STOPPED IMMEDIATELY IF ANY ONE OF THE FOLLOWING CONDITIONS APPLY

Speed suddenly decreases or increases	Check the adjustments and timing of injection and the fuel system.*
Unusual sound is heard suddenly	Check all moving parts carefully.
Color of exhaust suddenly turns dark	Check the fuel injection system, especially the fuel injection nozzle.*
Bearing parts are overheated	Check the oil level.
Oil lamp lights up during operation	Check oil level. Check the function of the regulating valve inside of oil filter (2).* Check pressure switch.* Check filter base gasket for leaks.

*See your authorized dealer.

SPECIFICATIONS

CAPACITIES	
Fuel Tank	4 Gals. (15.1L)
Crankcase	98.4 oz. (6.2 pts.) including oil in filter.
Transmission case with Hydro-drive unit mounted	7 Qts. (6.6L)
Steering gear housing	¼ Lb. (0.1 Kg)
HYDROSTATIC DRIVE	
Speed: Forward	0 to 8.64 mph (0 to 13.824 Km/H)
Reverse	0 to 4.25 mph (0 to 6.800 Km/H)
ENGINE	
See separate engine manual	Kubota—D600-B
ELECTRICAL SYSTEM	
System voltage	12 volt neg. ground
Battery	39 AH, 12 Volt—1 HPRLU
Alternator	15 amp
Circuit breaker	40 amp
Headlights	
all glass, sealed beam units	Lamp No. H7610
Taillight	Lamp No. 194
BRAKES	
	Dual disc, external
TIRE SIZES	
Front	16 x 6.50-8
Rear	23 x 10.50-12

Specifications are subject to change without notice.

LUBRICATION TABLE

Point of Lubrication	Check at Hours	Change at Hours	Capacity (6.2 pts.)	Anticipated Air Temperature		
				Above +77°F.	+32°F. to 77°F.	Below 32°F.
Engine crankcase	Check before each	35 and 100	98.4 oz. including oil in oil filter.	Engine Oil SAE-30	Engine Oil SAE-20W or SAE-15W-40	Engine Oil SAE-10 or SAE-10W-40
Hydro-drive unit mounted on transmission case with filter	30	Add as needed	14 pt. Approx.	IH Hy - Tran® Fluid If fluid is used which does not meet requirements of IH B-6 Specifications, Cub Cadet will not be responsible for substandard performance. Failures due to use of improper fluid are not covered by warranty. For maximum protection, use IH Hy - Tran® Fluid.		
Steering gear housing	100 or Yearly		¼ lb.	Two strokes of the lubricator using IH-251H EP grease or equivalent No. 2 multi-purpose lithium grease.		
Steering knuckles & front axle pivot bolt	10			Use IH-251H EP grease or equivalent No. 2 multi-purpose lithium grease and apply two or three strokes of the lubricator or sufficient grease to flush out old grease and dirt.		
Front wheel bearings	100 or Yearly			Remove front wheels and pack bearings with IH-251H EP grease or equivalent No. 2 multi-purpose lithium grease and reinstall wheels.		

LUBRICATION GUIDE

The life of any machine depends upon the care it is given. Proper lubrication is a very important part of that care.

Be certain that all lubrication fittings are assembled in place, using the lubrication illustrations as a guide.

Always lubricate the tractor thoroughly before taking it to the field. Use a pressure lubricating gun.

Be sure all fittings are free from dirt and paint so the lubricant is certain to enter the bearing.

Keep your supply of lubricating oil and grease stored in clean containers, and covered to protect from dust and dirt.

Keep the lubricating gun nozzle clean and wipe dirt from grease fittings before lubricating.

The symbols in the illustration indicate the method of application and the hourly intervals to apply the lubricant.



Use a pressure lubricating gun and apply IH 251H EP grease (or equivalent No. 2 multi-purpose lithium grease) sufficient to flush out the old grease and dirt. Lubricate at hourly intervals indicated on symbols.



Dipstick, use to check engine oil before each use.



CAUTION

Prolonged or repeated skin contact with used motor oil may be harmful. Wash skin with soap and water.

LUBRICATION GUIDE

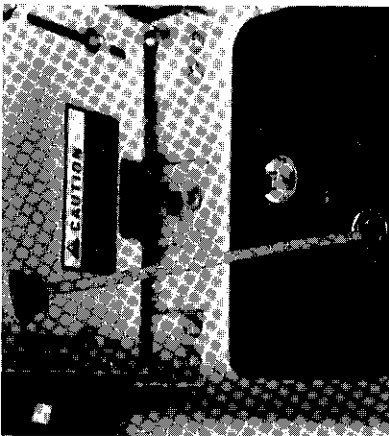

300
6

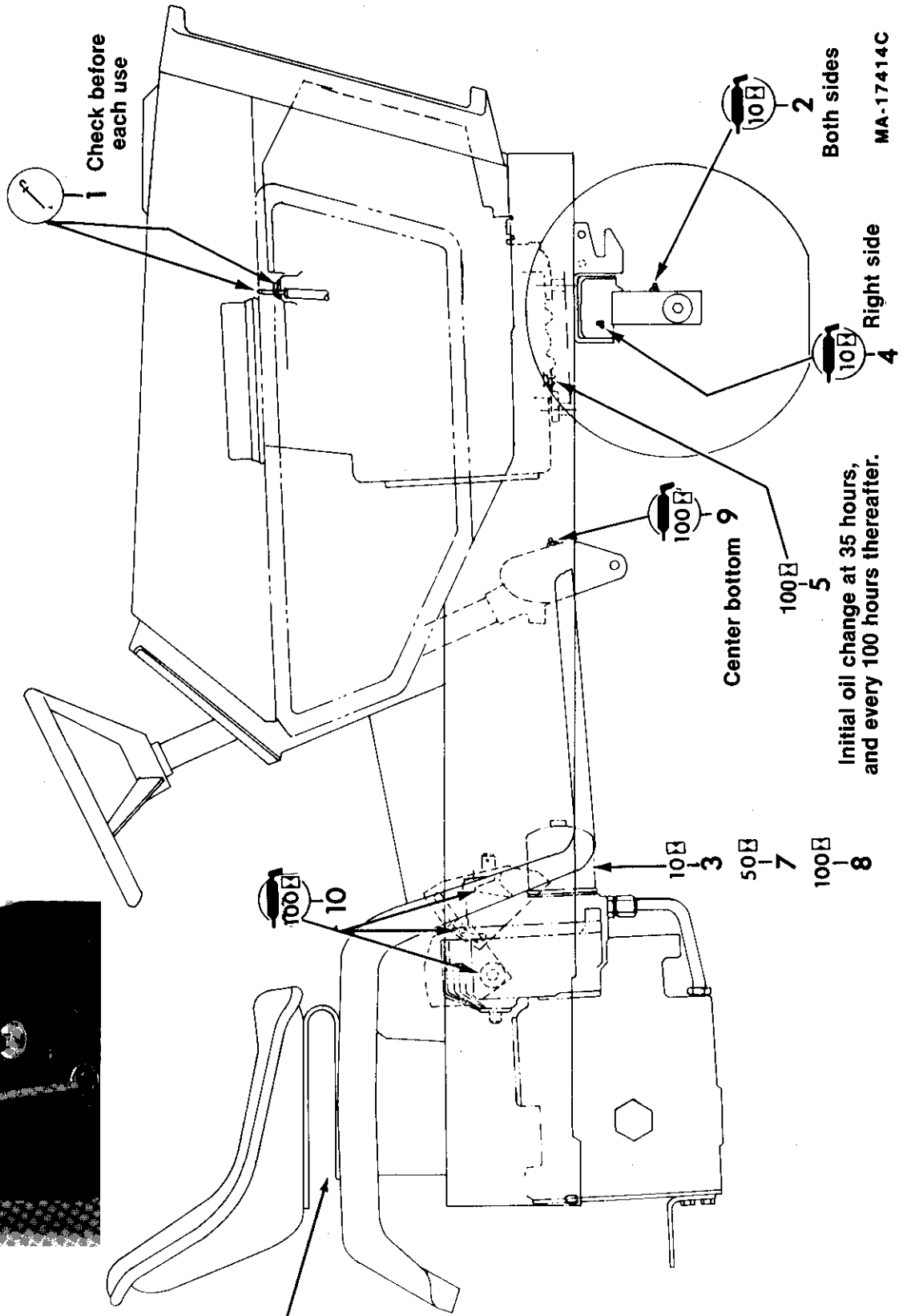

LUBRICATION GUIDE

—Before Each Use

1—Engine dipstick.

Check the oil (with the engine stopped) and add sufficient new oil to bring it to the “**FULL**” mark on the dipstick. Do not overfill. Do not operate the engine if the oil level is below the “**LOW**” mark on the dipstick.

—After Every 10 Hours of Operation

2—Steering Knuckles (2).
(Both sides)

Use IH 251H EP grease or equivalent No. 2 multi-purpose lithium grease and apply sufficient grease to flush out old grease and dirt.

3—Transmission oil filter.

NOTE: after the first 10 hours only, remove the oil filter and replace with a new filter. Change the oil filter after 50 hours and every 100 hours of operation thereafter.

4—Front Axle pivot bolt.
(Right side)

Use IH 251H EP grease or equivalent No. 2 multi-purpose lithium grease and apply sufficient grease to flush out old grease and dirt. **NOTE:** It may be necessary to rotate the front axle to reach the grease fitting.

—After Every 35 Hours of Operation

5—Engine oil drain plug,
and engine oil filter.

After the first 35 hours only, and 100 hours thereafter, while the oil is warm, remove the drain plug (5) and drain all of the oil from the crankcase. Replace the drain plug. Refill the crankcase with new oil up to the “**FULL**” mark on the oil level gauge. Refer to the “**LUBRICATION TABLE**” for the proper quantity and viscosity to use. Replace engine oil filter every time oil is changed.

6—Transmission oil level
dipstick and filler tube.

Check the oil with the engine stopped. Keep the lubricant up to full mark on dipstick.

—After Every 50 Hours of Operation

7—Transmission oil filter.

NOTE: After the first 50 hours only, remove the oil filter and replace with a new filter. Refer to “**MAINTENANCE**”. Change the oil filter every 100 hours of operation thereafter. Add Hy-Tran oil as necessary for proper level.

—Every 100 hours of Operation

8—Transmission oil filter.

Change the oil filter and replace with a new filter. Refer to “**MAINTENANCE**”.

9—Steering gear housing.
(Center bottom)

Once a year or every 100 hours, apply two strokes of the lubricator, using IH 251H EP grease or equivalent No. 2 multi-purpose lithium grease.

NOTE: To locate the lubrication fitting, turn the front wheels to the maximum right turn position. Then reach up under the right side of the tractor frame to locate the fitting.

Speed Control Linkage

10—Cam plates.

Once a year, apply a small amount of IH 251H EP grease or equivalent No. 2 multi-purpose lithium grease in the slots.

Miscellaneous

Brake pedal shaft.

Lubricate the brake pedal shaft and linkage with eight or ten drops of engine oil.

STANDARD TORQUE DATA FOR INCH NUTS AND BOLTS — FOOT POUNDS

Recommended torque for all Standard Unplated Nuts and Bolts, provided:

- A. Surface finish is oxide coated, oil quenched or bright.
- B. All thread surfaces are clean and lubricated with SAE-30 engine oil or equivalent (See NOTE.)
- C. Joints are rigid, that is, no gaskets or compressible materials are used.
- D. When reusing nuts or bolts use minimum torque values.

NOTE: Multiply the standard torque by:
 .65 when finished jam nuts are used.
 .70 when Molykote, white lead or similar mixtures are used as lubricants.
 .75 when phosphate coated and oiled bolts or nuts are used.
 .85 when cadmium or zinc dichromate bolts or nuts are used.
 .90 when hardened surfaces are used under the nut or bolt head (this applies to standard unplated hardware only).

1 FOOT POUND = 1.355 NEWTON METERS

Bolt or Stud Diameter	Type 1 Studs Only		Type 1 Bolts 6" length or less		Type 1 Bolts longer than 6"		Type 5 (all lengths)		Type 8 (all lengths)			
	Min.	Max.	Min.	Max.	Min.	Max.	Min.	Max.	Only when used † in cast (gray) iron		All other applications	
Inches									Min.	Max.	Min.	Max.
1/4	5	6	6	7	4	4	9	10	11	13	13	14
5/16	12	13	11	13	7	8	18	20	22	25	25	28
3/8	21	24	21	24	13	14	33	37	41	46	45	50
7/16	35	38	35	38	20	23	53	60	66	74	75	86
1/2	52	58	52	59	31	35	80	90	100	112	115	130
9/16	70	80	75	85	45	51	115	130	145	160	165	185
5/8	98	110	104	117	62	70	160	180	200	225	225	255
3/4	174	195	185	205	110	125	285	320	355	400	400	450
7/8	280	315	180	200	180	200	460	575	570	640	645	725
1	420	470	265	300	265	300	685	720	855	960	970	1080
1-1/8	595	670	380	425	380	425	850	950	1210	1360	1375	1545
1-1/4	840	945	535	600	535	600	1200	1350	1705	1920	1940	2180
1-3/8	1100	1240	700	785	700	785	1570	1760	2235	2515	2540	2860
1-1/2	1470	1640	925	1045	925	1045	2080	2340	2970	3340	3375	3785

†When bolt penetration is 1-1/2 times the diameter of the bolt.

BOLT TYPE IDENTIFICATION CHART

IH TYPE	S.A.E. GRADE	DESCRIPTION	BOLT HEAD MARKING*
1	1 or 2 <small>EQUIVALENT</small>	WILL HAVE A STANDARD MONOGRAM IN THE CENTER OF THE HEAD Low or Medium Carbon Steel Not Heat Treated	
5	5	WILL HAVE A AND 3 RADIAL LINES Quenched and Tempered Medium Carbon Steel	
8	8	WILL HAVE A AND 6 RADIAL LINES Quenched and Tempered Special Carbon or Alloy Steel	

*The center marking identifies the bolt manufacturer.







INCH-METRIC HARDWARE

NOTE: This machine contains both inch and metric hardware. Be sure to use the correct inch or metric size and type (class) hardware when replacing or when mounting attachments to tapped holes. Also, use the correct inch or metric tools with each kind of hardware.

The following chart is provided to further help identify an approximate size in inch or metric hardware. **THIS IS NOT A RECOMMENDATION FOR SUBSTITUTION, AND THEY ARE NOT INTERCHANGEABLE.** This chart is only a means of quickly determining the approximate size.

The following chart is provided to help you distinguish between inch and metric hardware by observing the head markings.

BOLT CLASSIFICATION AND IDENTIFICATION CHART

INCH			METRIC	
SAE GRADE	IH GRADE	BOLT HEAD MARKINGS	CLASS	BOLT HEAD MARKINGS
2	1		5.8	
5	5		8.8	
8	8		10.9	

Metric Series mm	Approximate Inch Series
6	1/4
8	5/16
10	3/8, 7/16
12	1/2
14	9/16
16	5/8
18	
20	3/4
22	7/8
24	1
27*	1
30	1-1/8, 1-1/4
36	1-1/2

* Non-preferred

If there are any further questions, see your International Harvester dealer.

(8-81)

INTERNATIONAL HARVESTER COMPANY
401 NORTH MICHIGAN AVE. / CHICAGO, ILLINOIS 60611 / U.S.A.

1096 858 R1 2-84.
PRINTED IN UNITED STATES OF AMERICA
772-3456